



IANA Stewardship Transition & Enhancing ICANN Accountability

Panel and Audience discussion | WSIS Forum | 5 May 2016

What is ICANN?



The Internet Corporation for Assigned Names and Numbers (ICANN) is a multistakeholder, private sector-led organization that manages Internet resources for the public benefit

- ⦿ ICANN helps coordinate the top-level of the Internet's system of unique identifiers via global, multistakeholder, bottom-up consensus policy processes, with the outcome of those processes implemented via the IANA Functions.

What are the IANA Functions?

The IANA Functions evolved in support of the Internet Engineering Task Force, and initially funded via research projects supported by the U. S. Department of Defense, Advance Research Projects Agency.

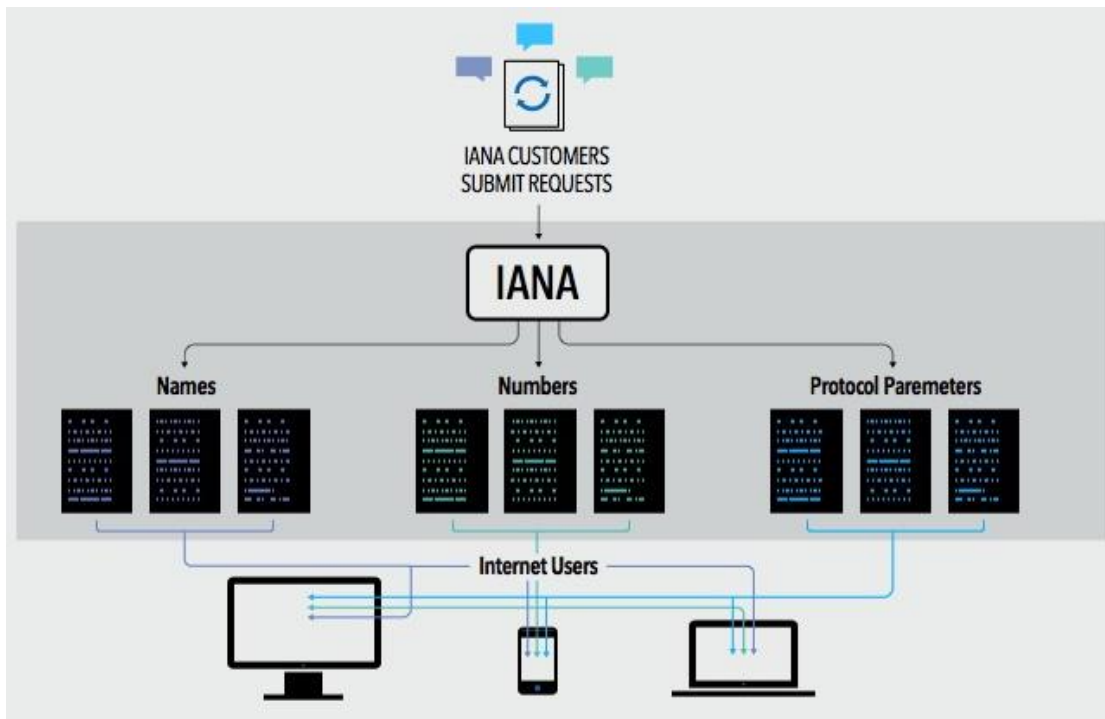

These functions include:

- ⦿ The coordination of the assignment of technical Internet protocol parameters
- ⦿ The administration of certain responsibilities associated with Internet DNS Root zone management
- ⦿ The allocation of Internet IP addresses

ICANN was created to perform the IANA Functions and has done so pursuant to a no-cost contract with the Department of Commerce for over 15 years

What is the multistakeholder community?

“Stakeholder” refers broadly to anyone who has an interest in the Internet

Within ICANN, stakeholders include:



Large and
small
businesses



Technical
community



Civil society



Governments



Researchers
and academics



End users

The multistakeholder community functions on bottom-up consensus building which, by design, is resistant to capture due to the openness, diversity and equal division of authority among participants

ICANN’s private sector-led multi-stakeholder community supports the success of the Internet’s DNS

The U.S. Government's Announcement

14 March 2014: U.S. Government announces intent to transition its stewardship of the IANA functions to the global multistakeholder community

- ⦿ Asked ICANN to convene global stakeholders to develop a proposal
- ⦿ The multistakeholder community has set policies implemented by ICANN for more than 15 years



Why
now?

The U.S. Government's announcement:

- ⦿ Marks the final phase of the privatization of the DNS
- ⦿ Further supports and enhances the multistakeholder model of Internet policy making and governance

ICANN was asked to serve as a facilitator, based on its role as the IANA functions administrator and global coordinator for the Internet's Domain Name System (DNS)

Two Parallel Processes

The community developed and is following two parallel processes:

IANA Stewardship Transition

Focused on delivering a proposal to transition the stewardship of the IANA functions to the multistakeholder community

Enhancing ICANN Accountability

Focused on ensuring that ICANN remains accountable in the absence of its historical contractual relationship with the U.S.

To drive the processes, the community created **multilayered, transparent** and **diverse** working groups to foster discussion and within those groups, has developed working methods and systems for determining consensus

Developing Proposals

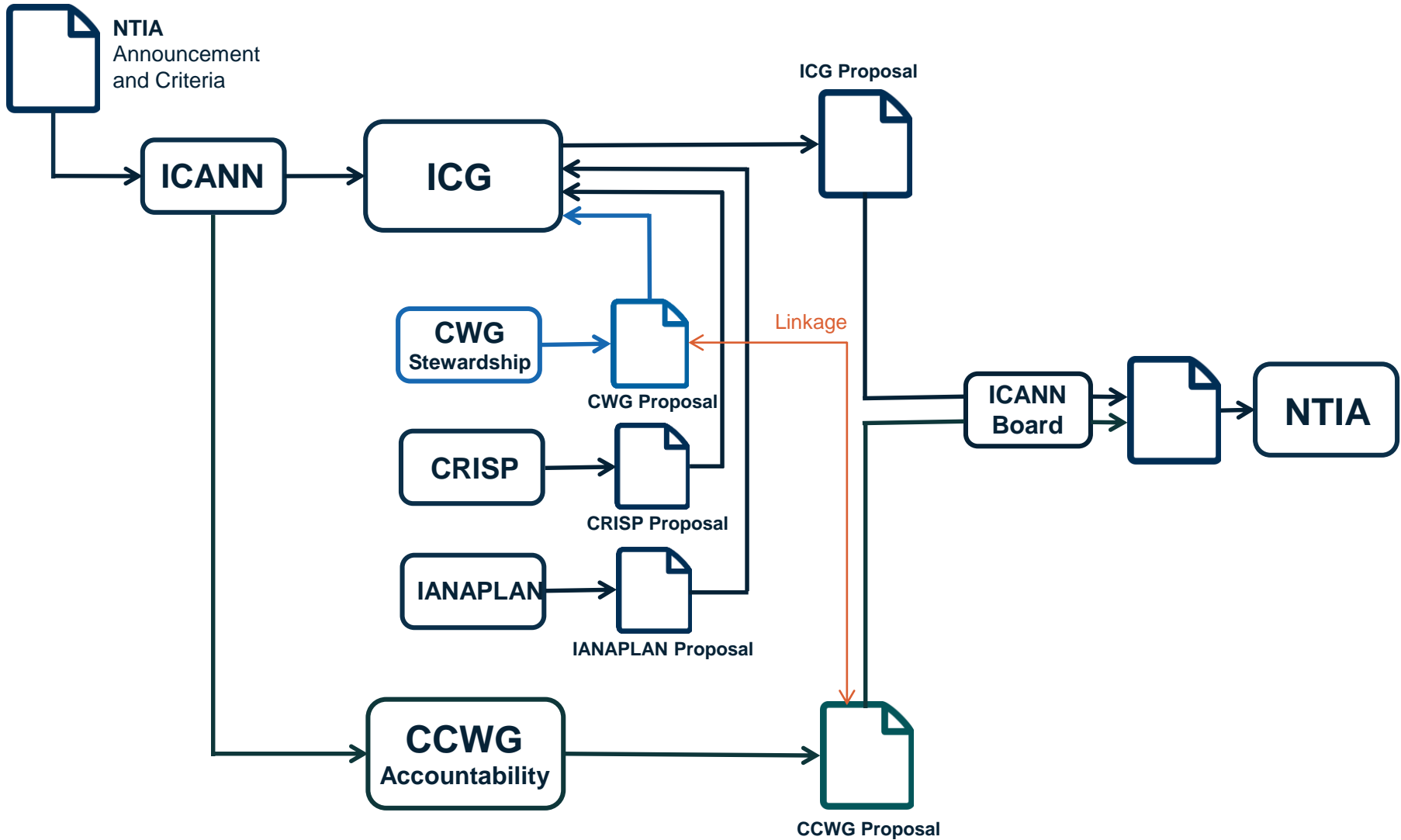

An Unprecedented Multistakeholder Effort

MAJOR WORKING GROUP EFFORTS



800+

Working Hours in Meetings



33,100+

Total Mailing List Exchanges



600+

Total Calls/Meetings

A SUPPORTING GLOBAL DISCUSSION

More than
1,100

* 590+ Webinars

Events around the world where the IANA transition was discussed, debated, organized and planned

Between March 2014 and March 2016

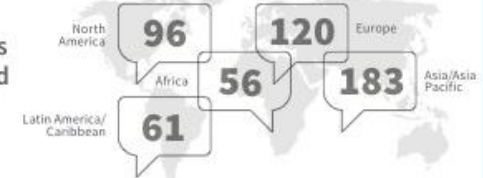

ICG + CCWG ACCOUNTABILITY

ICG

CCWG-Accountability

30
Members

203
Total Participants

28
Members

175
Participants

111
Mailing List Observers

Number Resources
CRISP Team

15
Members
= 3 Members x 5 RIRs

Protocol Parameters
IANAPLAN

2,250
Mailing List Exchanges

Domain Names
CWG-Stewardship

153
Members &
Participants

152
Calls and Meetings

REGIONAL REPRESENTATION



ORGANIZATIONAL STAKEHOLDER REPRESENTATION



THE TWO PARALLEL PROCESSES

IANA Stewardship Transition

Enhancing ICANN Accountability for the Transition

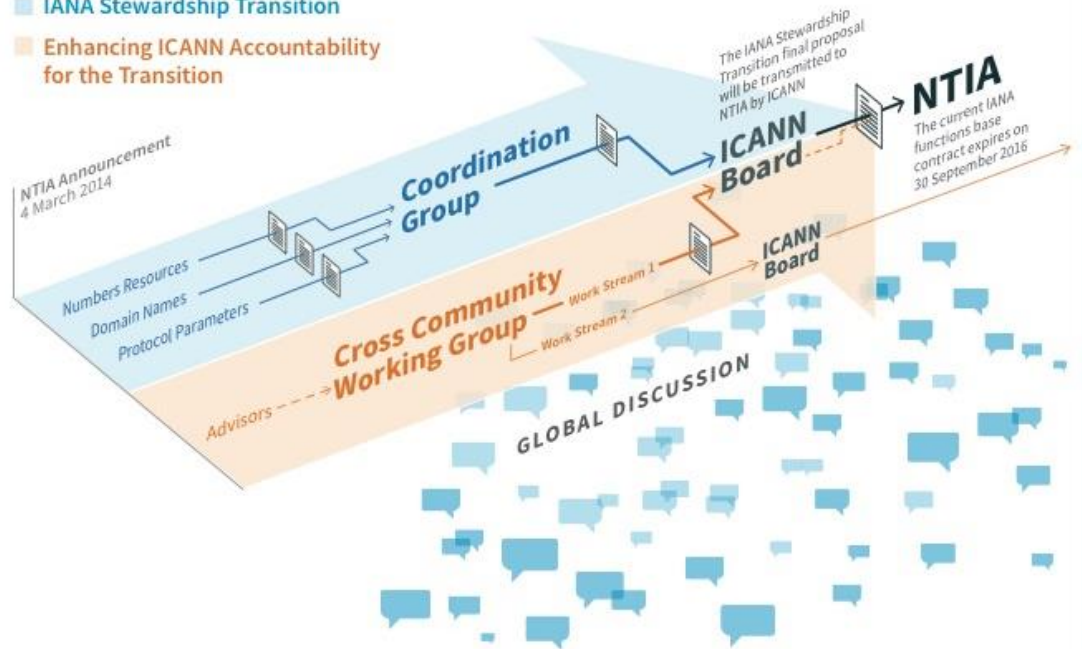



IANA STEWARDSHIP TRANSITION

Proposal Overview

Current Contract

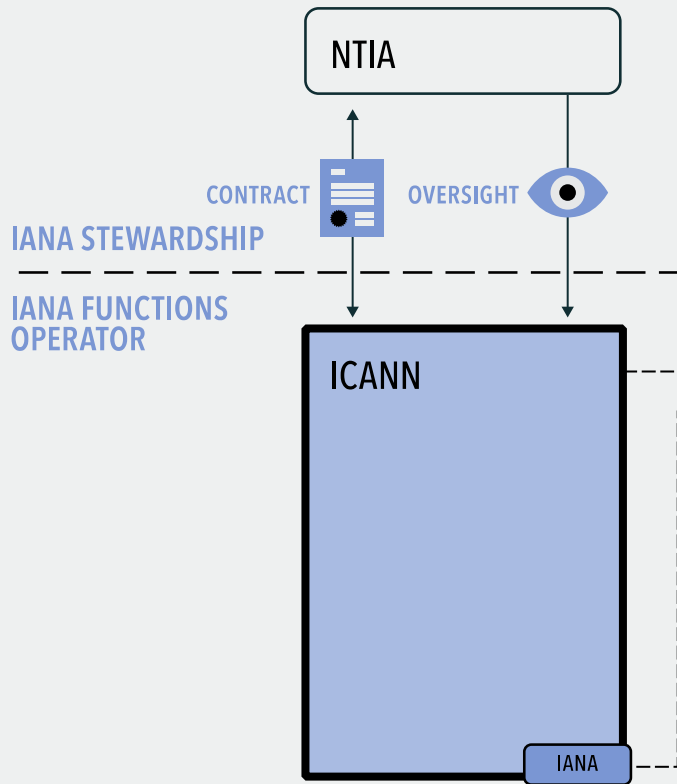

Post-transition

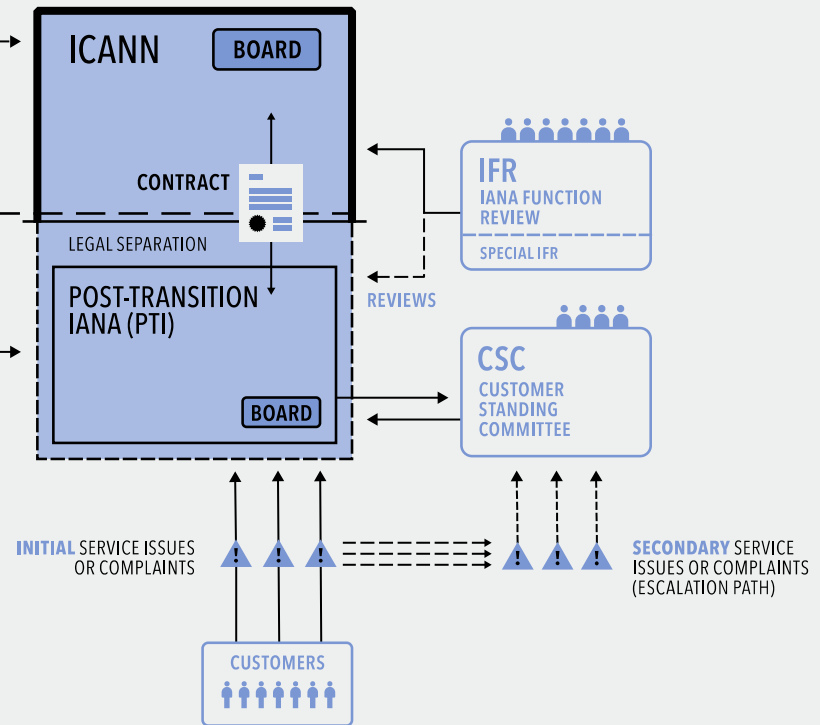

Combined Proposal Overview

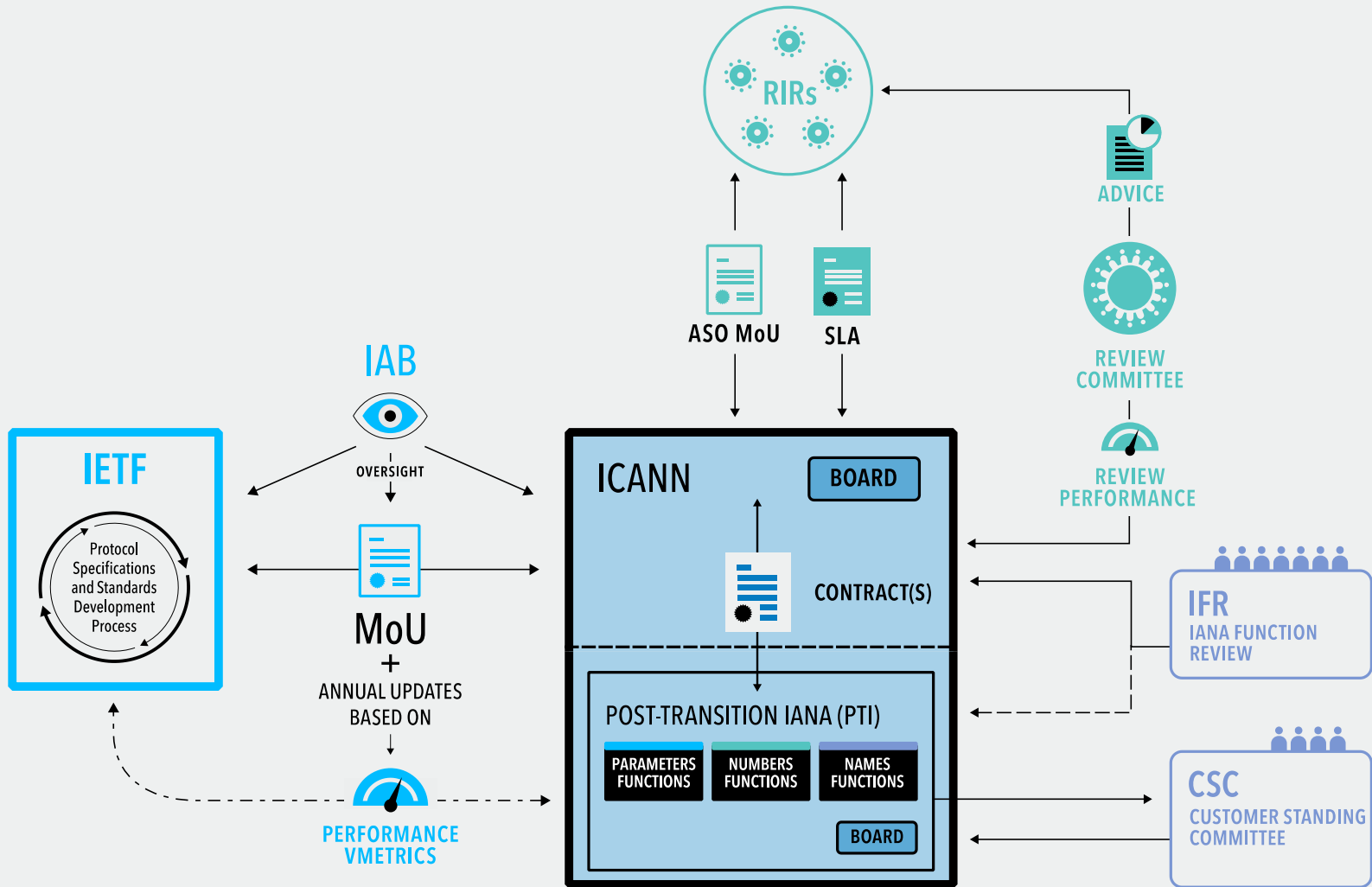



ENHANCING ICANN ACCOUNTABILITY

Work Streams

To address accountability concerns raised during initial discussions on IANA Stewardship Transition, a Cross Community Working Group on Enhancing ICANN Accountability (CCWG-Accountability) was convened.

GOAL: The CCWG-Accountability is expected to deliver proposals that would enhance ICANN's accountability towards all its stakeholders

The CCWG-Accountability's work consists of two tracks:

WORK STREAM 1: Focused on mechanisms enhancing ICANN accountability that must be in place or committed to within the time frame of the IANA Stewardship Transition.

WORK STREAM 2: Focused on addressing accountability topics for which a timeline for developing solutions and full implementation may extend beyond the IANA Stewardship Transition.

CCWG-Accountability

From December 2014 - March 2016, the CCWG-Accountability developed a set of proposed enhancements to ICANN's accountability to the global Internet community. This document was distributed for the consideration and approval of the working group's 6 Chartering Organizations.

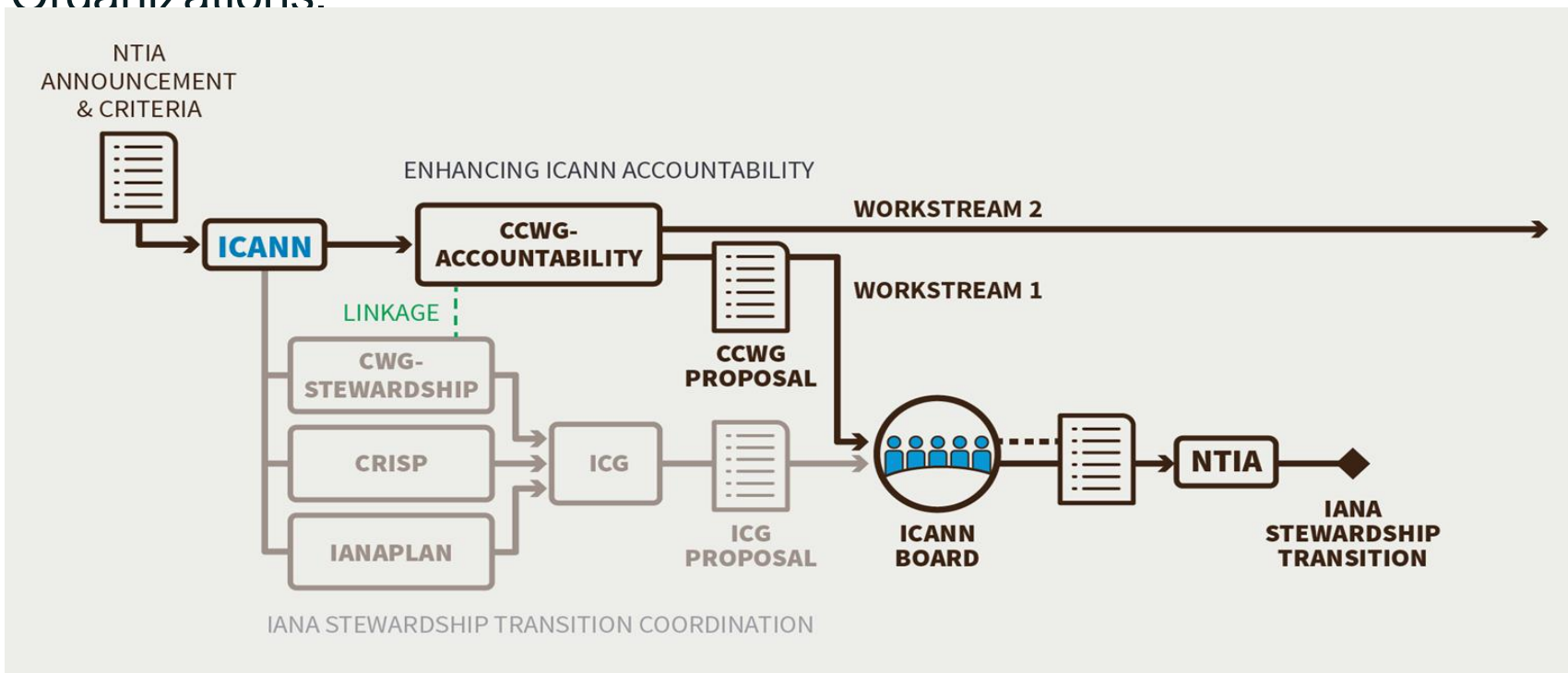

Four Building Blocks

The CCWG-Accountability identified four building blocks that would form the mechanisms required to improve ICANN's accountability.

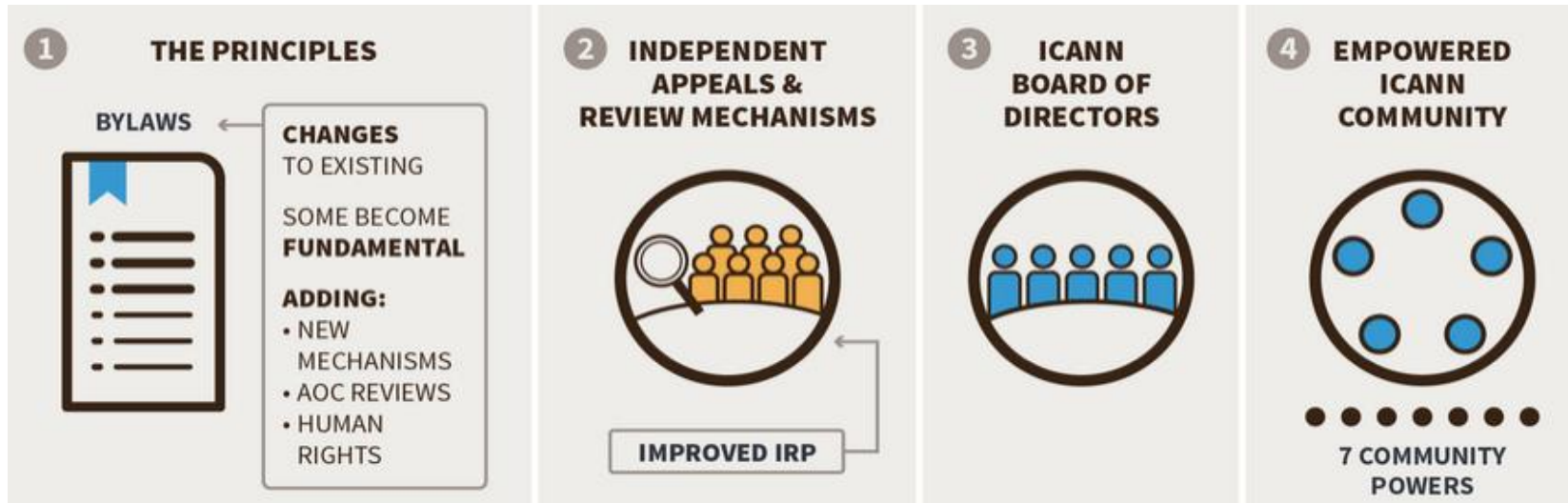

Principles / Mission

- ⦿ Limited scope of what ICANN can do; no “content regulation”
- ⦿ Updated definition of role for Domain Names, Numbering Resources and Protocol Parameters
- ⦿ Incorporate Affirmation of Commitment (AoC) reviews
- ⦿ Commitment to Human Rights

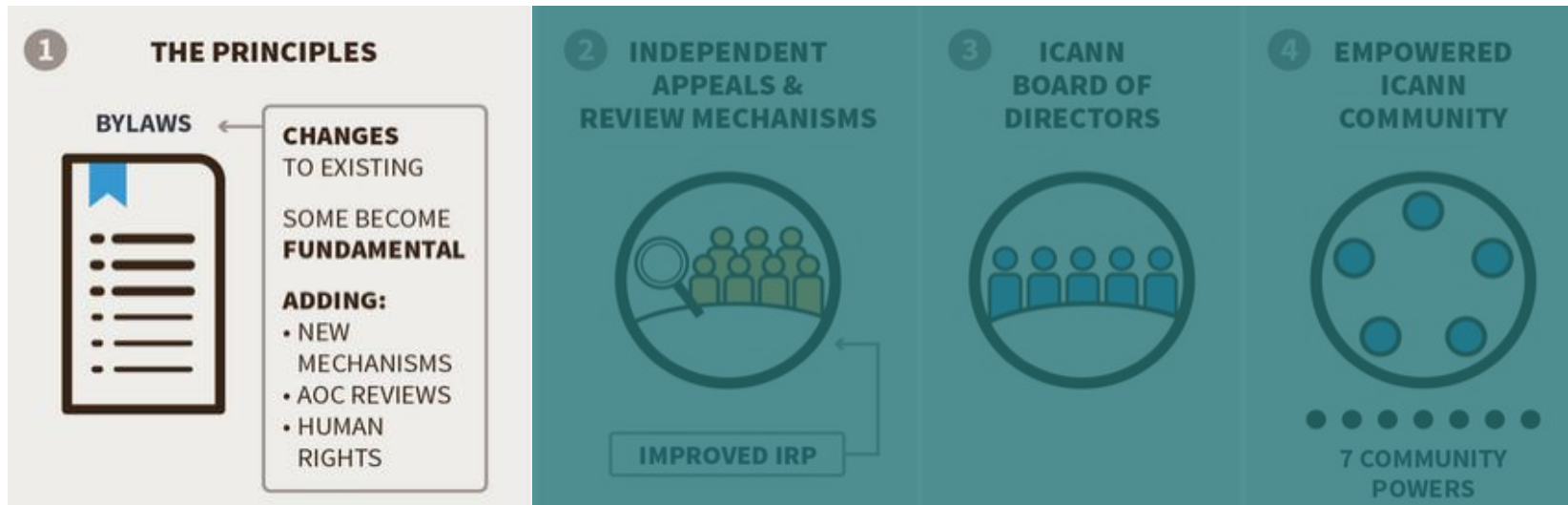

Independent Appeals & Review Mechanisms

- An enhanced Independent Review Process and redress process with a broader scope and the power to ensure ICANN stays within its Mission
- A community Independent Review Process as an enforcement mechanism further to a Board action or inaction

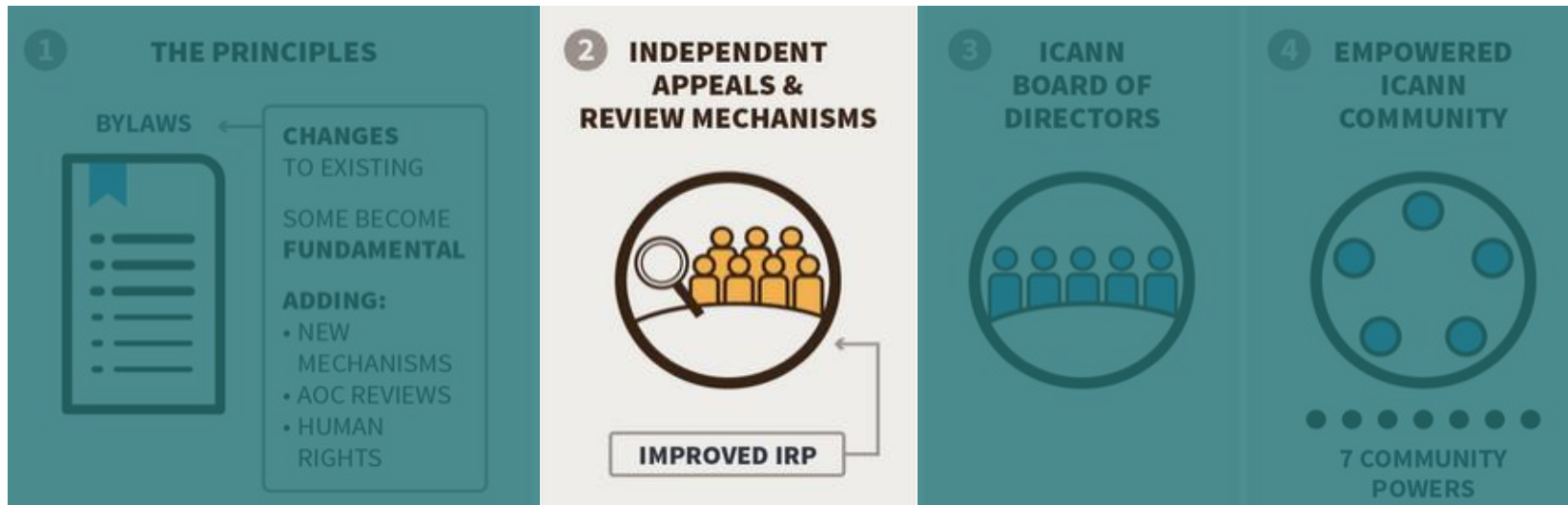

ICANN Board of Directors

- Clarify Board obligations with regards to consideration of Advice provided by the Governmental Advisory Committee (GAC)
- Include the review of Supporting Organization and Advisory Committee accountability mechanisms in the independent structural reviews performed on a regular basis

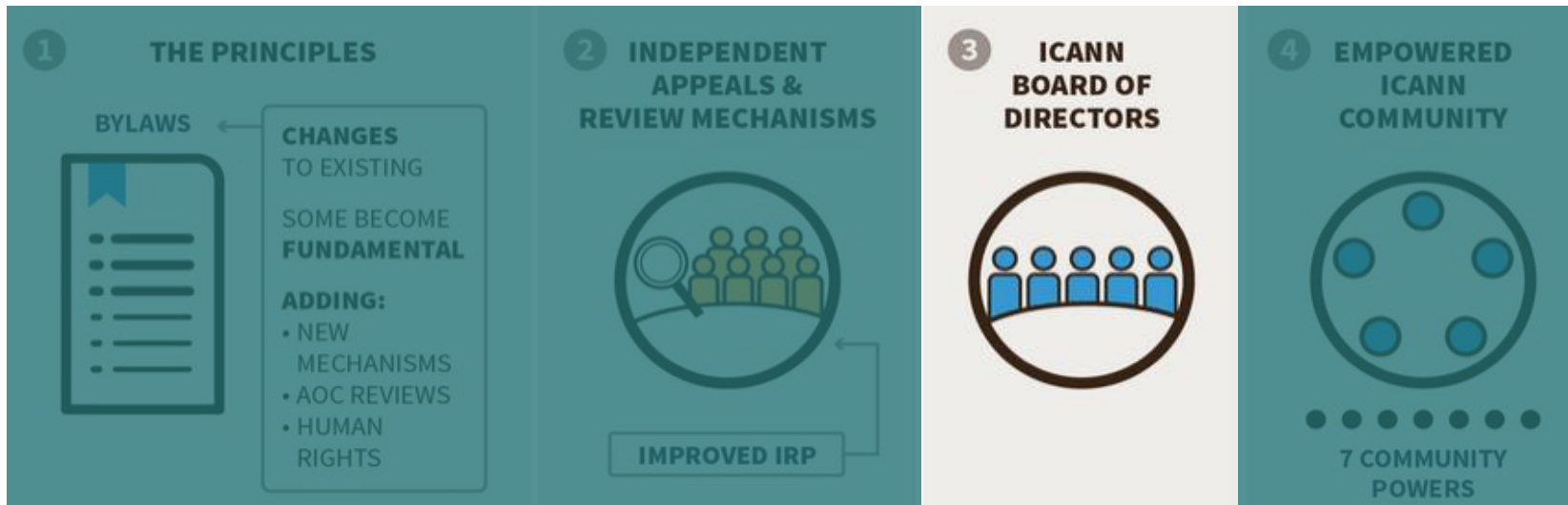

Empowered ICANN Community

- Powers exercised by five groups within the ICANN community, recognized as a “Sole Designator”
- Strong focus on Engagement and Escalation, before Enforcement

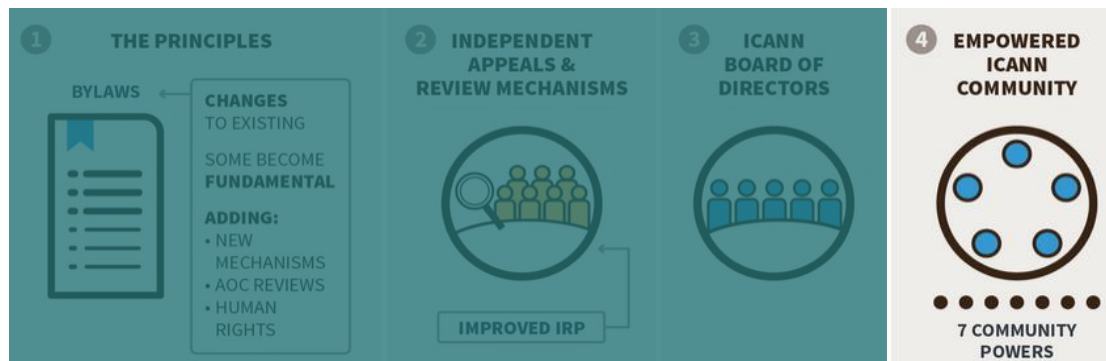
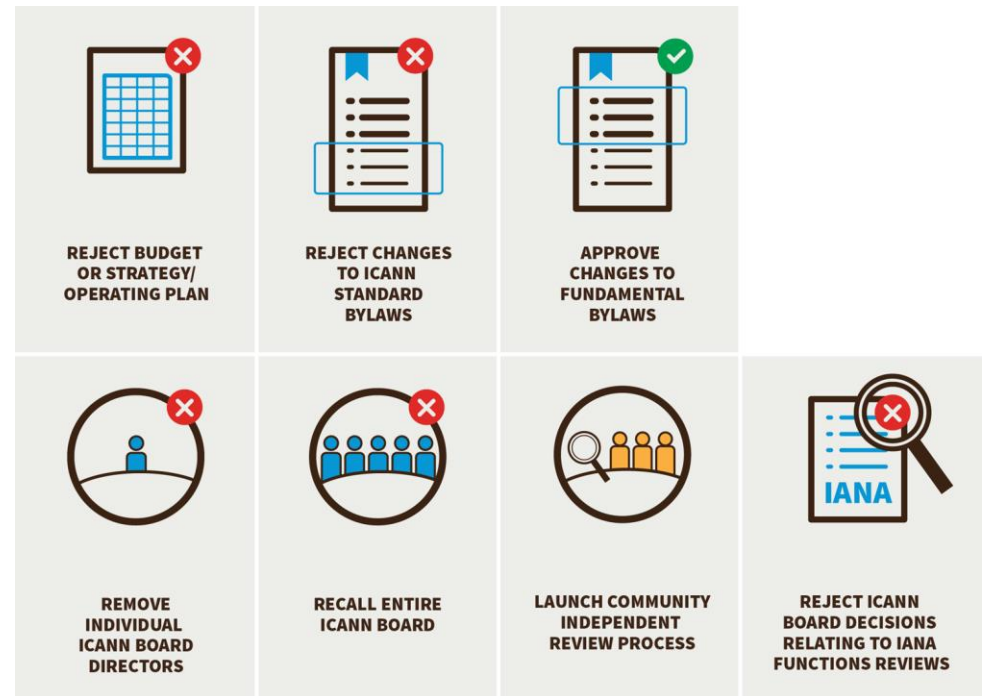

A Look Ahead: Phases 2 and 3

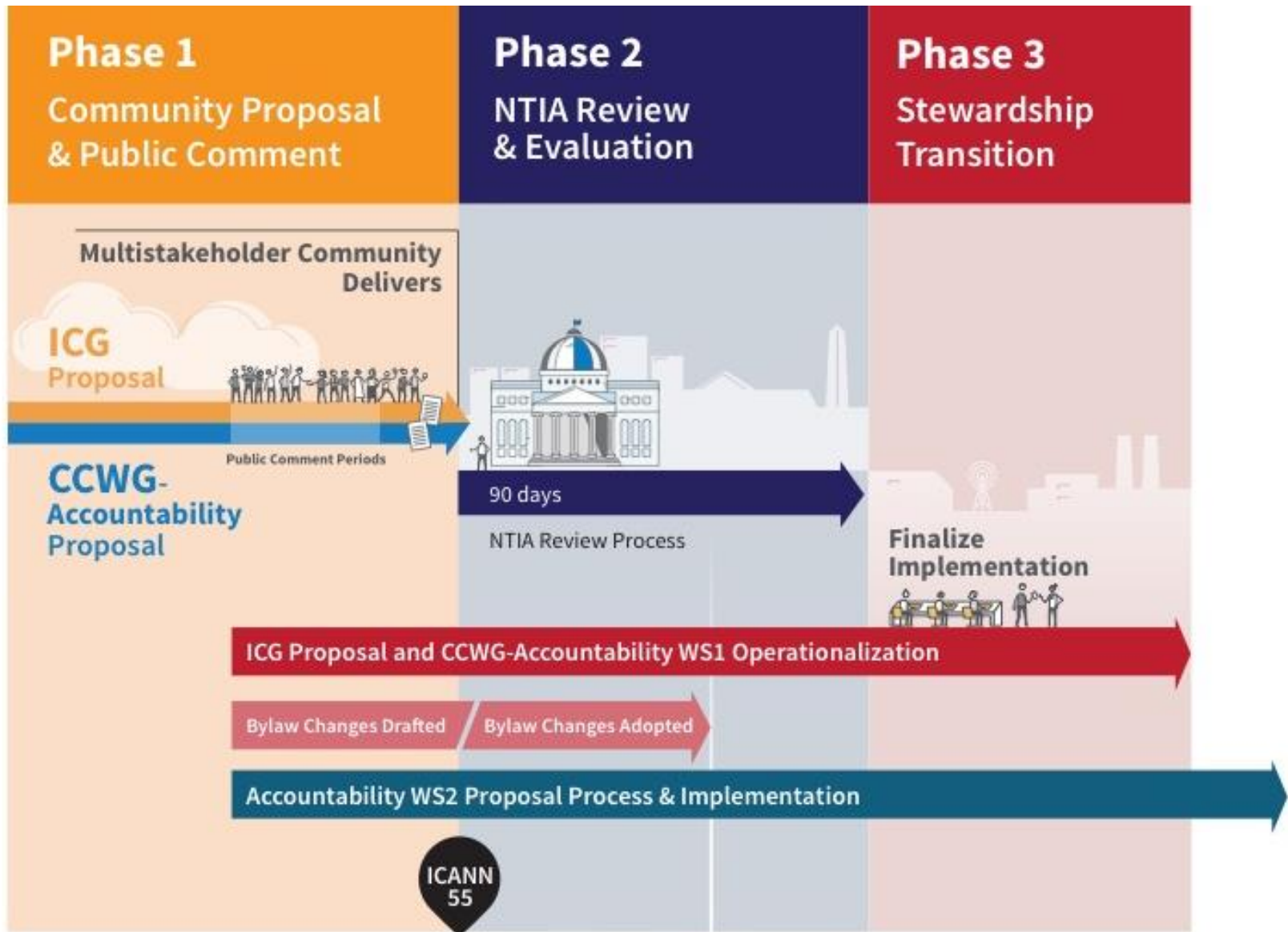

Committing to Further Accountability Work in Work

The CCWG-Accountability's work consists of two Work Streams:

WORK STREAM 1: Focused on mechanisms enhancing ICANN accountability that must be in place or committed to within the time frame of the IANA Stewardship Transition
(COMPLETED)

WORK STREAM 2: Focused on addressing accountability topics for which a timeline for developing solutions and full implementation may extend beyond the IANA Stewardship Transition
(IN PROGRESS)

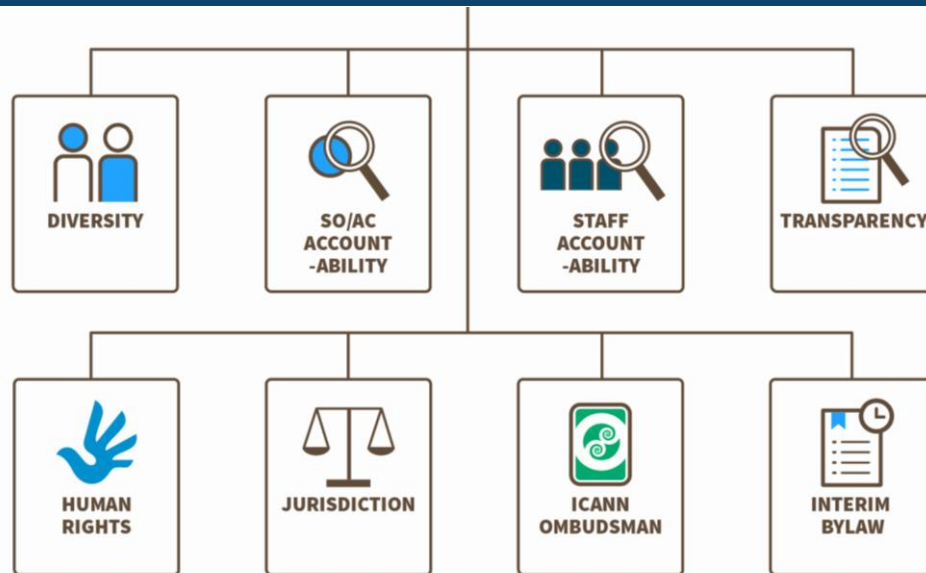

What Can I Do Now To Get Involved?



Join a working group

- ⦿ CCWG-Accountability, contact acct-staff@icann.org



Participate in a public comment period

Participating in public comment periods is an integral part of ICANN's inclusive and bottom-up model of proposal development



Stay up to date on recent developments

- ⦿ Visit: <https://www.icann.org/stewardship-accountability>
- ⦿ Follow [@ICANN](#) on Twitter or like [ICANN](#) on Facebook
- ⦿ [Subscribe](#) to ICANN news alerts

Questions?



Thank You and Questions

Website: <https://www.icann.org/stewardship-accountability>



twitter.com/icann



facebook.com/icannorg

IANA Stewardship Transition

<https://www.icann.org/stewardship>

- ⦿ Latest news and information on the IANA Stewardship Transition and ICG
- ⦿ Community participation information
- ⦿ Resources and archives from ICG meetings

Enhancing ICANN Accountability

<https://community.icann.org/category/accountability>

- ⦿ Latest news and information on the Enhancing ICANN Accountability process and CCWG
- ⦿ Announcements and upcoming events