



ICANN | 53   
*Buenos Aires*

21-25 JUNE 2015

CWG-Stewardship/CCWG-Accountability  
**Joint Townhall Meeting**

22 June 2015



A world map where the continents are defined by a complex network of white dots and thin white lines. The dots vary in size, and the lines connect them to form a web-like structure. The background is a solid dark blue color.

CWG-Stewardship



# Statistics and Diversity

 **19**  
Members

 **133**  
Participants

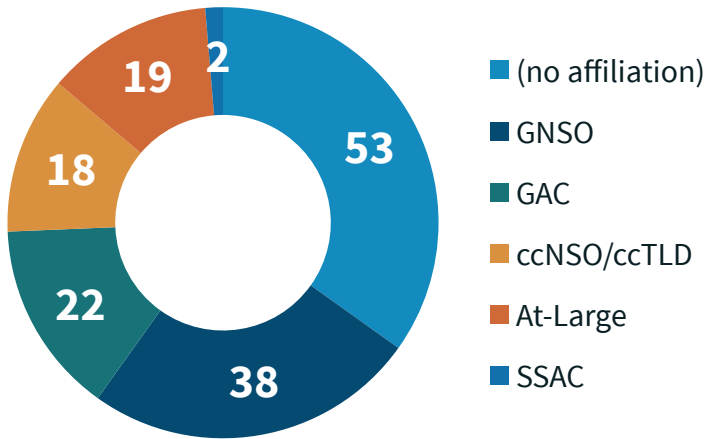

**101**  
Calls/Meetings



**4,893**  
Volunteer Hours



**4000+**  
Mailing List  
Messages



**35**  
Average # per  
Plenary Meeting

# Part of a Process

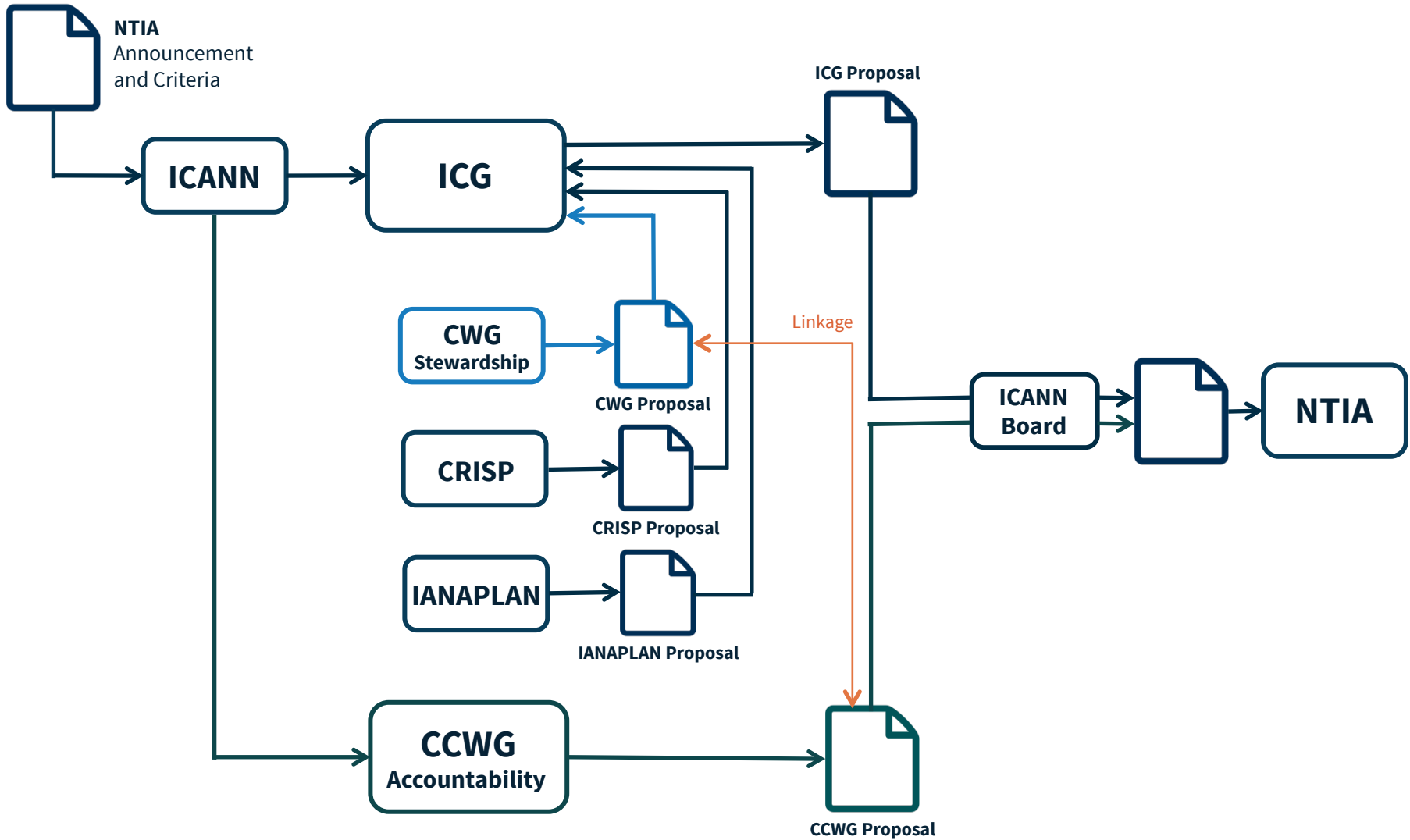

# Goals and Requirements

## Goal:

Produce a consolidated transition proposal for the elements of the IANA Functions relating to the Domain Name System.

## A transition proposal for the Domain Names community would require:



A contract similar to the current IANA functions contract



A mechanism to approve changes to the Root Zone environment



Accountability mechanisms on ICANN with respect to the IANA functions



The ability to ensure adequate funding of the IANA Functions by ICANN



Additional insulation between operational and policymaking responsibilities and protections for the IANA Functions Operator



The ability for the multistakeholder community to require the selection of a new operator for the IANA Functions, if necessary

# Structural Overview

## Current Contract

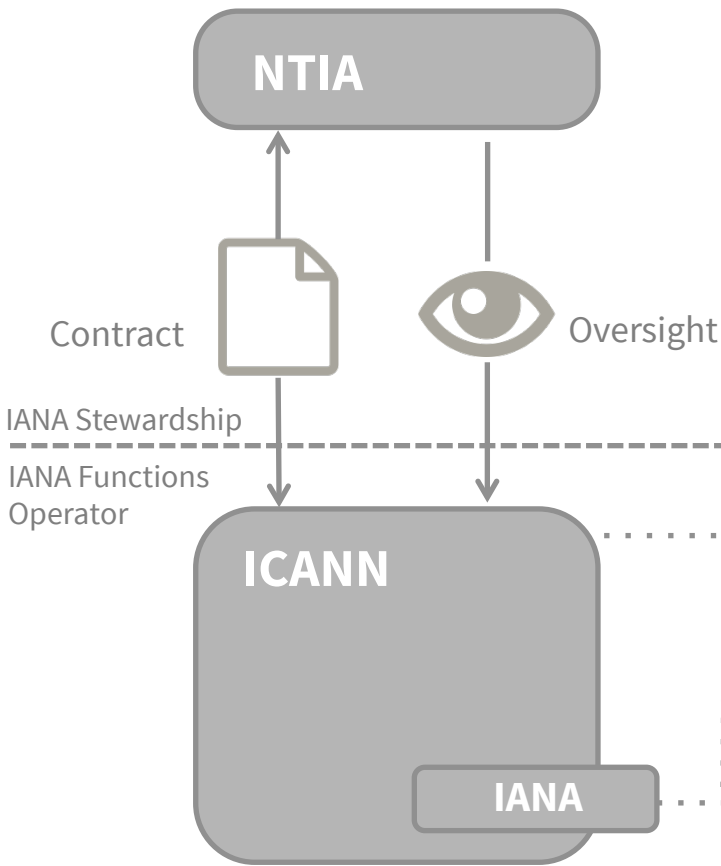

## Post Transition

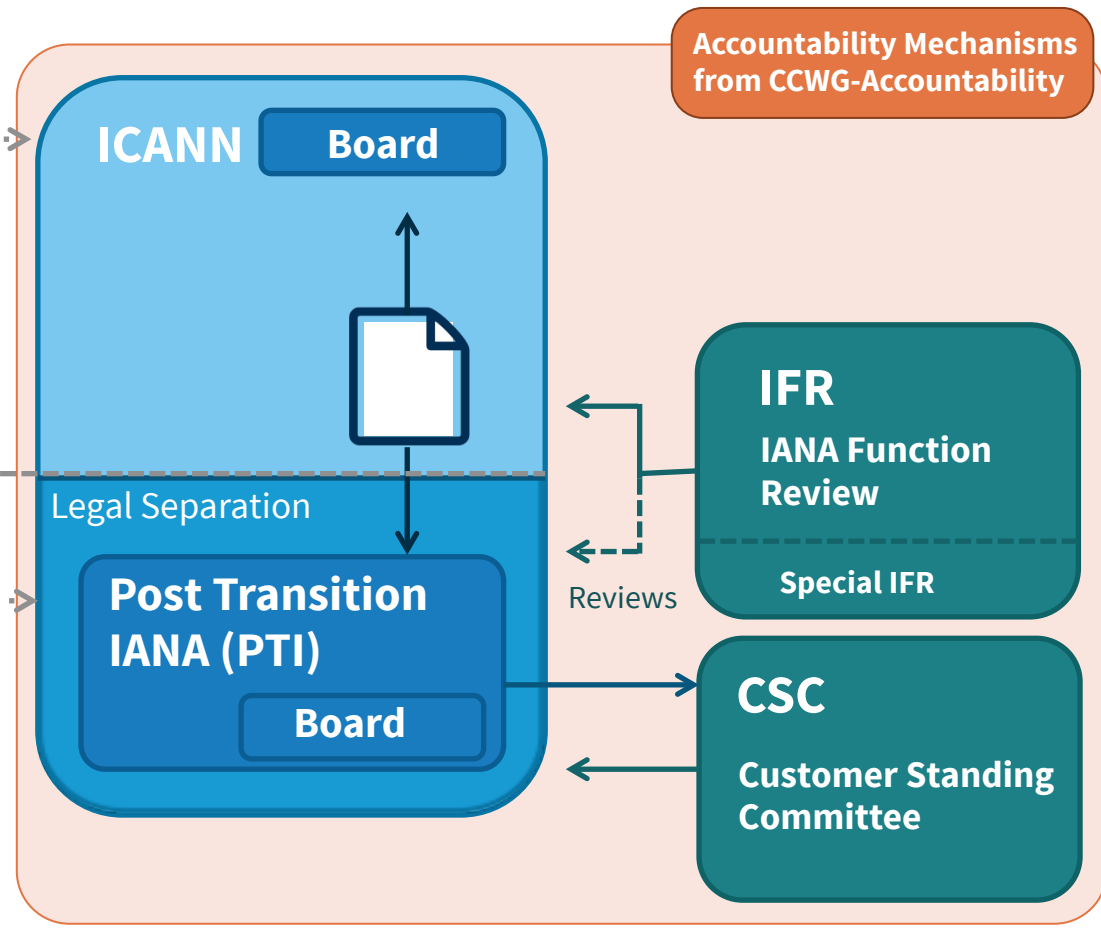

# Post Transition IANA (PTI)

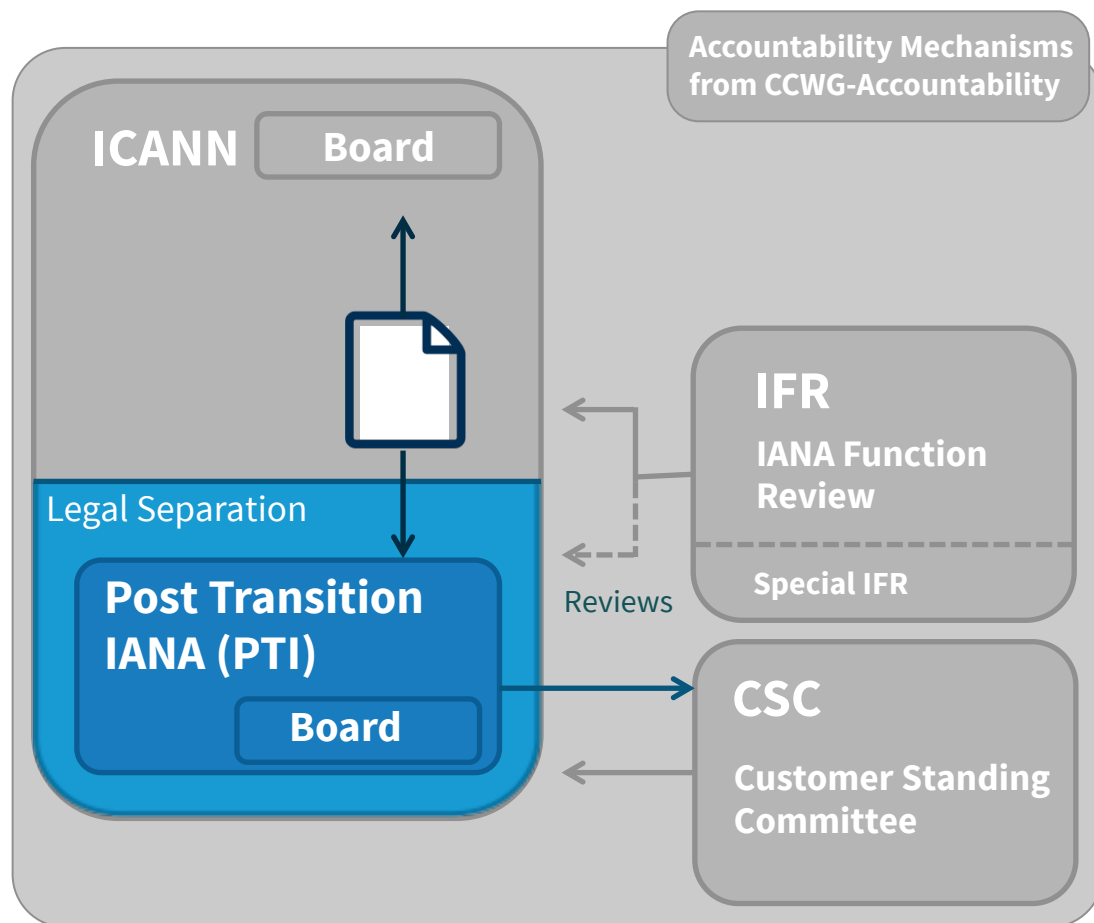

## PTI Composition:

- 1 - ICANN Executive responsible for PTI
- 1 - The ICANN CTO
- 1 - IANA Managing Director
- 2 - Independent Directors

# Customer Standing Committee (CSC)

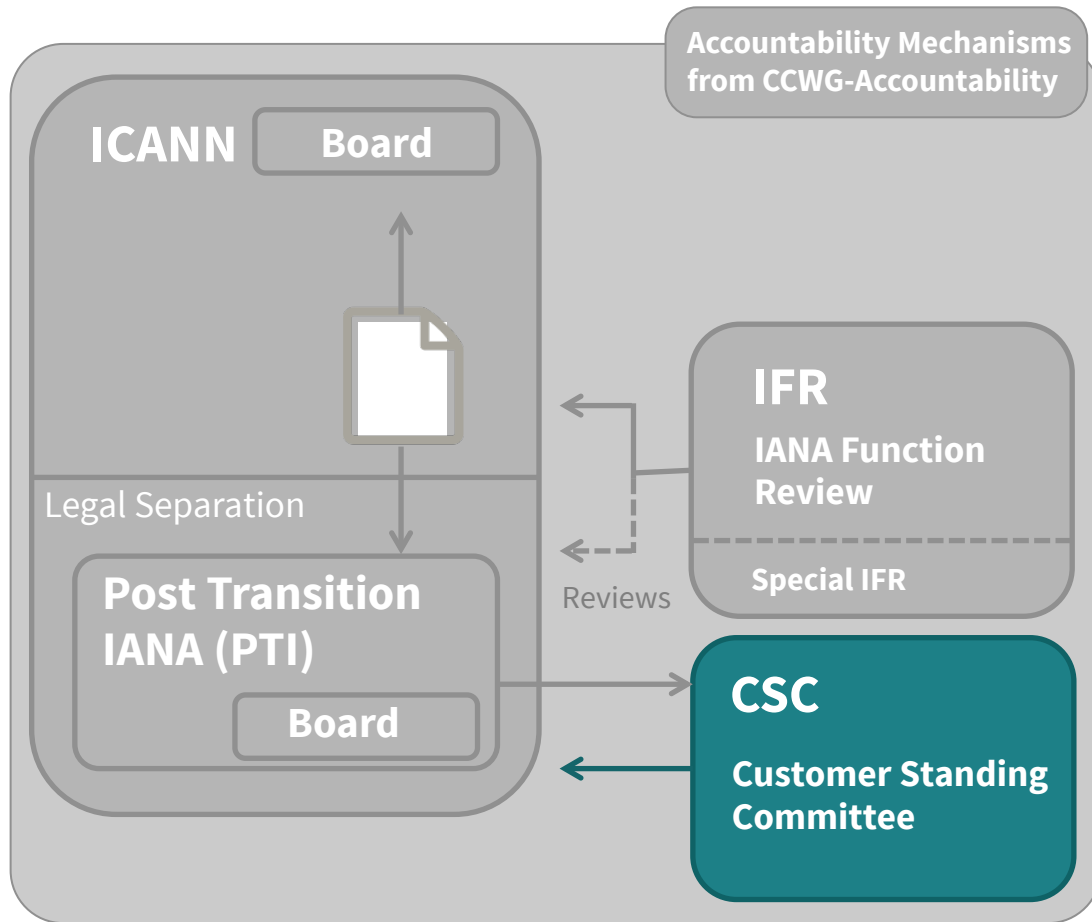

## CSC Composition:

- 2 gTLD registry operators
- 2 ccTLD registry operators
- 1 additional TLD representative (non-gTLD and non-ccTLD)
- 1 Liaison from IANA
- 1 Liaison each from each ICANN Supporting Organization & Advisory Committee (total of 5)



# IANA Function Review (IFR)

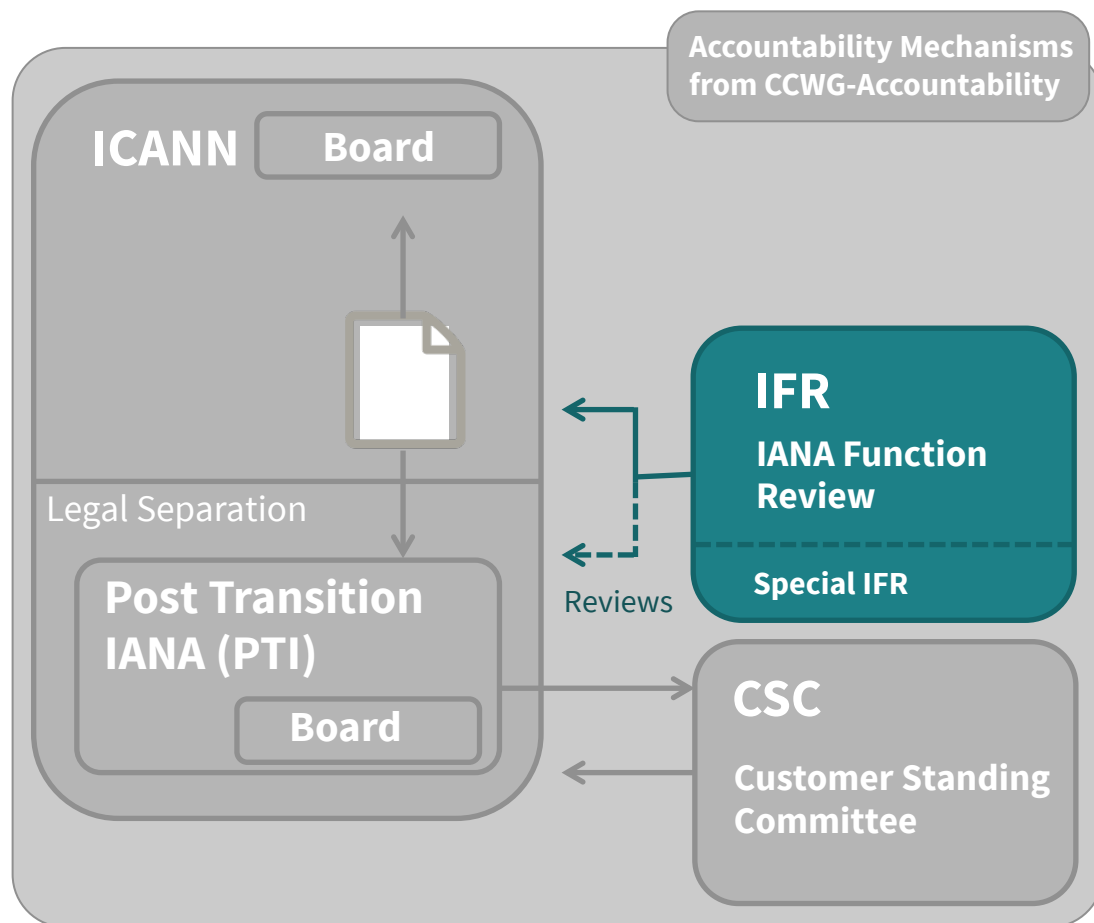

## IFR Composition:

- 2 – ccNSO
- 1 - ccTLDs (non-ccNSO)
- 2 - Registry Stakeholder Group (RySG)
- 1 - Registrar Stakeholder Group (RsSG)
- 1 - Commercial Stakeholder Group (CSG)
- 1 - Government Advisory Committee (GAC)
- 1 - Security and Stability Advisory Committee (SSAC)
- 1 - Root Server Operators Advisory Committee (RSSAC)
- 1 - At-Large Advisory Committee (ALAC)
- 1 - CSC Liaison
- 1 – PTI point of contact (not a member of the IFRT)

A world map where the continents are defined by a complex network of white dots and thin white lines. The dots vary in size, and the lines connect them to form a web-like structure. The background is a solid teal color.

# CCWG-Accountability

# Part of a Process

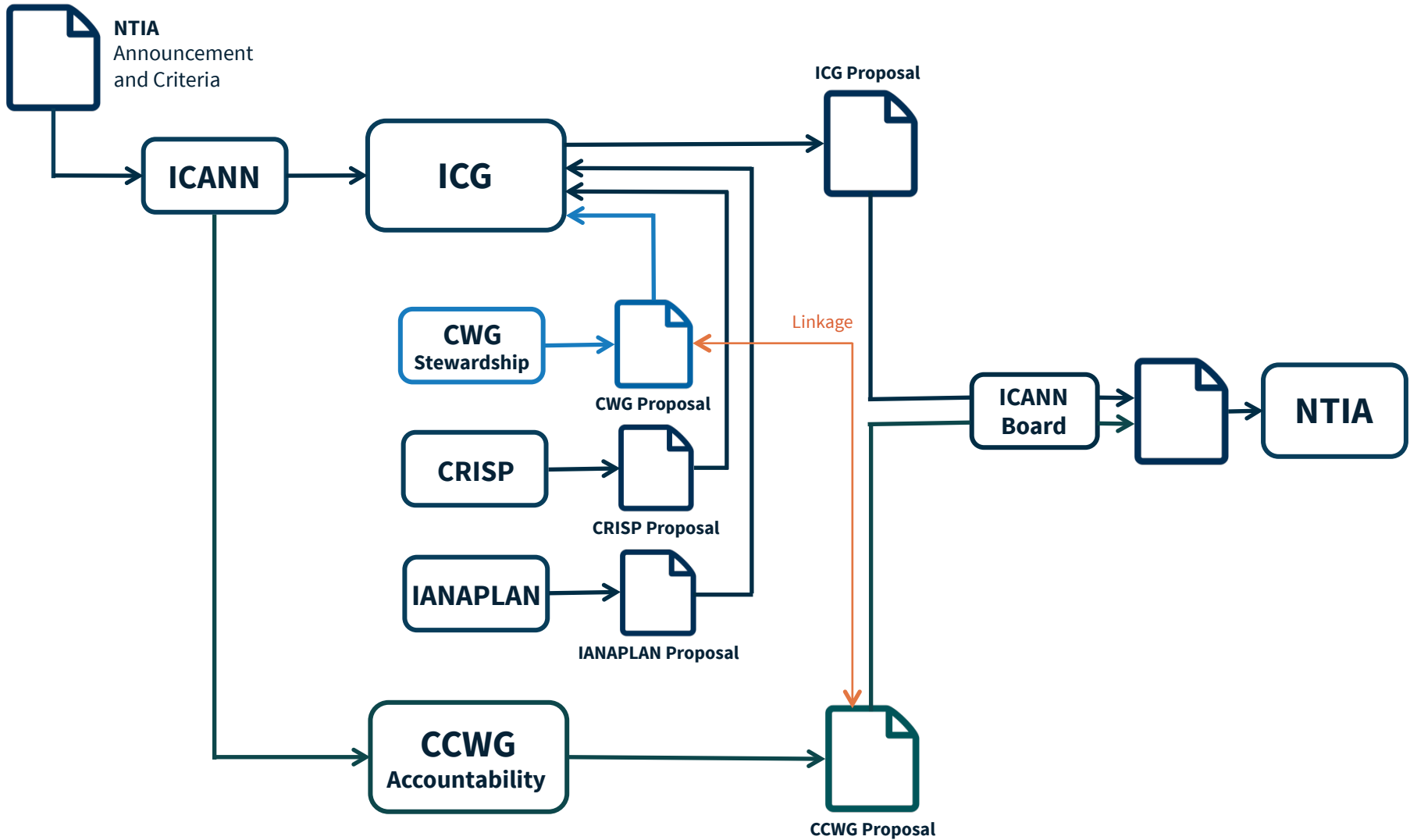

# Goals and Requirements

## Goal:

Deliver proposals that would enhance ICANN's accountability towards all stakeholders.

## The CCWG-Accountability has two Work Streams:



### Work Stream 1

Focused on mechanisms enhancing ICANN-Accountability that must be in place or committed to within the time frame of the IANA Stewardship Transition



### Work Stream 2

Focused on addressing accountability topics for which a timeline for developing solutions and full implementation may extend beyond the IANA Stewardship Transition

# Statistics and Diversity of the CCWG

 **26**  
Members

 **120**  
Participants

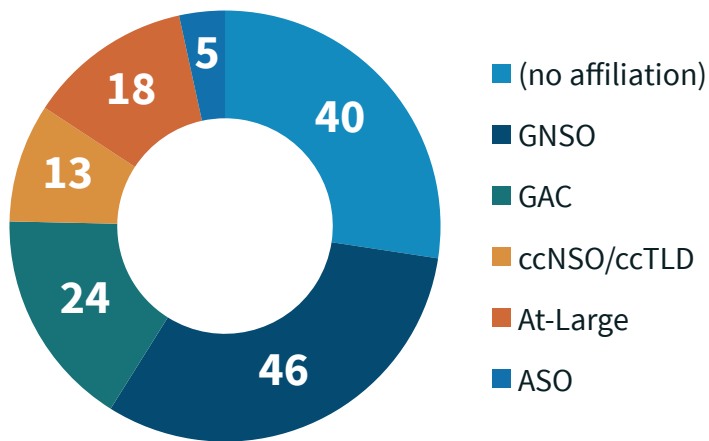

**94**  
Calls/Meetings



**5,504**  
Volunteer Hours



**5,043**  
Mailing List  
Messages



# Building Blocks



## Empowered Community

Refers to the powers that allow the community i.e. the people to take action should ICANN breach the principles



## ICANN Board

Represents the executive entity the community may act against, as appropriate

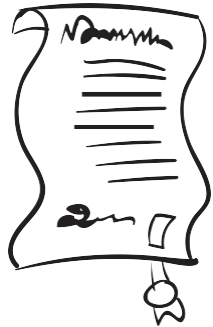

## Principles Form the Mission

Guarantees and core values of the organization i.e the Constitution



## Independent Review Mechanisms

i.e. the judiciary, confers the power to review and provide redress, as needed

# Pre-Transition

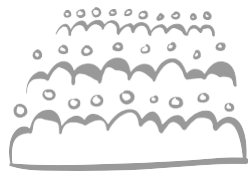

**Community**

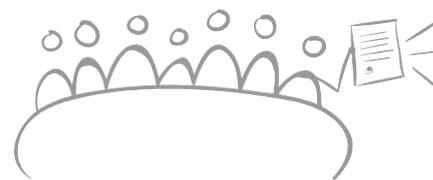

**BUDGET**  
**STRAT/OPS PLANS**  
**BYLAWS**

**Board**

**Principles**



**Independent  
Appeals  
Mechanism**



**IRP**

# Post-Transition: Empowered Community



## Principles

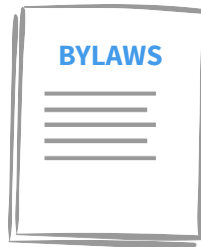

## Independent Appeals Mechanism



# Post-Transition: Community Powers

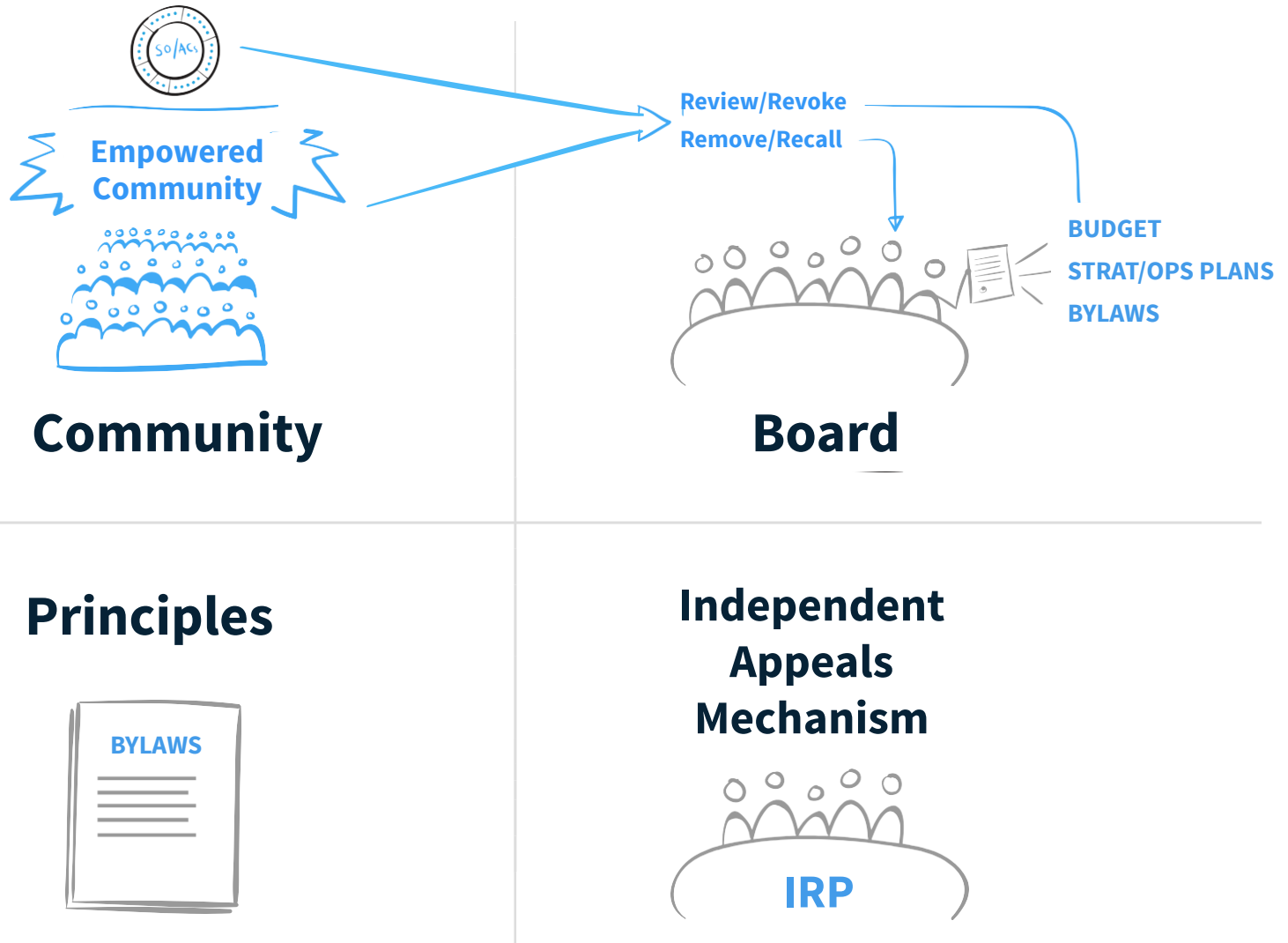

# Post-Transition: Extra Bylaws & Fundamental Bylaws

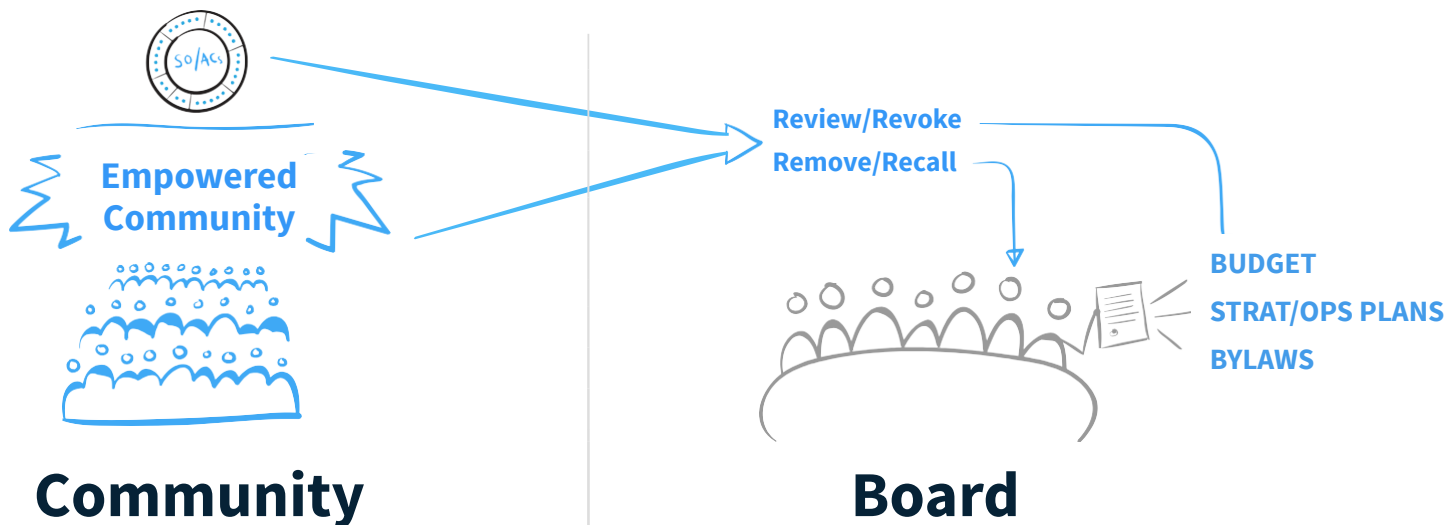

## Principles

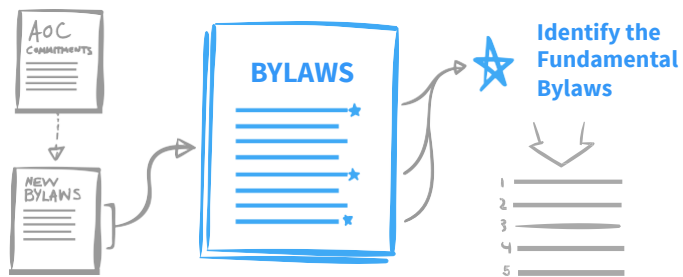

## Independent Appeals Mechanism





# Post-Transition: Enhanced IRP

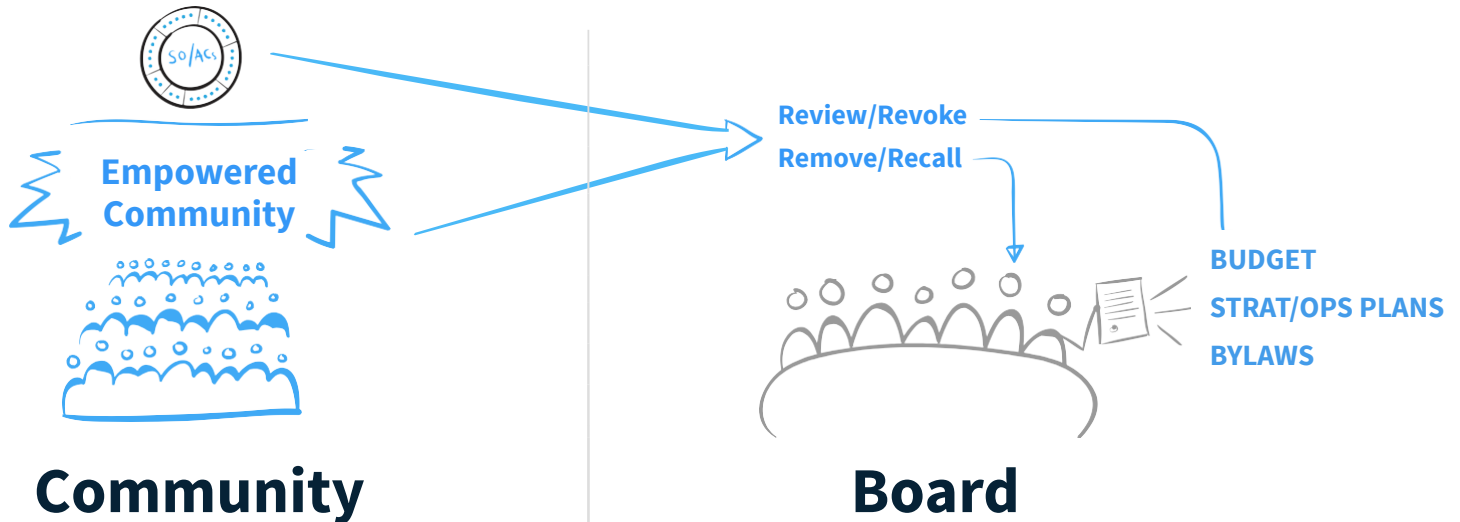

## Principles

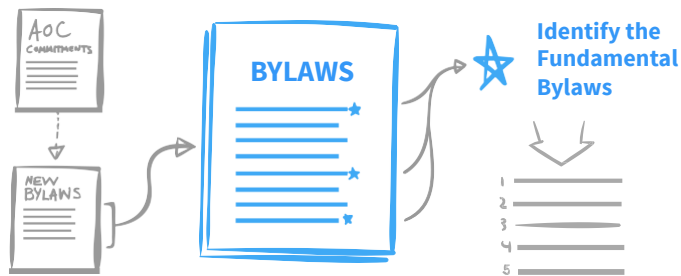

## Independent Appeals Mechanism

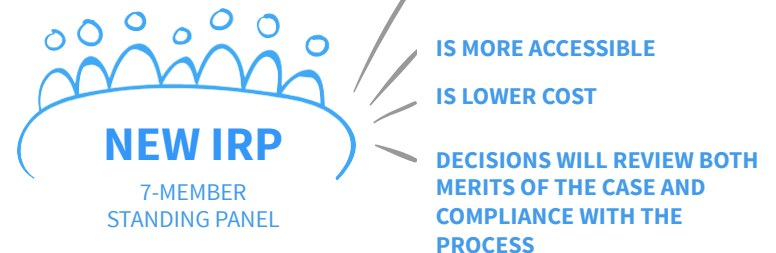

# SO/AC Membership Model

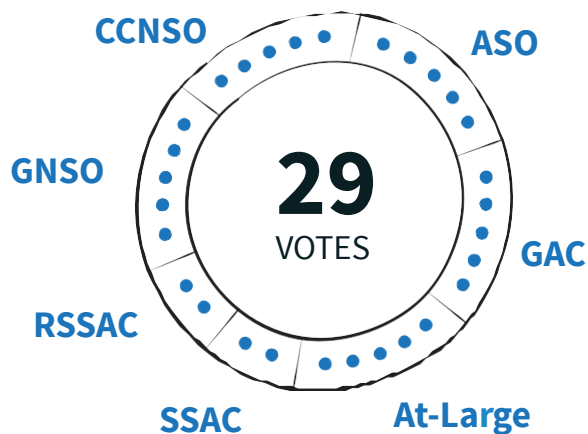
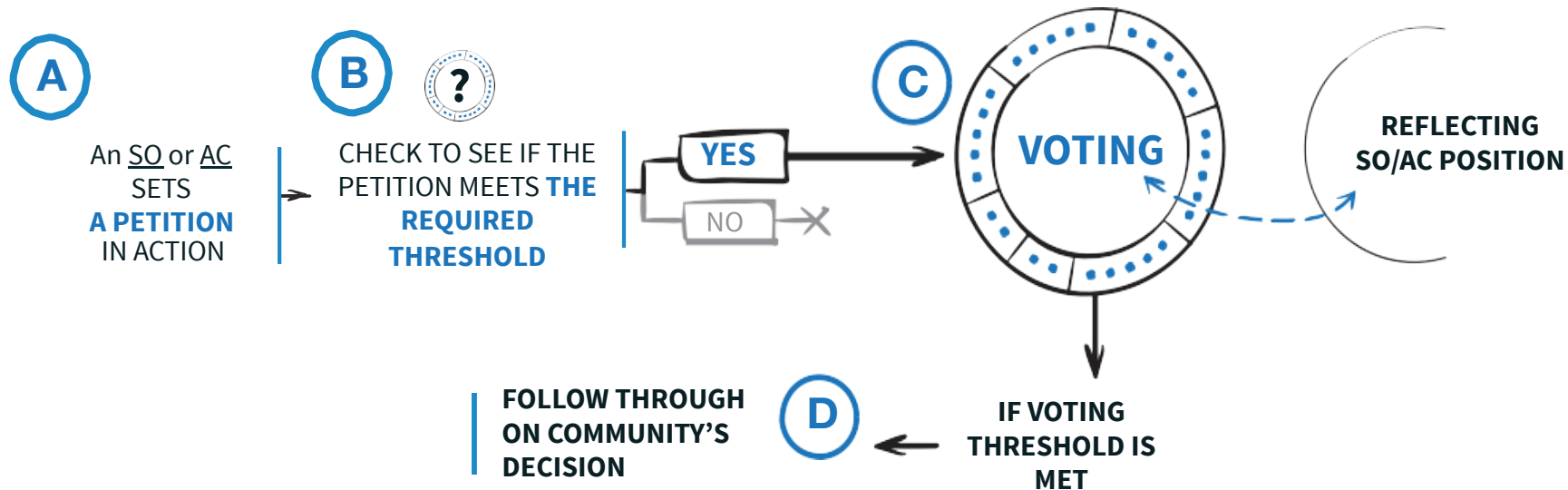

## Influence in the Community Mechanism

Each SO and AC has a number of “votes” in the community mechanism, deciding on the powers established for the community

# Public Comment Review



## Recommendations that received strong support, near consensus

- Overall architecture (4 building blocks)
- Principle of Fundamental Bylaws
- A clearer definition of ICANN's Purpose and Mission
- Incorporation of AoC Reviews into the Bylaws



## Recommendations that require further explanation, clarification

- Independent Review Process (IRP)



## New Issues and Concerns

- Staff and management accountability (corporate culture of accountability)
- Community accountability
- Diversity
- Membership model and legal enforceability

# Linkage & Coordination with CWG-Stewardship

**1**

## **ICANN Budget**

Community rights regarding development and consideration

**4**

## **CSC**

Incorporated into the bylaws

**2**

## **ICANN Board**

Community rights, specifically to appoint/remove members, recall entire Board

**5**

## **Independent Review Panel**

Should be made applicable to IANA Functions and accessible by TLD managers

**3**

## **IANA Function Review**

Incorporated into the bylaws

**6**

## **Fundamental bylaws**

All foregoing mechanisms are to be provided for in the bylaws as “fundamental bylaws”

**The CWG-Stewardship’s proposal is expressly conditioned upon the outcomes of the CCWG-Accountability.**

A world map where the continents are defined by a complex network of white nodes and connecting lines, set against a dark blue background. The nodes vary in size, and the lines represent connections between them, creating a digital or network-like appearance of the globe.

# Townhall Discussion



# Post-Transition Structure

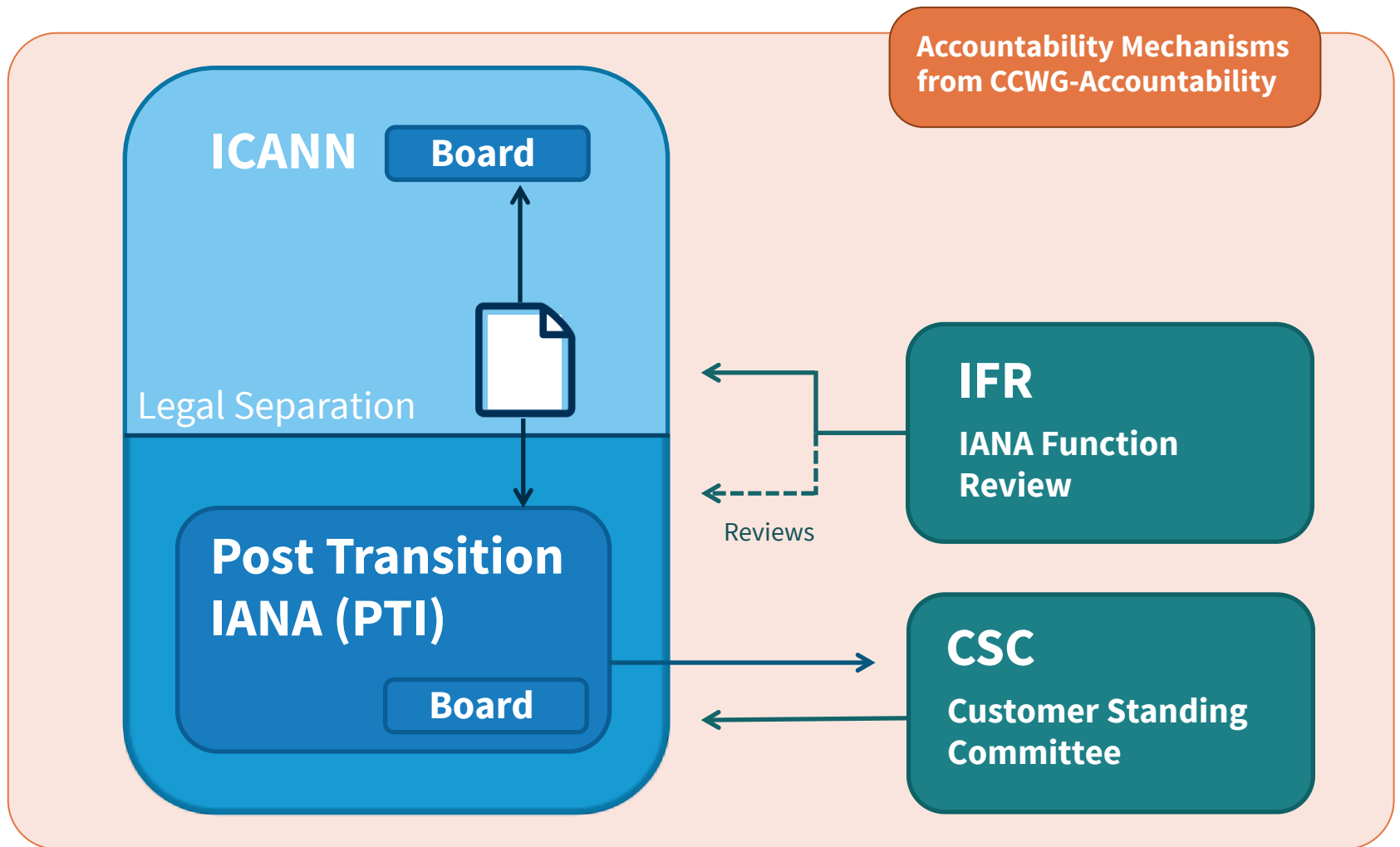

# Linkage & Coordination with CCWG-Accountability

**1**

## **ICANN Budget**

Community rights regarding development and consideration

**4**

## **CSC**

Incorporated into the bylaws

**2**

## **ICANN Board**

Community rights, specifically to appoint/remove members, recall entire Board

**5**

## **Independent Review Panel**

Should be made applicable to IANA Functions and accessible by TLD managers

**3**

## **IANA Function Review**

Incorporated into the bylaws

**6**

## **Fundamental bylaws**

All foregoing mechanisms are to be provided for in the bylaws as “fundamental bylaws”

**The CWG-Stewardship’s proposal is expressly conditioned upon the outcomes of the CCWG-Accountability.**