

CWG-Stewardship

Cross Community Working Group to Develop an IANA Stewardship Transition Proposal on Naming Related Functions

Towards a Final Proposal

June 10, 2015 • v4.0

CWG-Stewardship: **Statistics & Diversity**

June 10, 2015 • v4.0

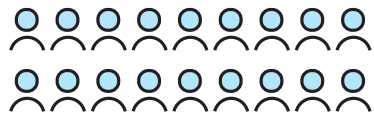

19

Members

133

Participants

Of the 153 CWG members and participants, the regional representation is as follows:

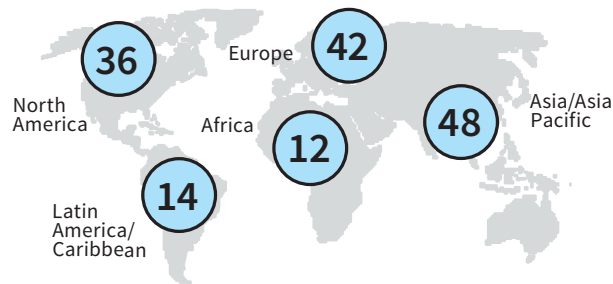

Of the 153 CWG members and participants, the stakeholder group representation is as follows:

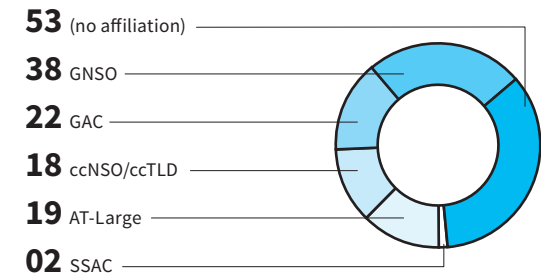

94

Calls/Meetings



4,688

Volunteer Hours



3,922

Total Mailing List Messages



35

Average Number of Attendees per Plenary Call

CWG-Stewardship: Part of a Process

June 10, 2015 • v4.0

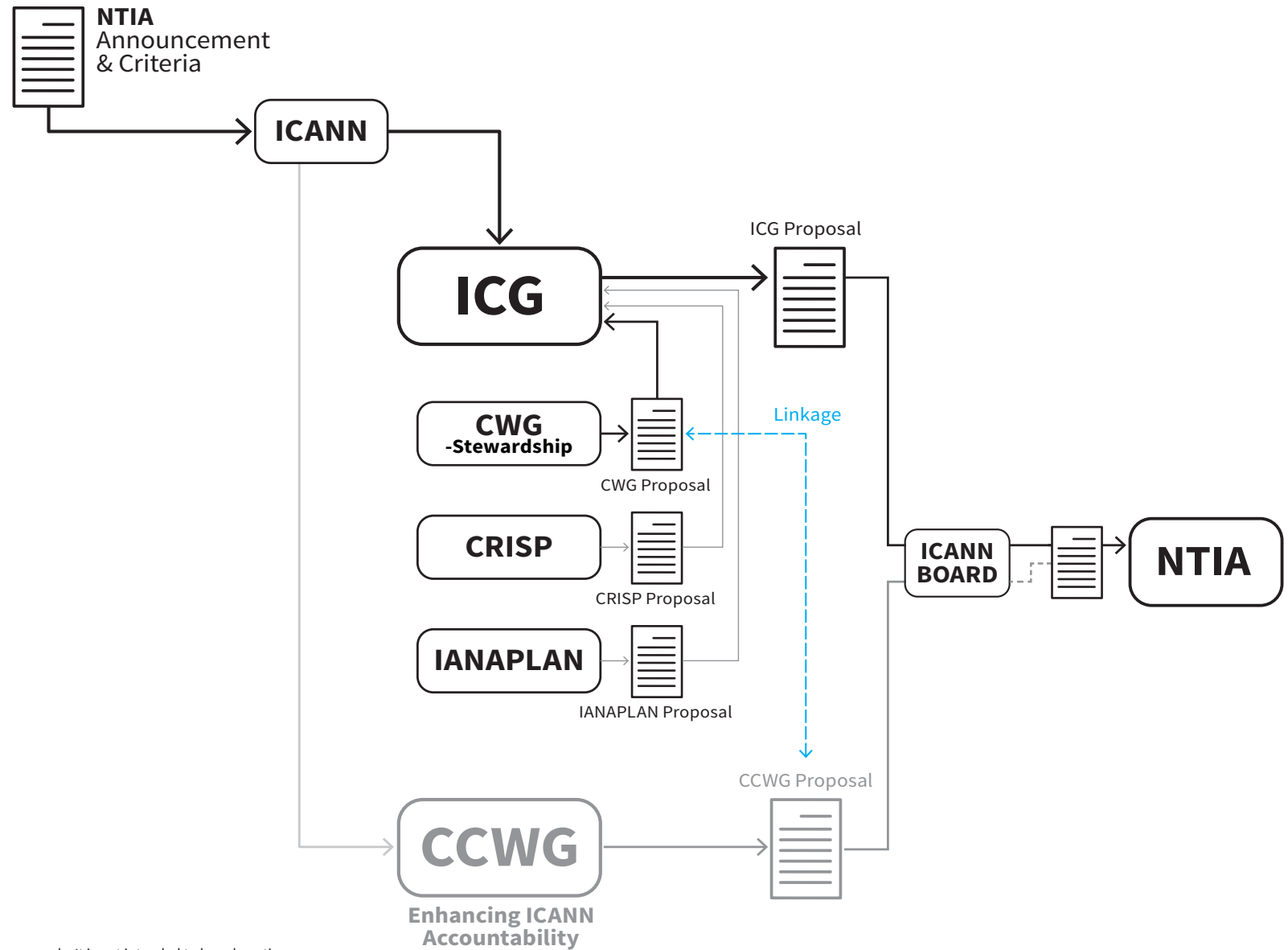

Note: the information on this page is for illustrative purposes only. It is not intended to be exhaustive.

CWG-Stewardship: Goals, Scope, and Requirements

June 10, 2015 • v4.0

The Goal of CWG-Stewardship

Produce a consolidated transition proposal for the elements of the IANA Functions relating to the Domain Name System.

The proposal must meet the needs of:

- The naming community in general
- All of the CWG-Stewardship's chartering organizations (ccNSO, SSAC, GNSO, ALAC, GAC)
- Direct consumers of IANA naming services including gTLDs and ccTLDs

Scope

The CWG-Stewardship is focused on 2-9 and 11 of the NTIA's list of IANA Functions found here: <https://community.icann.org/display/gnsocwgdtdstwrdsdp/Charter>

Requirements

The CWG-Stewardship, working on the premise that there is current satisfaction with ICANN's IANA department performance, and that ICANN should remain the IANA Functions Operator, agreed that a transition proposal for the names community would require the following elements:



A contract similar to the current IANA Functions contract



Accountability mechanisms on ICANN with respect to IANA operations



Additional insulation between operational and policymaking responsibilities and protections for the IANA Functions Operator



A mechanism to approve changes to the Root Zone environment



The ability to ensure adequate funding of the IANA Functions by ICANN



The ability for the multistakeholder community to require the selection of a new operator for the IANA Functions, if necessary.

CWG-Stewardship: Initial Progress

June 10, 2015 • v4.0

Note: the information on this page is for illustrative purposes only. It is not intended to be exhaustive.

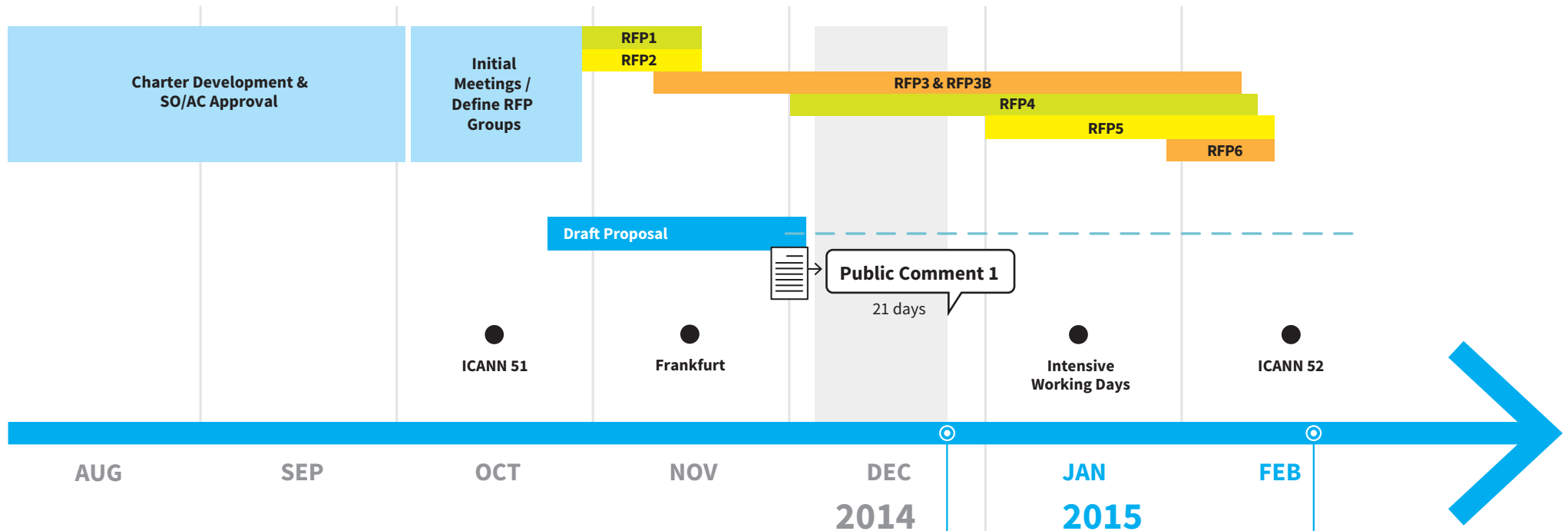

Public Comment 1 Key Takeaways

- Satisfied with IANA services
- Preferred ICANN to retain IANA operations
- Required expert legal advice on structure
- Needed assurances on accountability
- Had both too much and too little detail

ICANN52 - Singapore

- Entered with four structural models, and left with seven
- Highlighted lack of operational specifics
- Did not yet have legal counsel in place
- Established agile new working methods
 - Disbanded RFP groups → Created DTs
 - Increased pace → two plenary meetings per week

CWG-Stewardship: Proposal Development Overview

June 10, 2015 • v4.0

Note: the information on this page is for illustrative purposes only. It is not intended to be exhaustive.

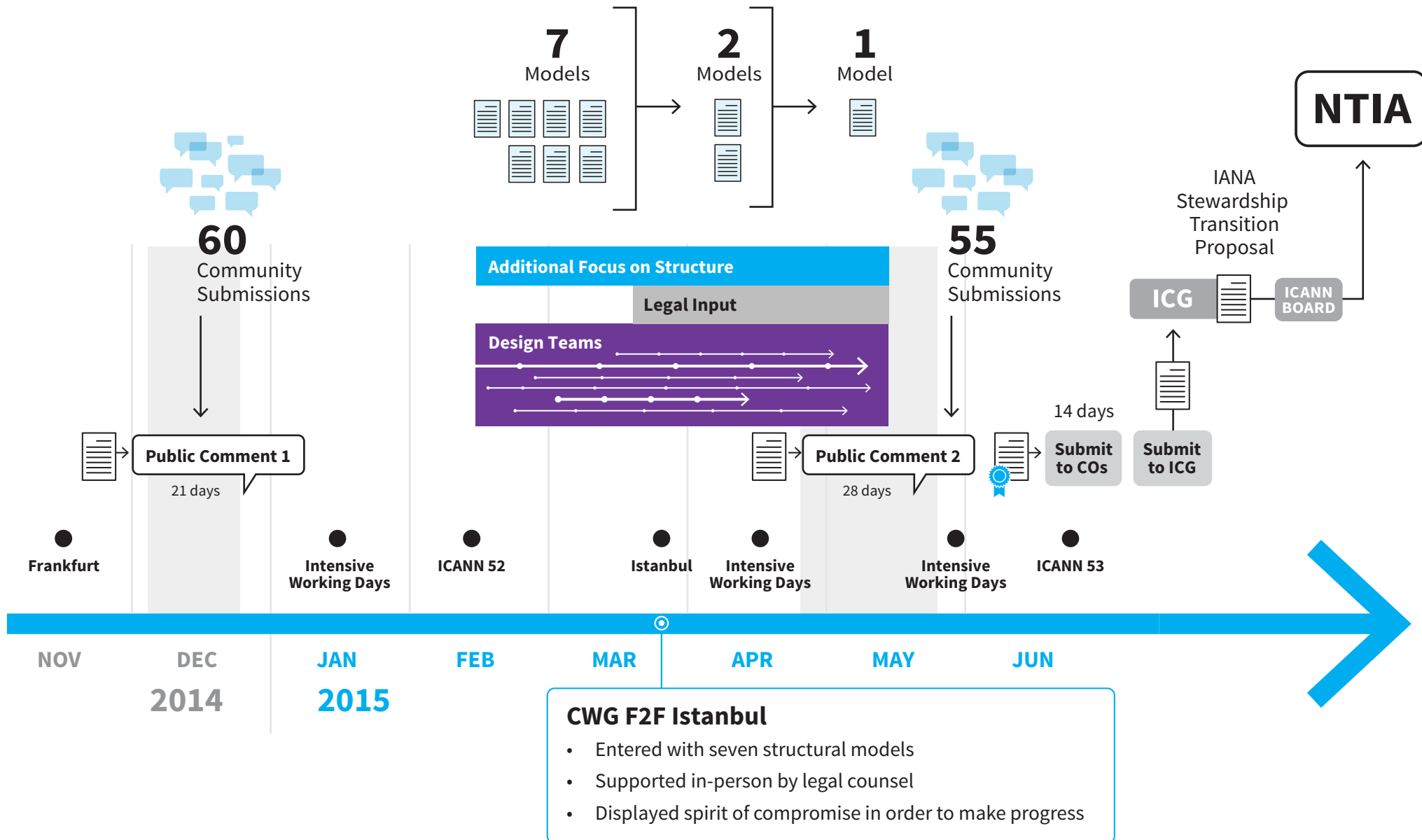

CWG-Stewardship: Linkage & Coordination with the CCWG-Accountability

June 10, 2015 • v4.0

The CWG-Stewardship's proposal has dependencies on, and is expressly conditioned upon, the outcomes of the CCWG-Accountability's work to enhance ICANN's accountability. Specifically, the proposal requires ICANN accountability in the following respects:

Community rights regarding the development and consideration of the ICANN budget	Community rights regarding the ICANN Board , specifically, the ability to appoint and remove members, and to recall the entire Board	The IANA Function Review incorporated into the ICANN bylaws	The Independent Review Panel should be made applicable to IANA Functions and accessible by TLD managers	All of the foregoing mechanisms are to be provided for in the ICANN bylaws as " fundamental bylaws "
		The CSC incorporated into the ICANN bylaws		

The conditionality empowers the community to vote on the CWG-Stewardship proposal in June 2015, and retain significant influence through review of the CCWG-Accountability work later in the year, through October 2015.

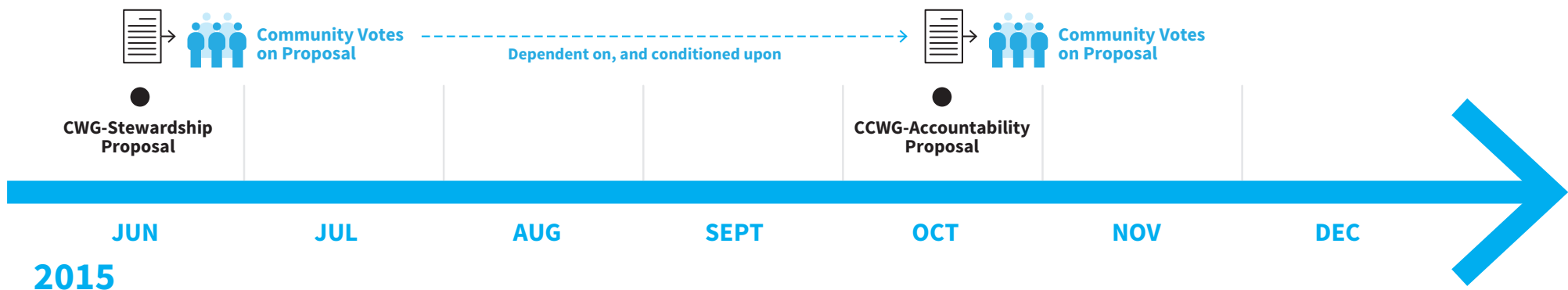

CWG-Stewardship: Internal Accountability Model

June 10, 2015 • v4.0

Current Contract

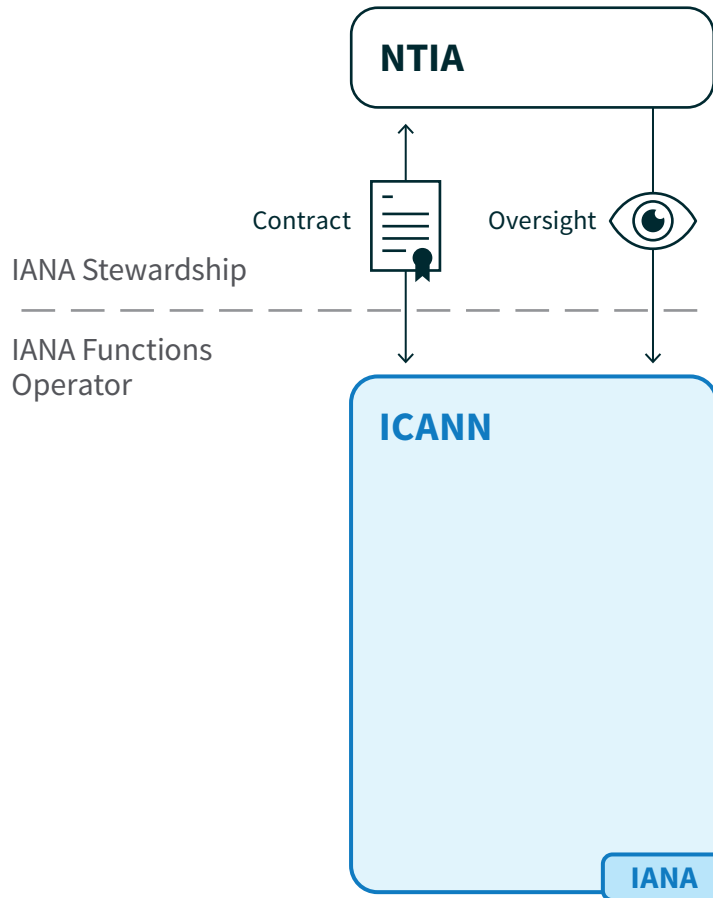

Post Transition

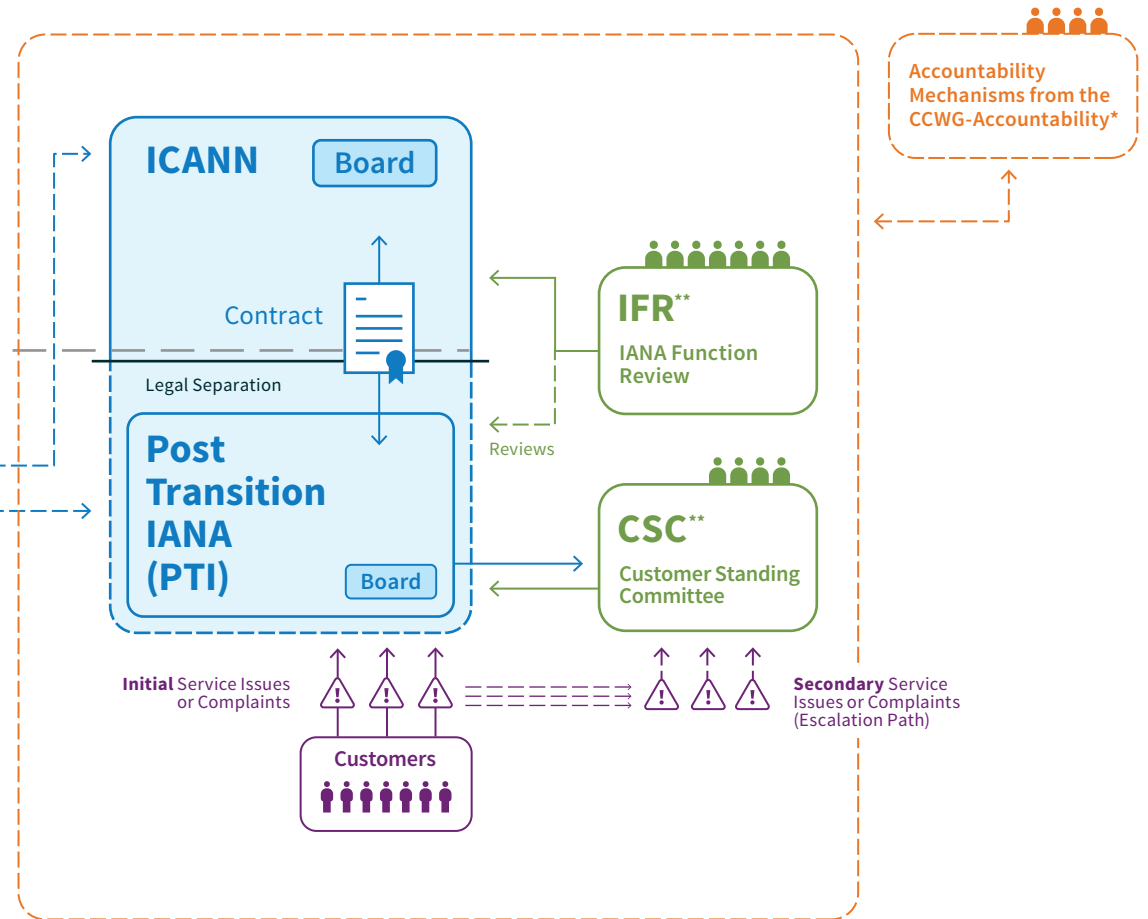

* The ultimate accountability mechanism is dependent on the work of the CCWG-Accountability.

** Group, But Not Necessarily a Legal Entity

CWG-Stewardship: Independent Legal Input

June 10, 2015 • v4.0

In considering a post-transition model the CWG-Stewardship received detailed legal input including examining multiple legal structures for the Post-Transition IANA.

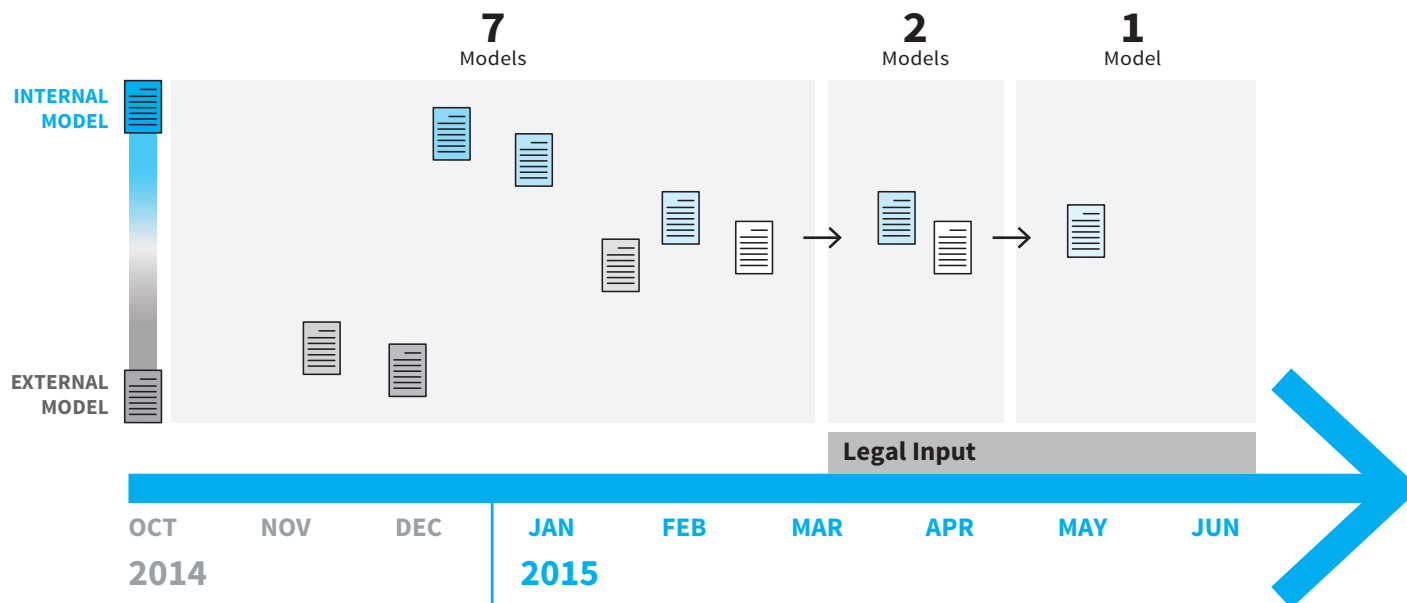

Motivation & Purpose of Legally Separated Entity

- Enhanced structural separation (policy & operational)
- Contracting entity
- Safeguard against ICANN bankruptcy
- Ultimately separable

In addition to the PTI entity, the CWG-Stewardship developed a surrounding accountability framework with the CSC and IFR. The CWG-Stewardship’s proposed structure will also benefit from the CCWG-Accountability’s proposed enhancements to ICANN.

Significant Legal Input Delivered

- Input on proposal
- Structural Model – 20 April
- CSC Governance / Best Practices – 21 April
- CWG Proposal Comments – 21 April
- CCWG Proposal (CWG Considerations / Conditionality) – 30 April
- Legal Structure Summary – 18 April (Revised 3 May)
- Punch List - 12 April (29 April, 1 May, 7 May)
- PTI Board Duties & Costs – 7 May
- PBC vs LLC Table – 7 May
- PTI Board “Stress Tests” – 13 May 2015
- PTI Structure for PTI PBC v LLC – 13 May 2015
- Public Comment 2 – 22 April-20 May 2015
- Draft term sheet – 18 May 2015
- Separation Process Comments – 22 May
- CWG Proposal Comments – 4 - 7 June

CWG-Stewardship: Accountability Details – PTI

June 10, 2015 • v4.0

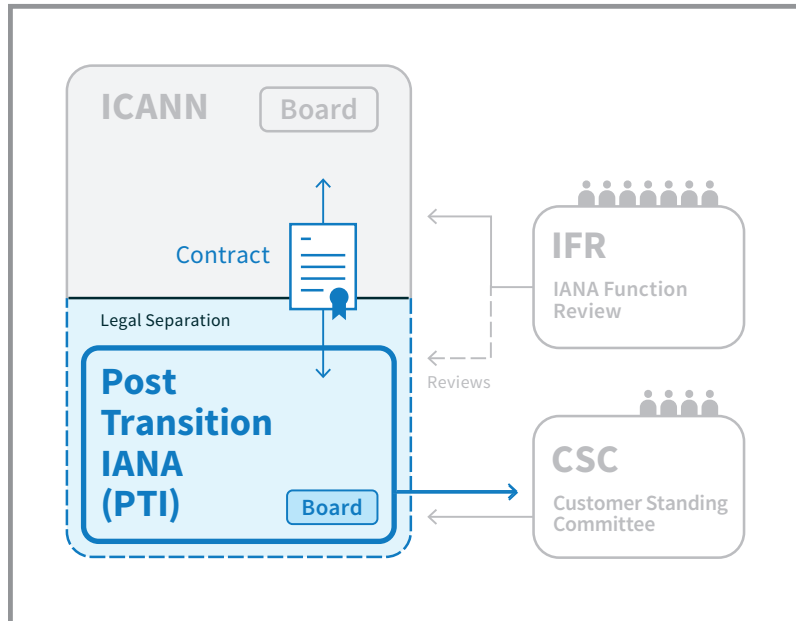

Post-Transition IANA (PTI)

Mission

Established to perform all the existing (pre-transition) IANA functions.

High-Level Scope

- The existing IANA functions department, administrative staff and related resources, processes, data and know-how would be legally transferred to PTI
- PTI would be funded by ICANN and an affiliate of ICANN, but would be a new legal entity that is ringfenced both functionally and legally from ICANN

PTI Board

Exists to:

- Operate the affiliate to meet the statutory requirements for the affiliate, and;
- Performs according to the contract (and the associated SLEs).
- Board Membership:
 - 1 - ICANN Executive responsible for PTI
 - 1 - The ICANN CTO
 - 1 - IANA Managing Director
 - 2 - Independent Directors

CWG-Stewardship: Accountability Details – CSC

June 10, 2015 • v4.0

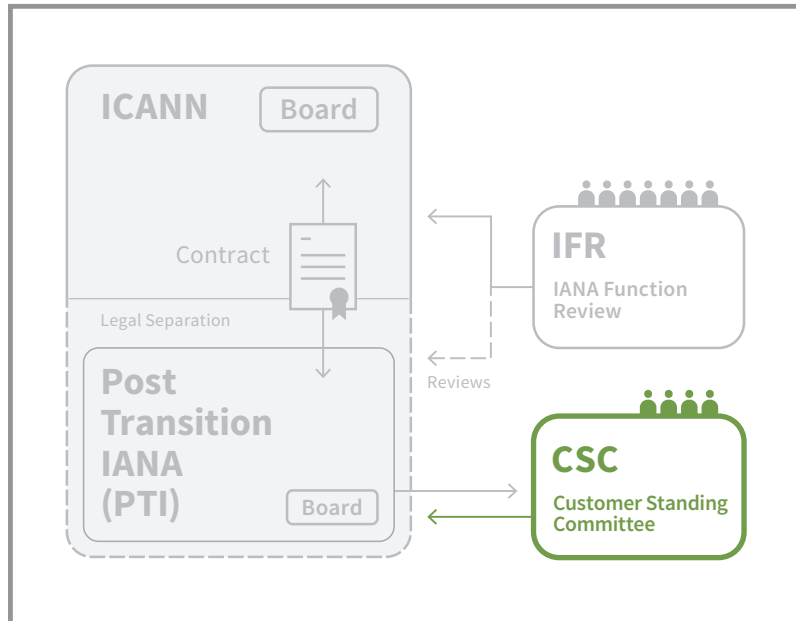

Customer Standing Committee (CSC)

Mission

Established to perform the operational responsibilities previously performed by the U.S. Government, ensure continued satisfactory performance of the IANA naming function.

High-Level Scope

Regular performance monitoring of the IANA naming function against agreed service level targets, and remedial actions to address poor performance on behalf of the Names community – including advice to IANA Functions Operator on improvements.

Membership

Members and Liaisons appointed (or recalled) by their respective communities in accordance with their internal processes. Member terms are two years (with option for two more). A Chair is elected annually by the CSC.

They meet at least one time per month via teleconference (public meeting minutes), and general updates provided publically no fewer than three times per year.

- 2 gTLD registry operators
- 2 ccTLD registry operators
- 1 additional TLD representative (non-gTLD and non-ccTLD)
- 1 Liaison from IANA
- 1 Liaison each from each ICANN Supporting Organization & Advisory Committee (total of 5)

CWG-Stewardship: Accountability Details – IFR

June 10, 2015 • v4.0

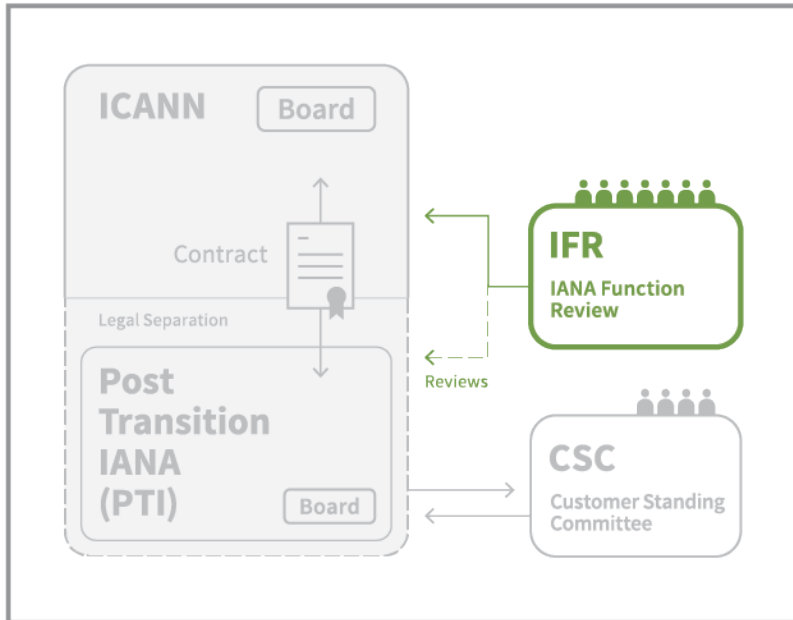

IANA Function Review (IFR)

Mission

Established to provide periodic reviews of PTI's performance to ensure accountability and quality of service.

High-Level Scope

Reviews can include: performance and transparency of IANA functions, effectiveness of structures, and necessary changes or additions

- Reviews should include inputs and records from: the IANA SOW, the CSC, PTI, the Names community, as well as the broader ICANN community
- Review cycles: 1st review to occur no more than 2 years post-transition; then every 5 years. In order to trigger a Special IFR, it would require a vote of both of the ccNSO and GNSO Councils (each by a supermajority vote according to their normal procedures for determining supermajority).
- If deemed necessary, the IFR can recommend separation: this would launch the Separation Cross Community Working Group (SCWG)

Membership

IANA Function Review Team (IFRT) – Team Members and Liaisons will be appointed by their respective communities in accordance with their internal processes.

The IFRT is formed at each review process (it is not a standing team).

- 2 - ccNSO
- 1 - ccTLDs (non-ccNSO)
- 2 - Registry Stakeholder Group (RySG)
- 1 - Registrar Stakeholder Group (RsSG)
- 1 - Commercial Stakeholder Group (CSG)
- 1 - Non-Commercial Stakeholder Group (NCSG)
- 1 - Government Advisory Committee (GAC)
- 1 - Security and Stability Advisory Committee (SSAC)
- 1 - Root Server Operators Advisory Committee (RSSAC)
- 1 - At-Large Advisory Committee (ALAC)
- 1 - CSC Liaison
- 1 - PTI point of contact (not a member of the IFRT)

CWG-Stewardship: Next Steps to Completing Our Process

June 10, 2015 • v4.0

The CWG-Stewardship sends the Proposal to its Chartering Organizations for consideration and approval. The goal is to transmit the Proposal to the ICG by the end of ICANN 53.

