

# IANA Stewardship Transition

A Live Example of a Multistakeholder Process

## WSIS Forum

28 May 2015

# IANA Stewardship Transition: The Big Picture

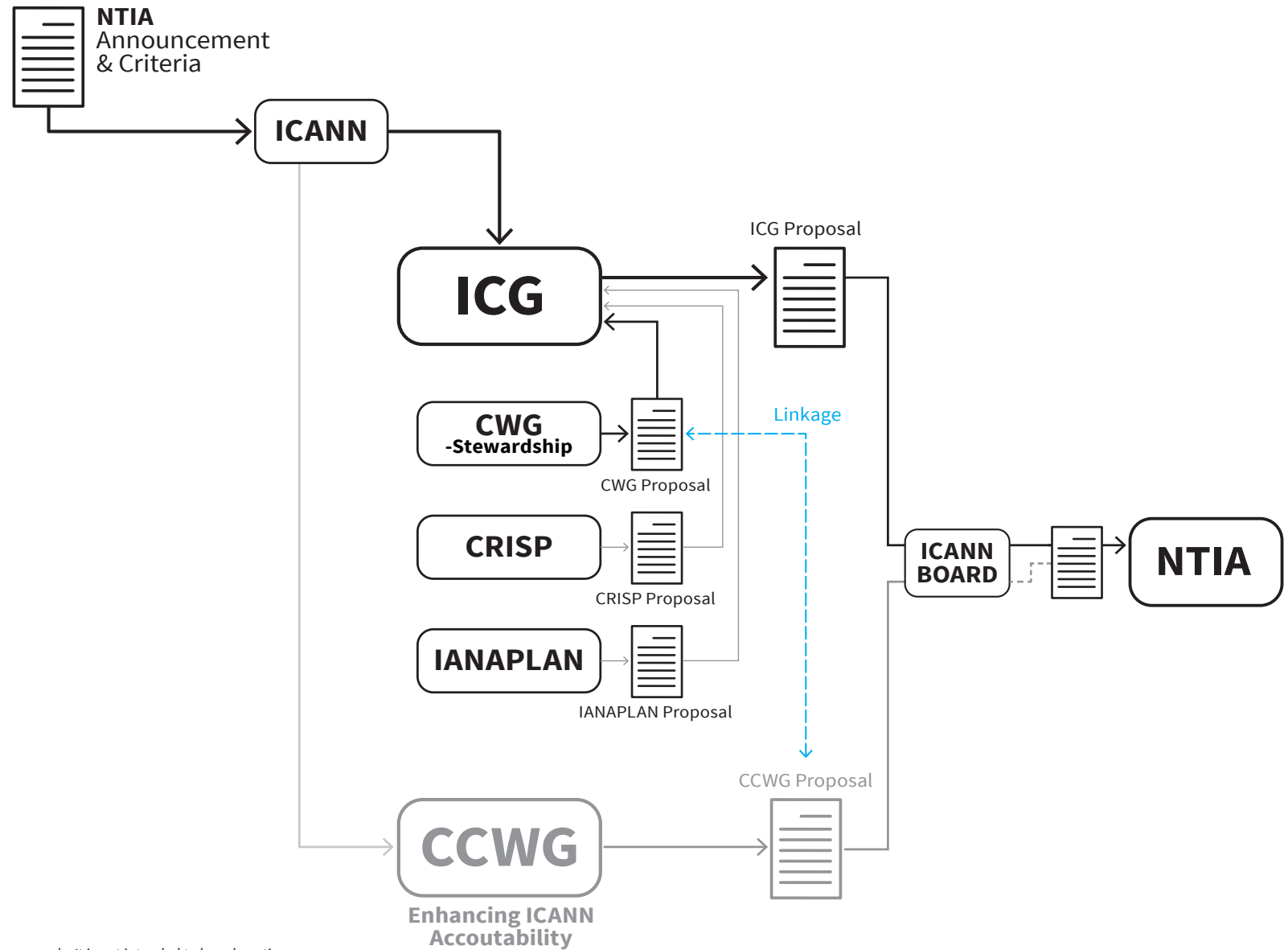

Note: the information on this page is for illustrative purposes only. It is not intended to be exhaustive.

# IANA Stewardship Transition Coordination Group: **Composition**

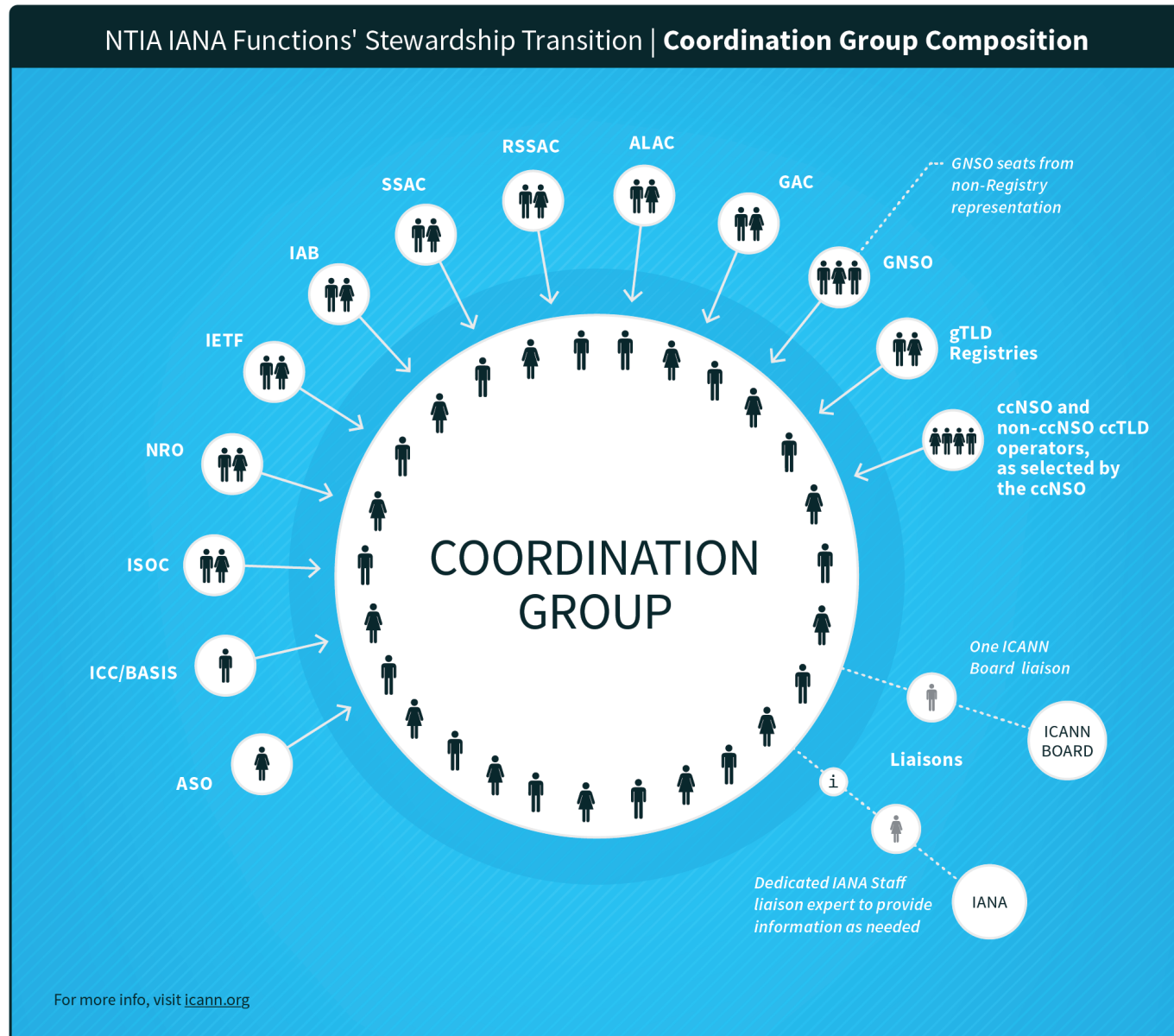

# CWG-Stewardship: Timeline • Progress to Date

Domain Names Community

Note: the information on this page is for illustrative purposes only. It is not intended to be exhaustive.

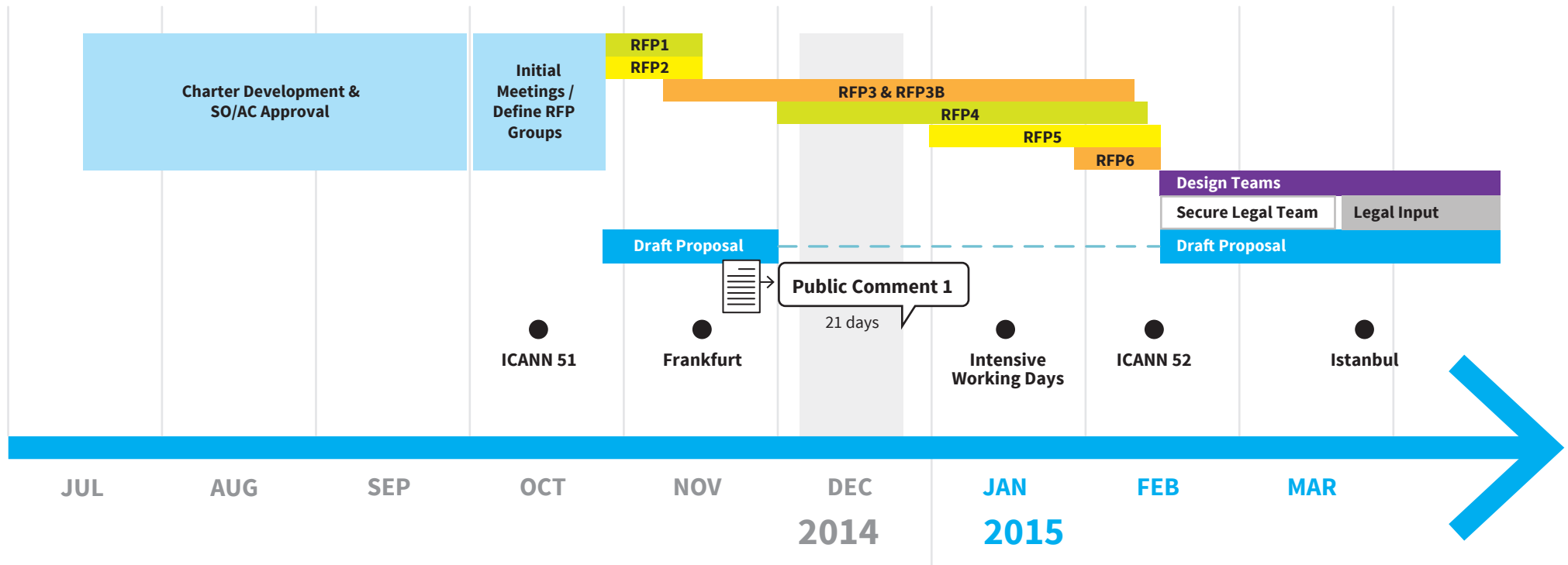
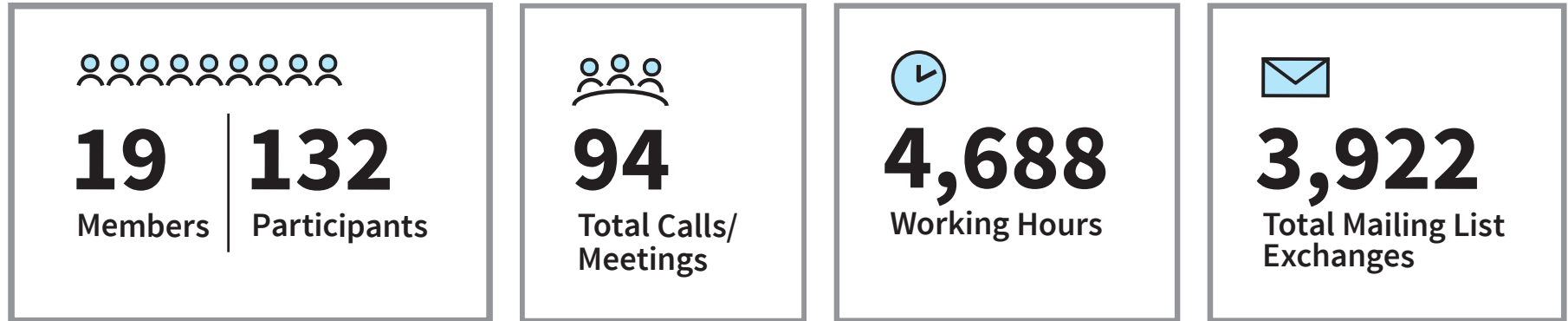

# CWG-Stewardship: Proposal Development Overview

Domain Names Community

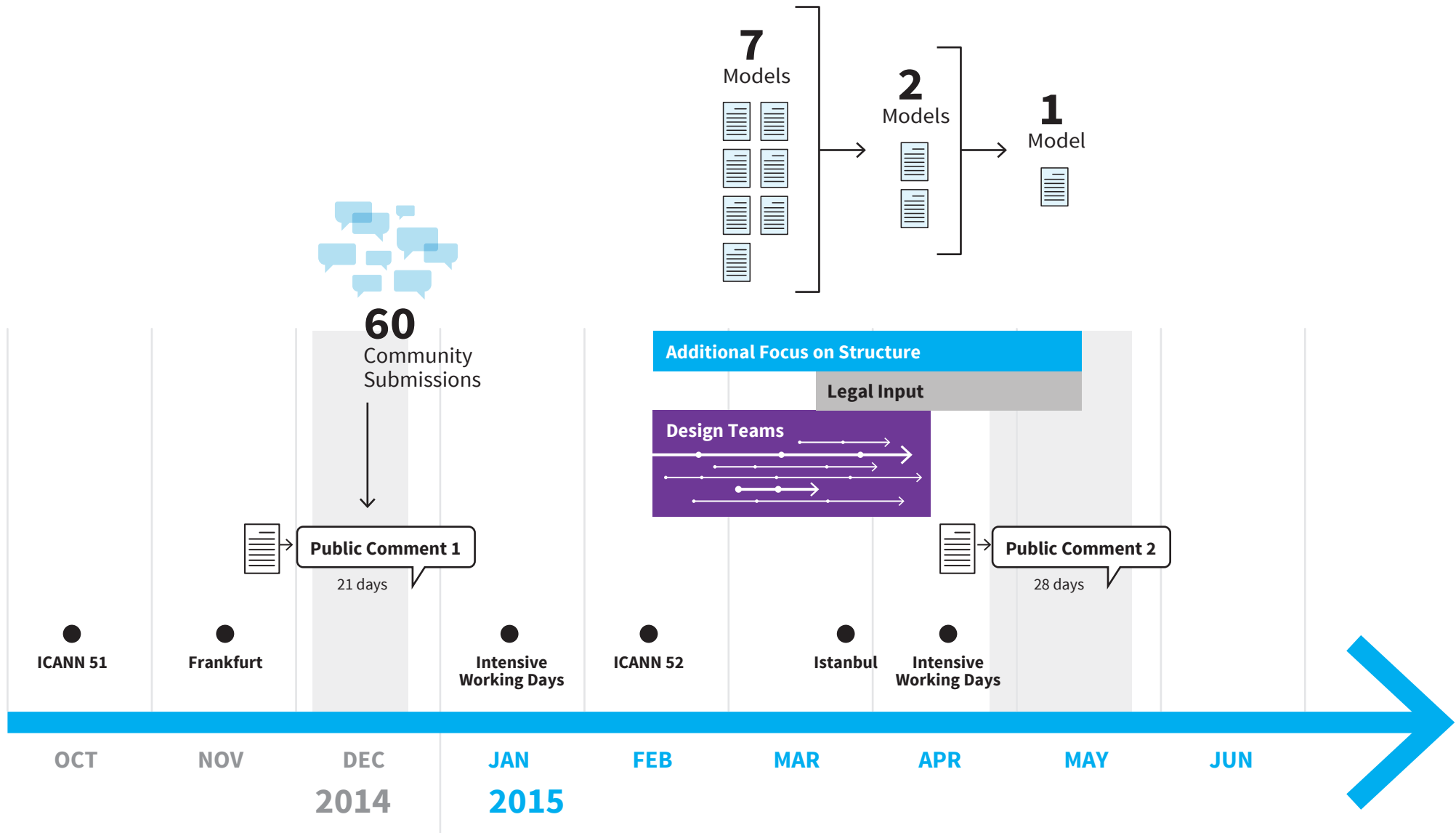

# CWG-Stewardship: Timeline • The Road Ahead

Domain Names Community

Note: the information on this page is for illustrative purposes only. It is not intended to be exhaustive.

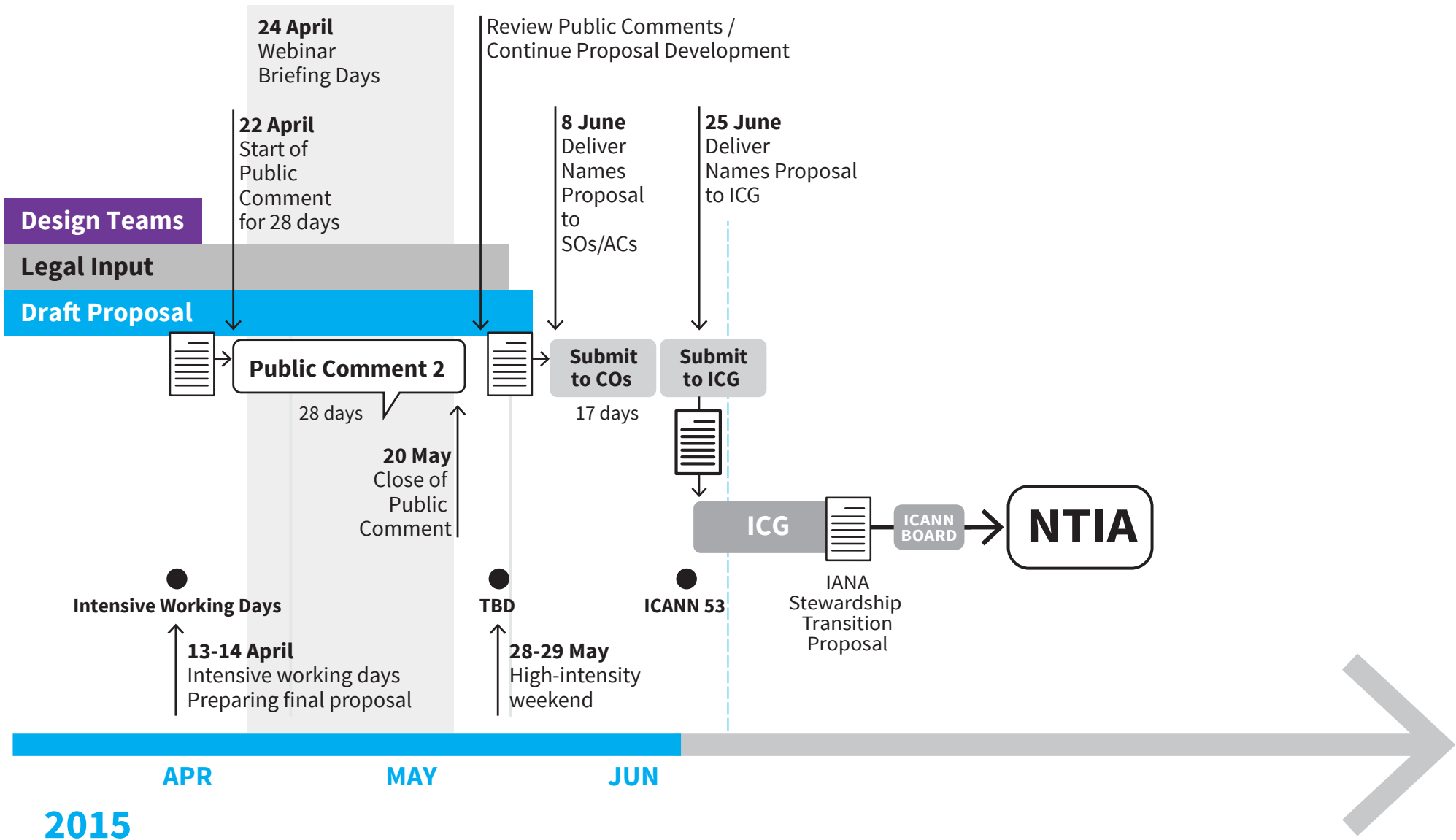

# Enhancing ICANN Accountability: The Big Picture

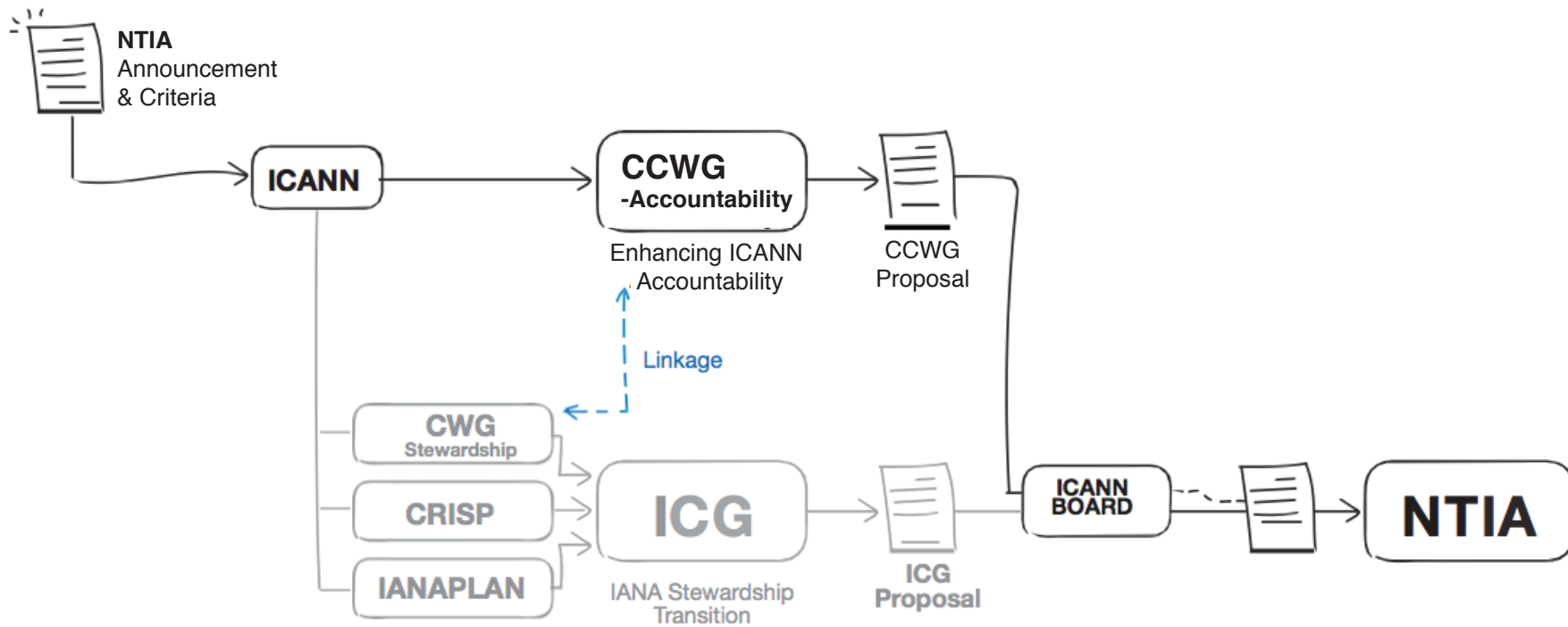

# CCWG-Accountability: Timeline • Progress to Date

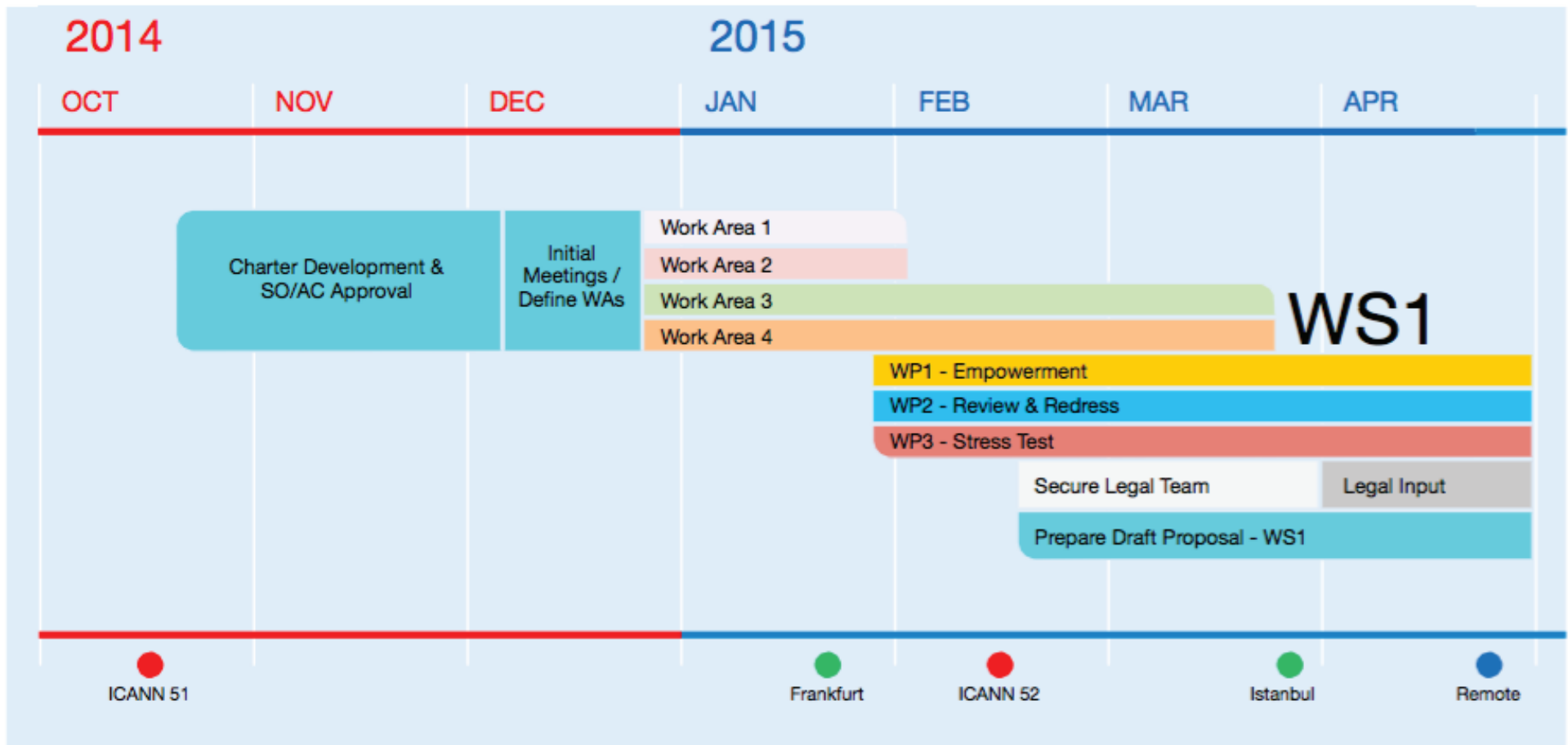
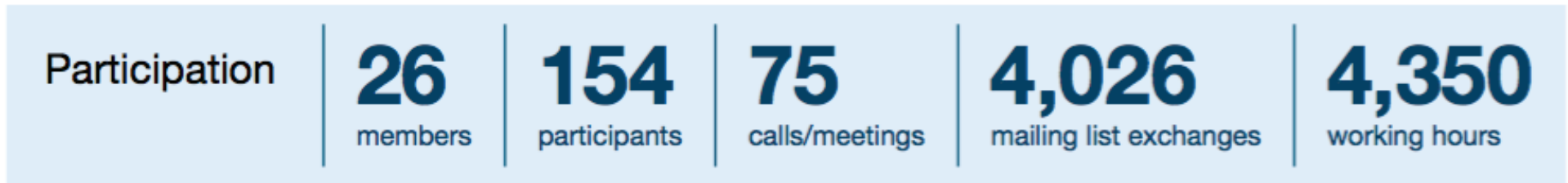



# CCWG-Accountability: Timeline • The Road Ahead

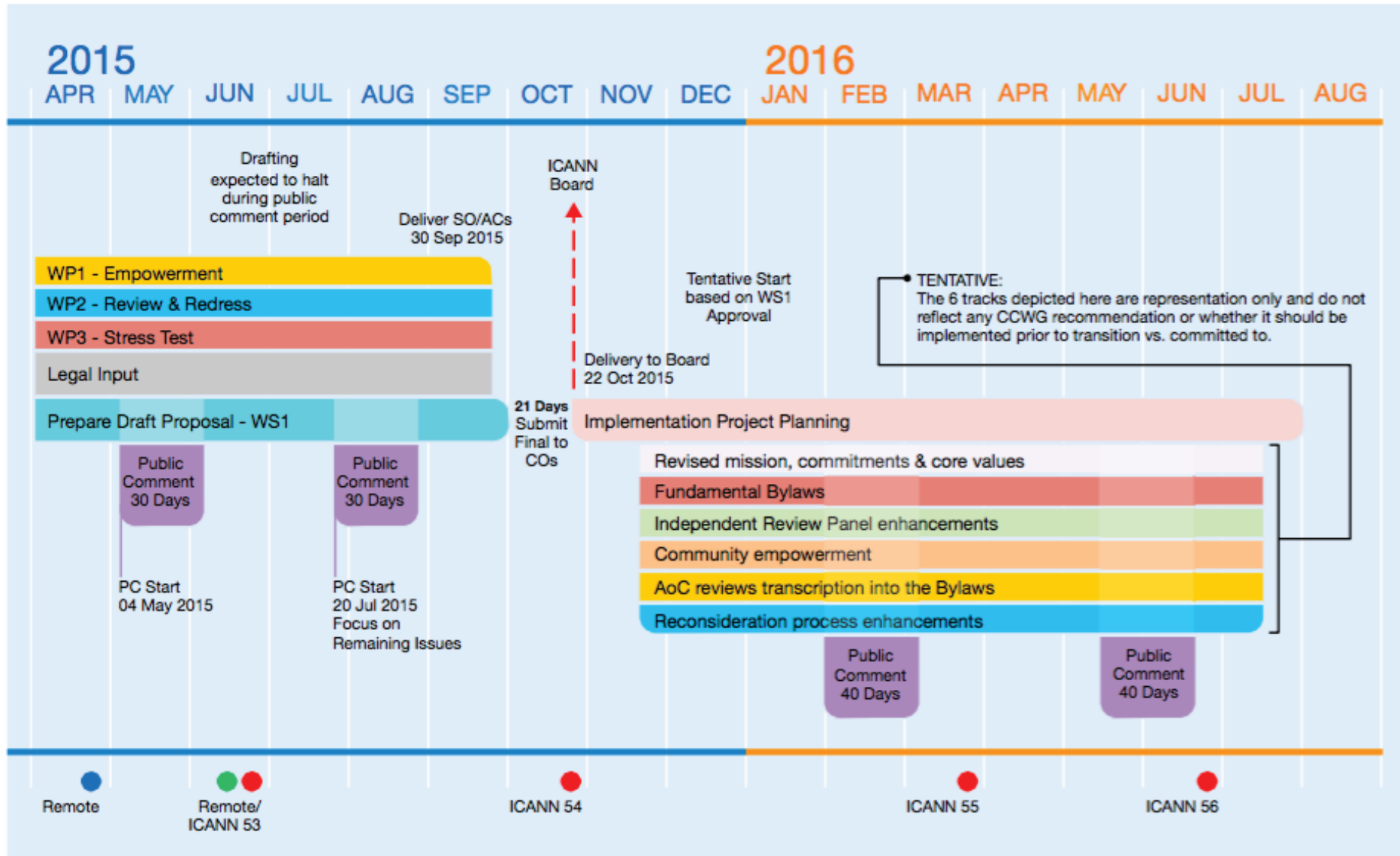

# CRISP Team: **Proposal Development Overview**

Numbering Resources Community

## **June 2014:**

IANA Stewardship Transition Coordination Group (ICG) issues Request for Proposals to three IANA “affected communities.”

## **Q4 2014:**

Consolidated RIR IANA Stewardship Proposal Team (CRISP Team) established to prepare an Internet numbers community proposal.

Global discussion platform established: [ianaxfer@nro.net](mailto:ianaxfer@nro.net)

## **January 2015:**

Internet numbers community IANA stewardship proposal submitted to ICG.

# CRISP Team: Proposal Development Overview

Numbering Resources Community

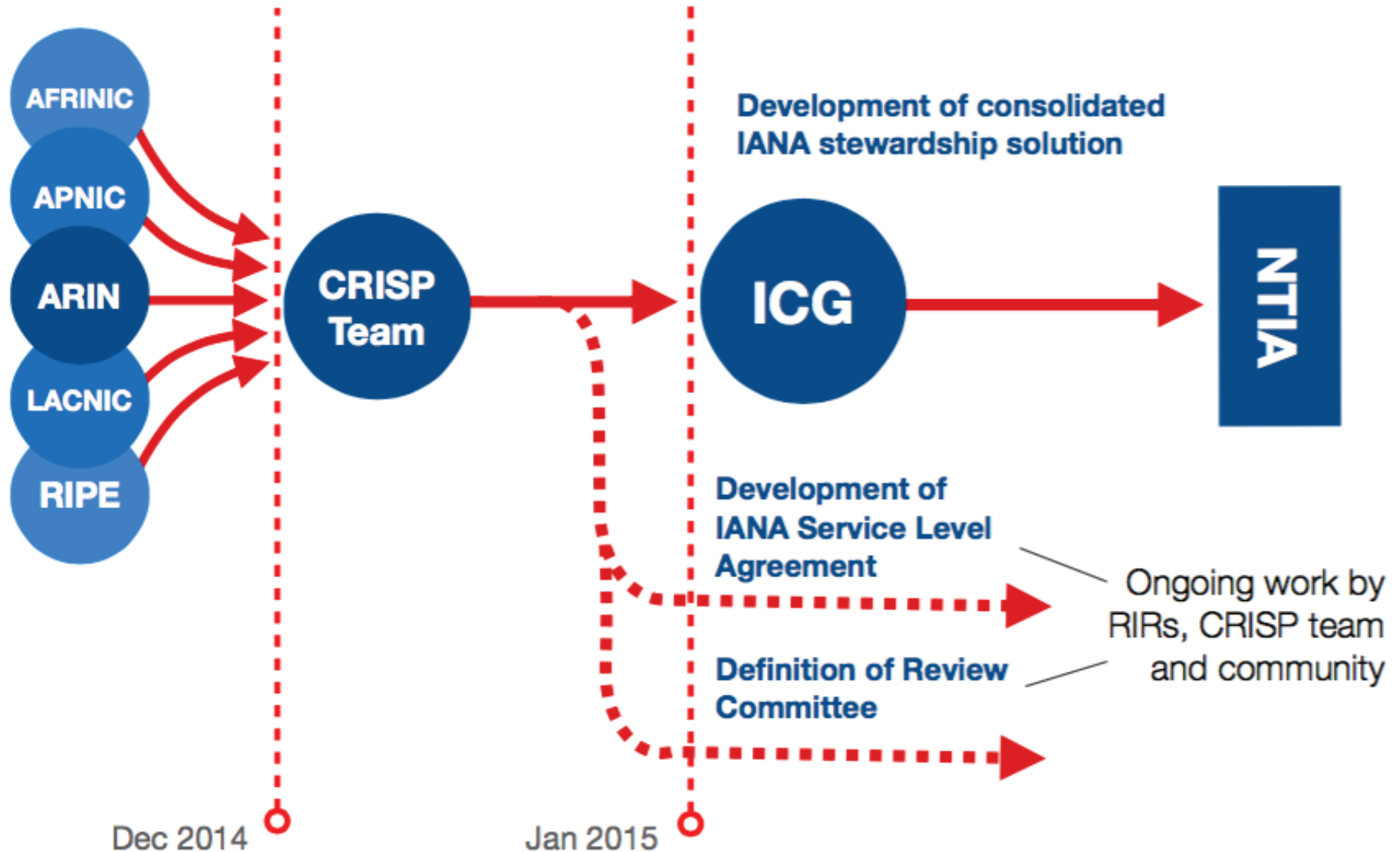

# IANAPLAN WG: Proposal Development Overview

Protocol Parameters Community

## What are Protocol Parameters?

A database of values or mnemonics associated with specific behaviors for IETF protocols

### **Example:**

*TCP port number 80 means payload will be HTTP (the web)*

Developers use these parameters for their implementations

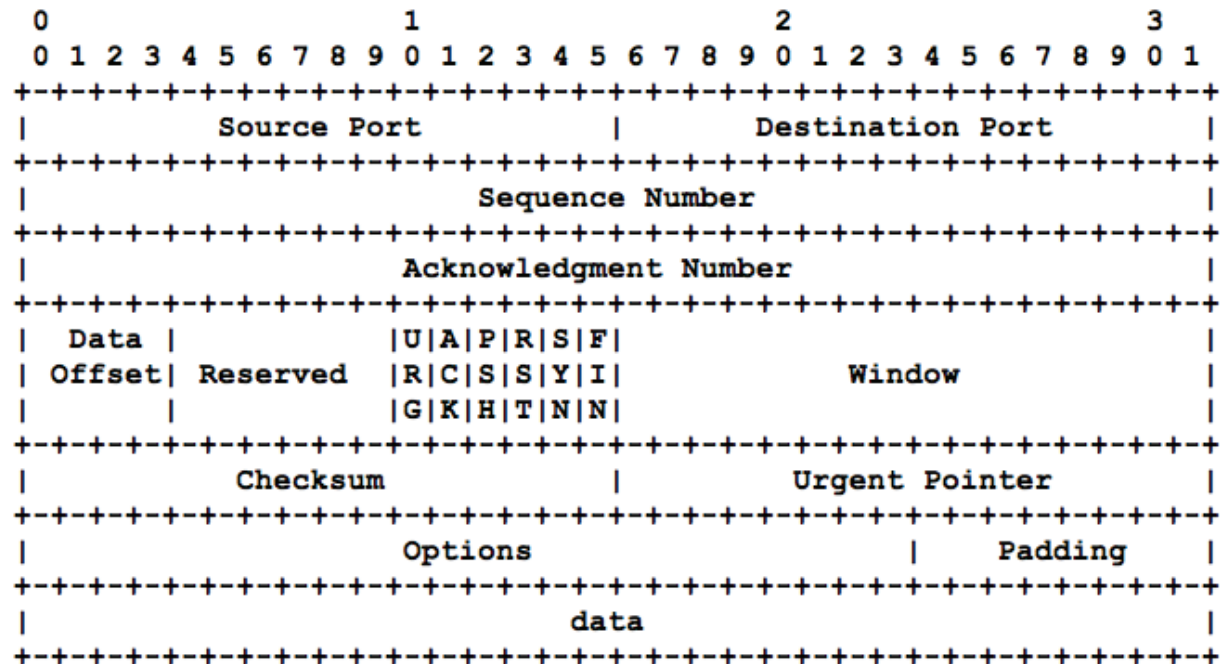

TCP Header Format

## IANAPLAN WG: **Proposal Development Overview**

Protocol Parameters Community

### **How things work today:**

IETF specifications create registries of values and the policies to update those values.  
*(Anyone with an email address may participate in the IETF).*

Any individual may apply for an assignment for a specific protocol parameter.

Applications are considered by IETF-designated experts or by the IETF, strictly based on the policy associated with the registry.

All decisions are subject to dispute resolution.

# IANAPLAN WG: Proposal Development Overview

Protocol Parameters Community

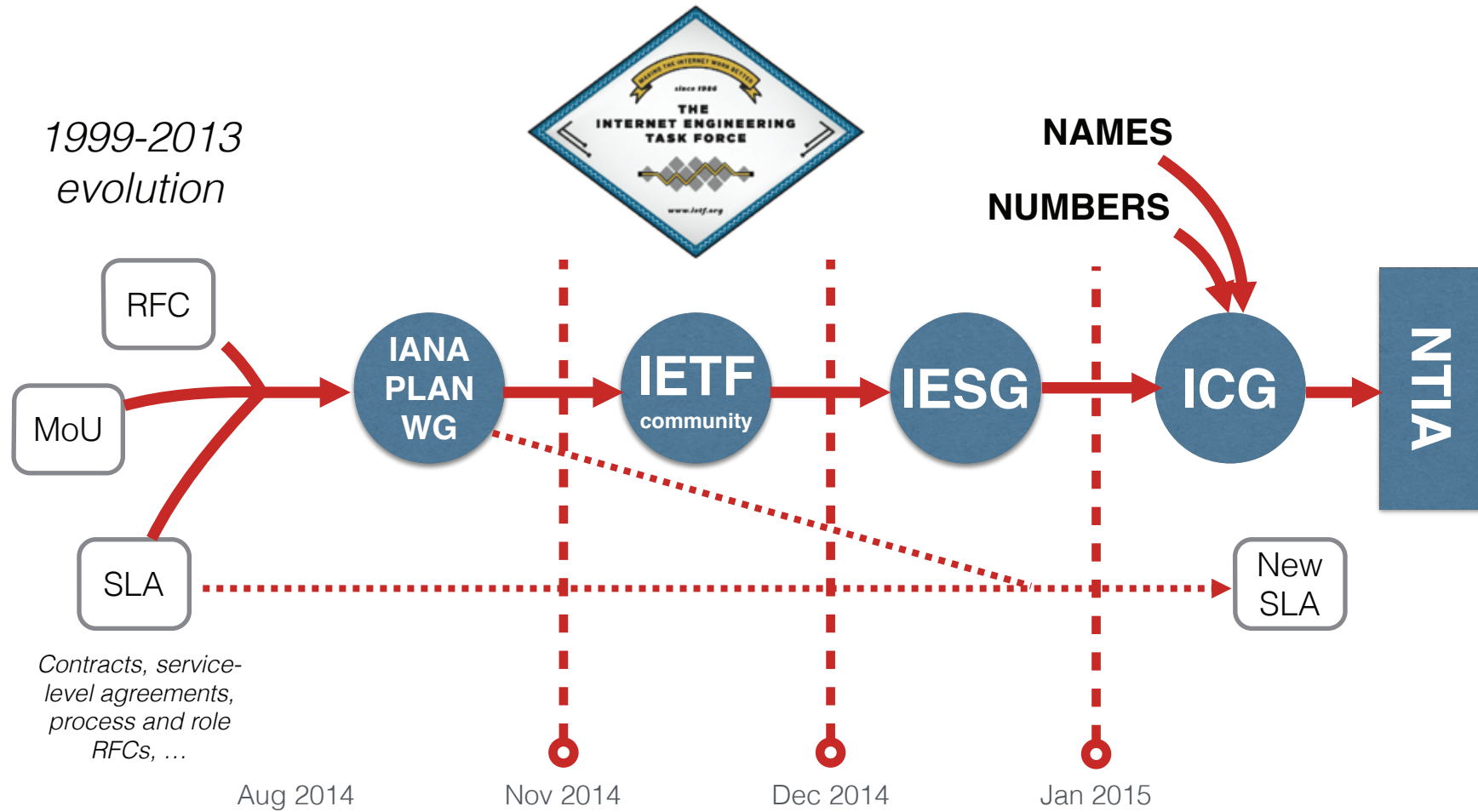

## IANAPLAN WG: **Submission**

Protocol Parameters Community

The IETF community are **very satisfied** with the current arrangement.

**No major changes** to the structure or the nature of our relationship with ICANN are needed.

Available at: <http://datatracker.ietf.org/doc/draft-ietf-ianaplan-icg-response/>

# Questions & Answers