

# IANA Stewardship Transition

A Live Example of a Multistakeholder Process

## WSIS Forum

28 May 2015

# IANA Stewardship Transition: The Big Picture

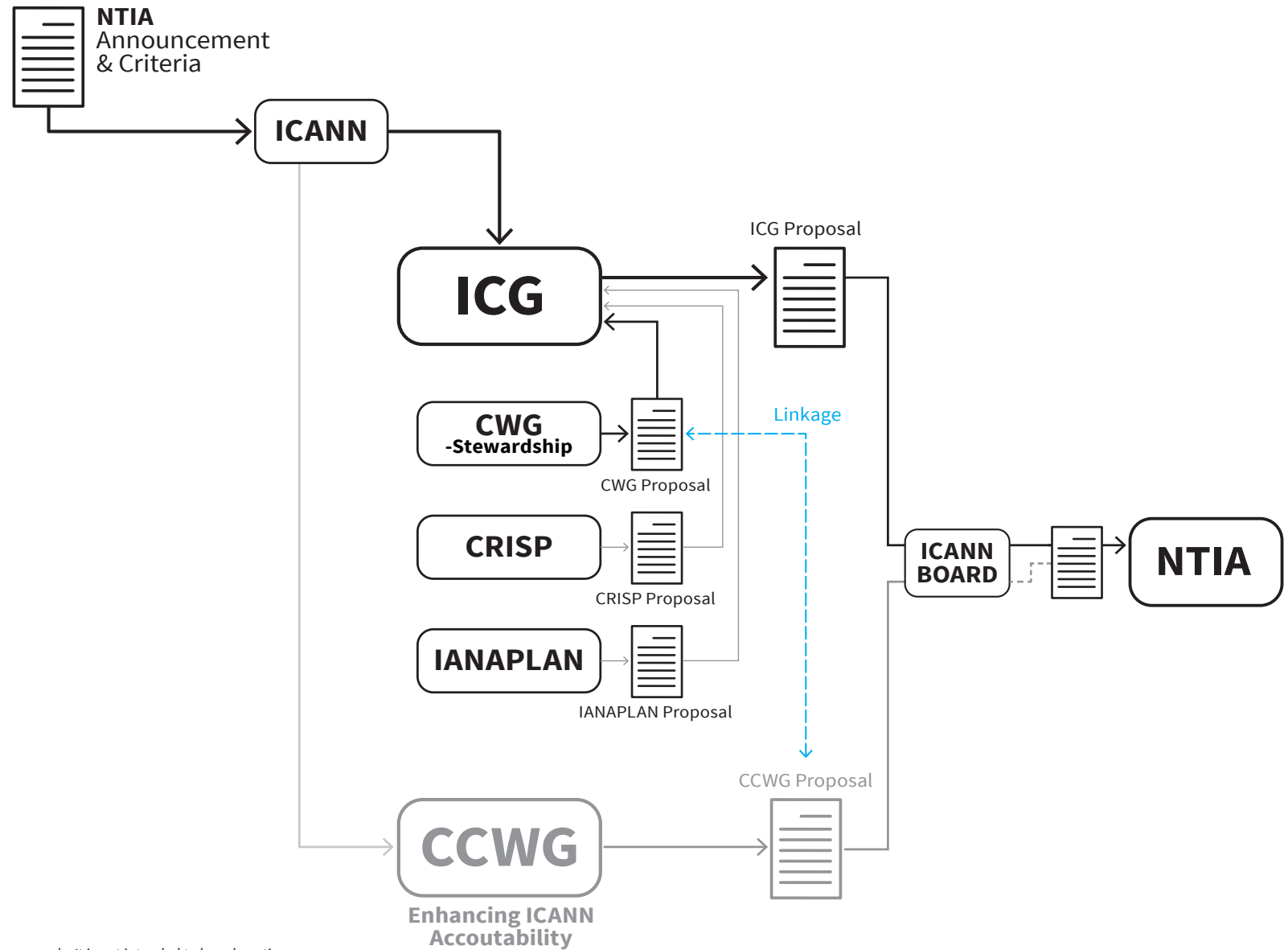

Note: the information on this page is for illustrative purposes only. It is not intended to be exhaustive.

# IANA Stewardship Transition Coordination Group: **Composition**

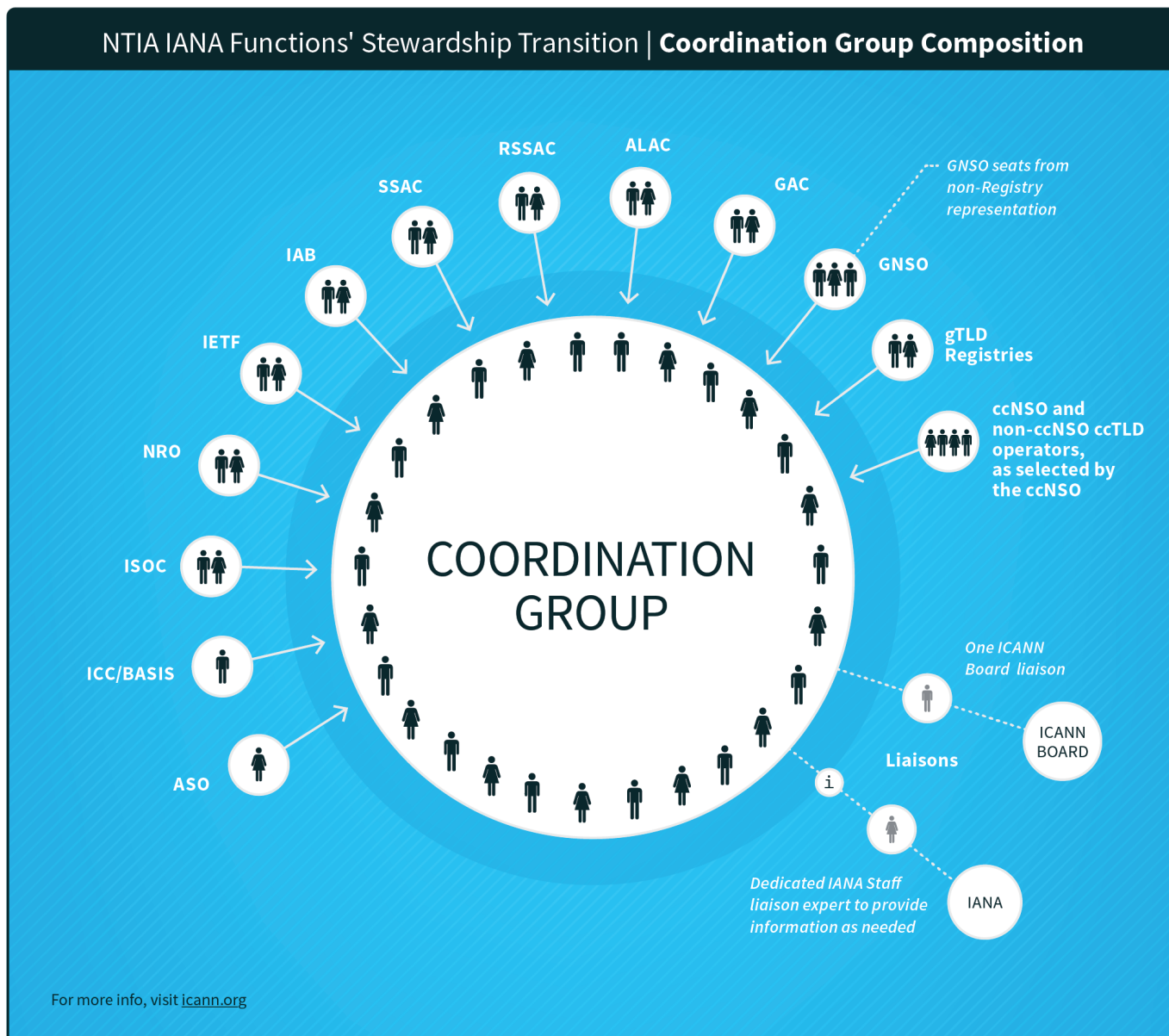

# CWG-Stewardship: Timeline • Progress to Date

Domain Names Community

Note: the information on this page is for illustrative purposes only. It is not intended to be exhaustive.

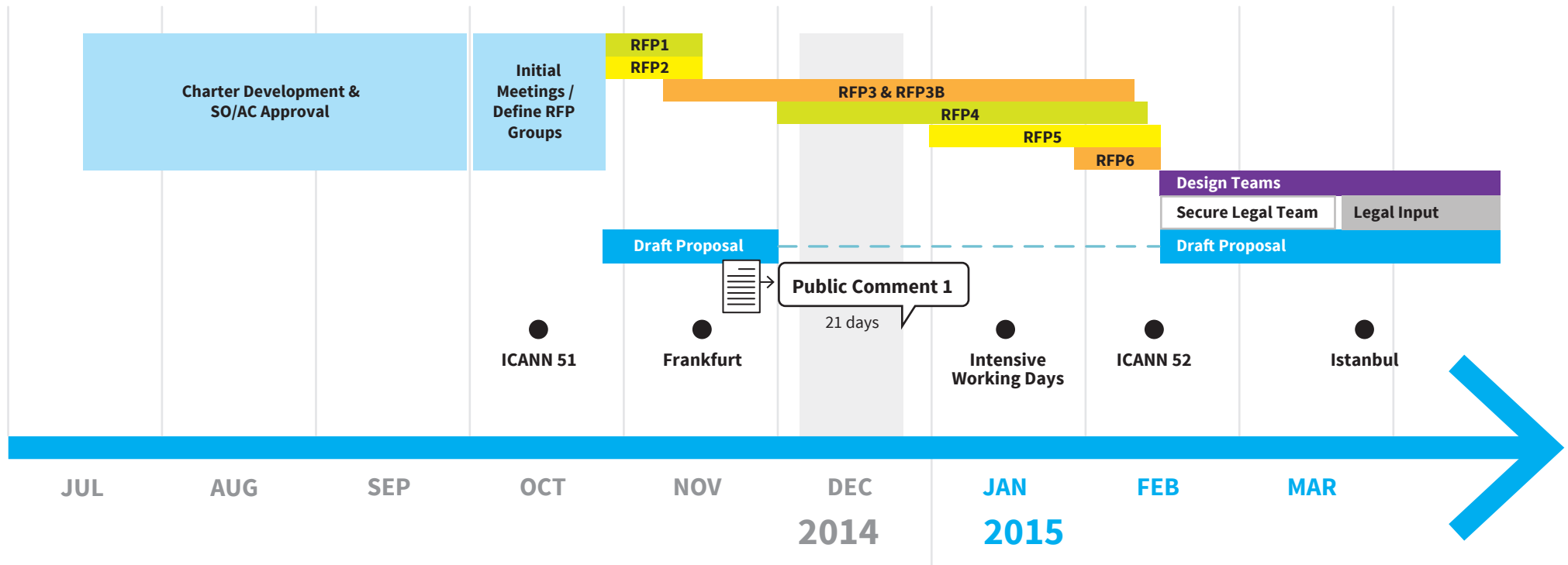
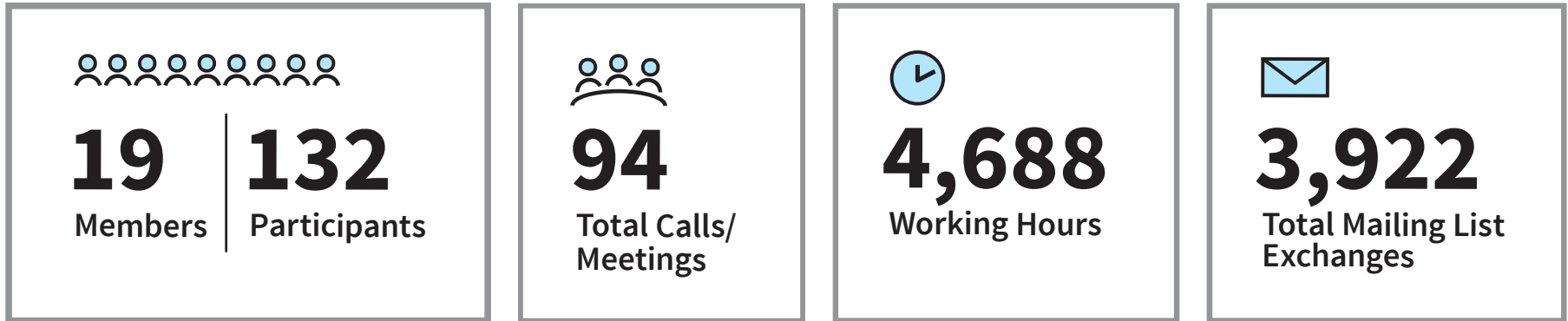

# CWG-Stewardship: Proposal Development Overview

Domain Names Community

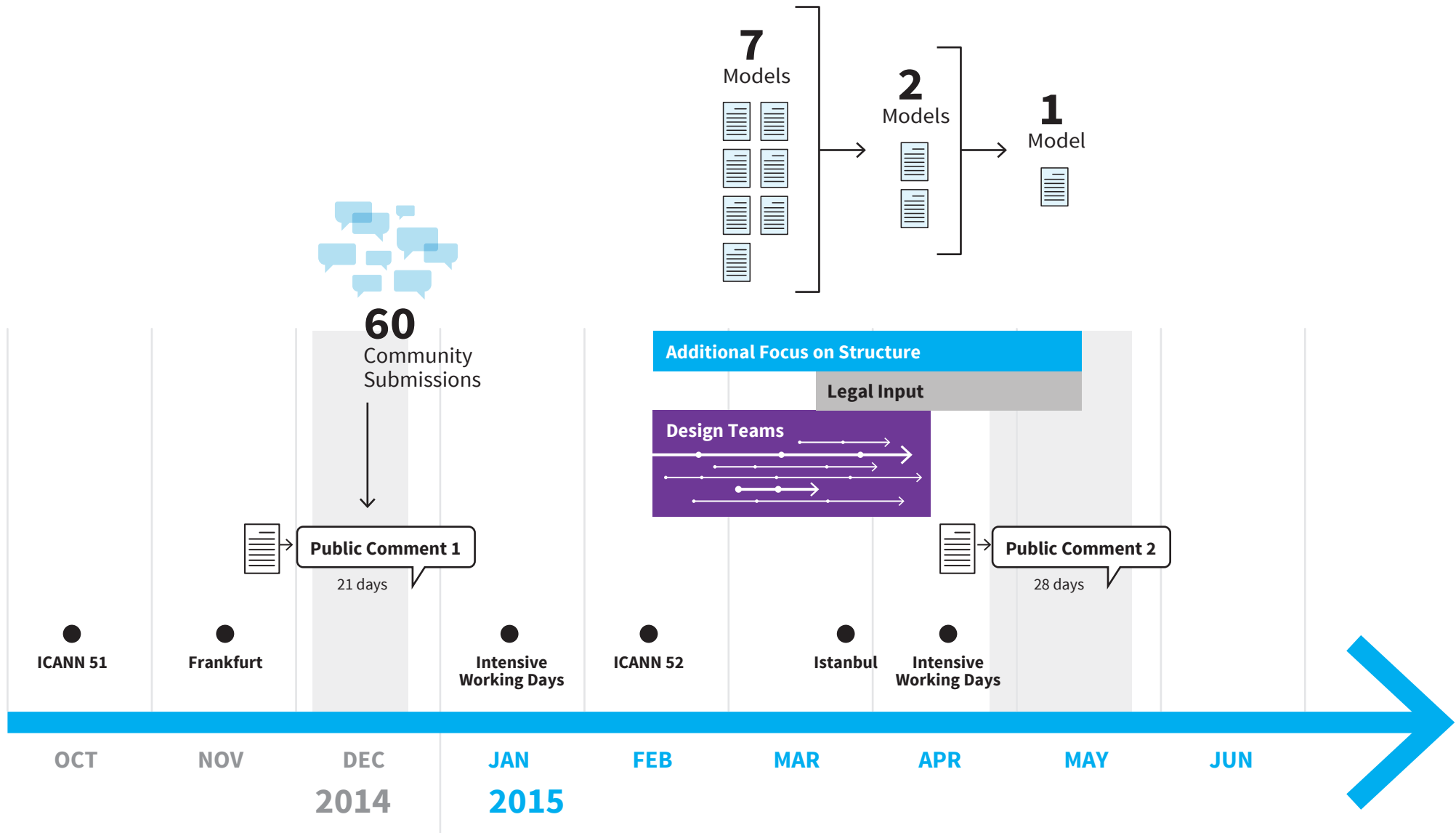

# CWG-Stewardship: Timeline • The Road Ahead

Domain Names Community

Note: the information on this page is for illustrative purposes only. It is not intended to be exhaustive.

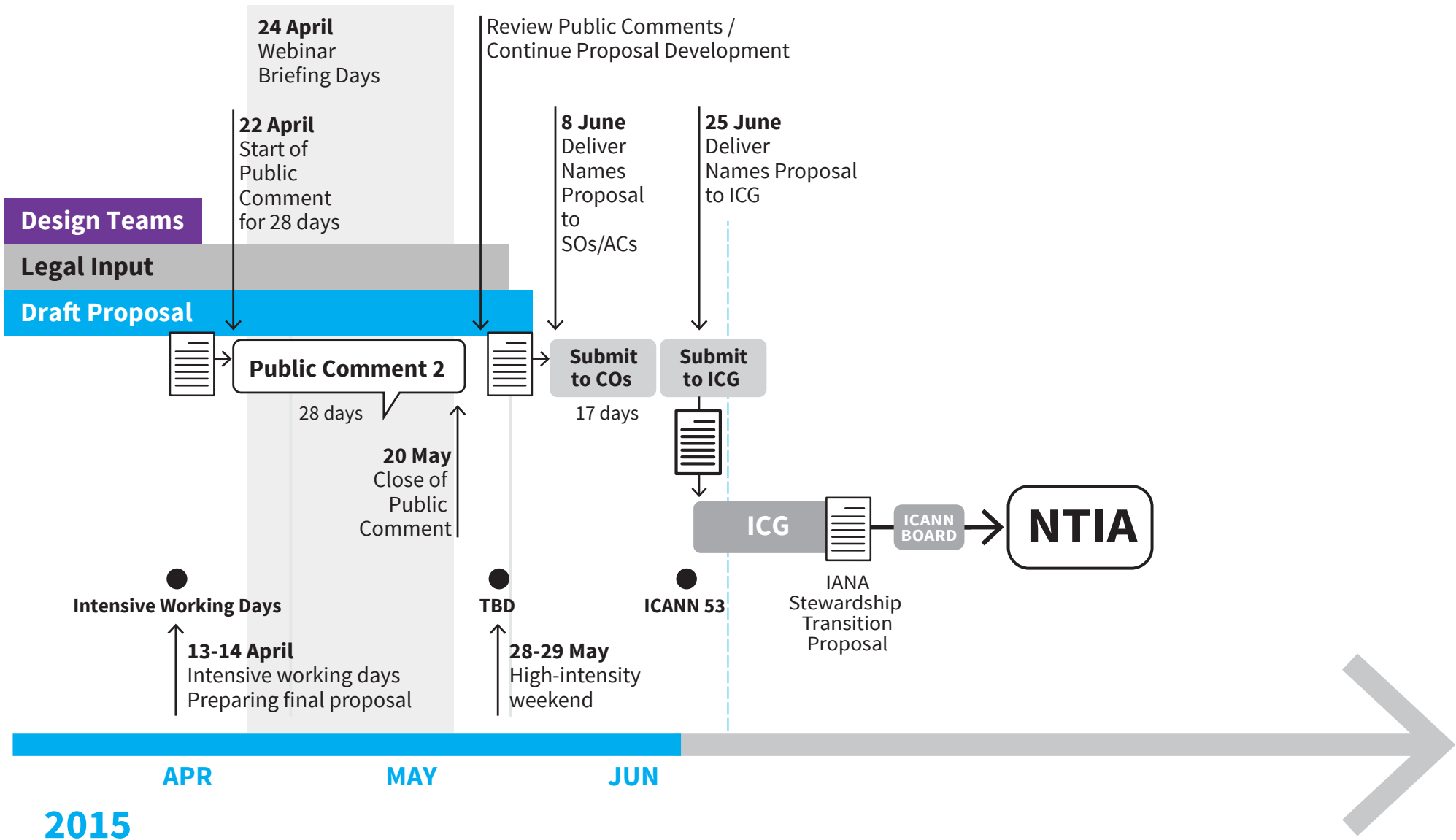

# Enhancing ICANN Accountability: The Big Picture

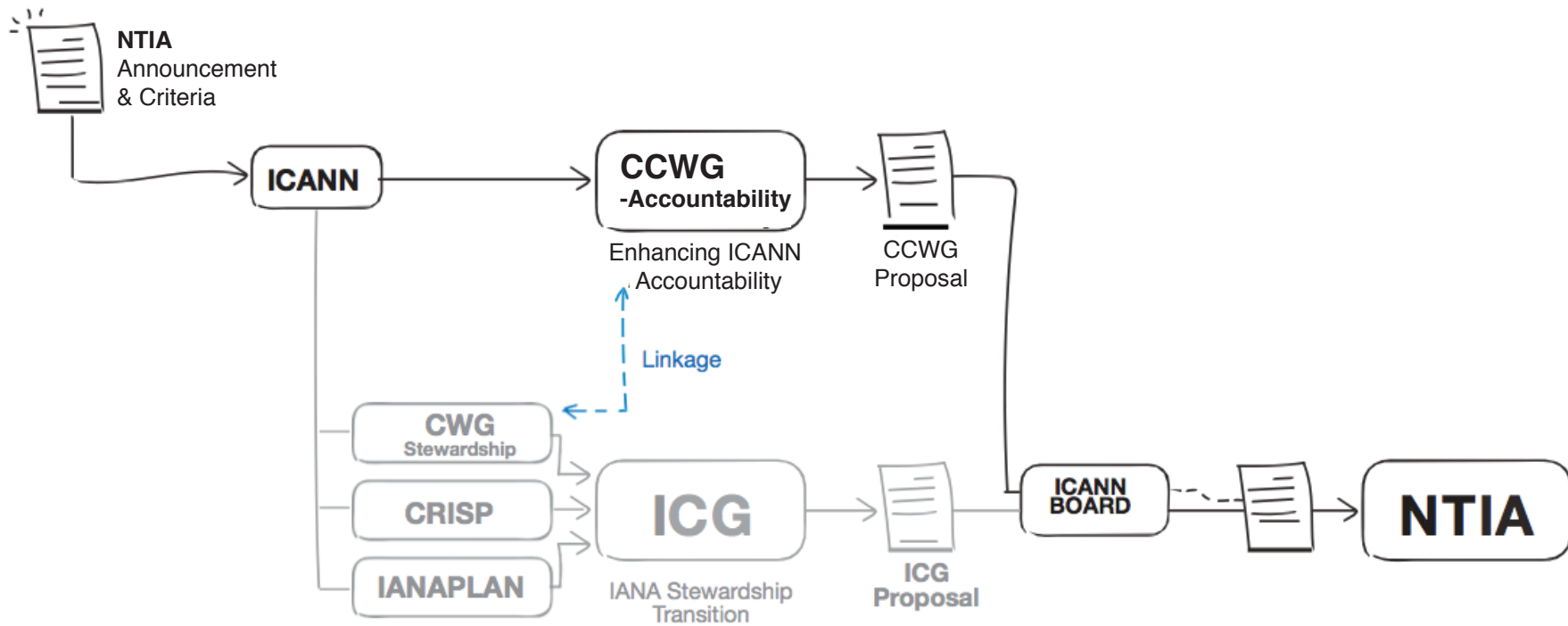

# CCWG-Accountability: Timeline • Progress to Date

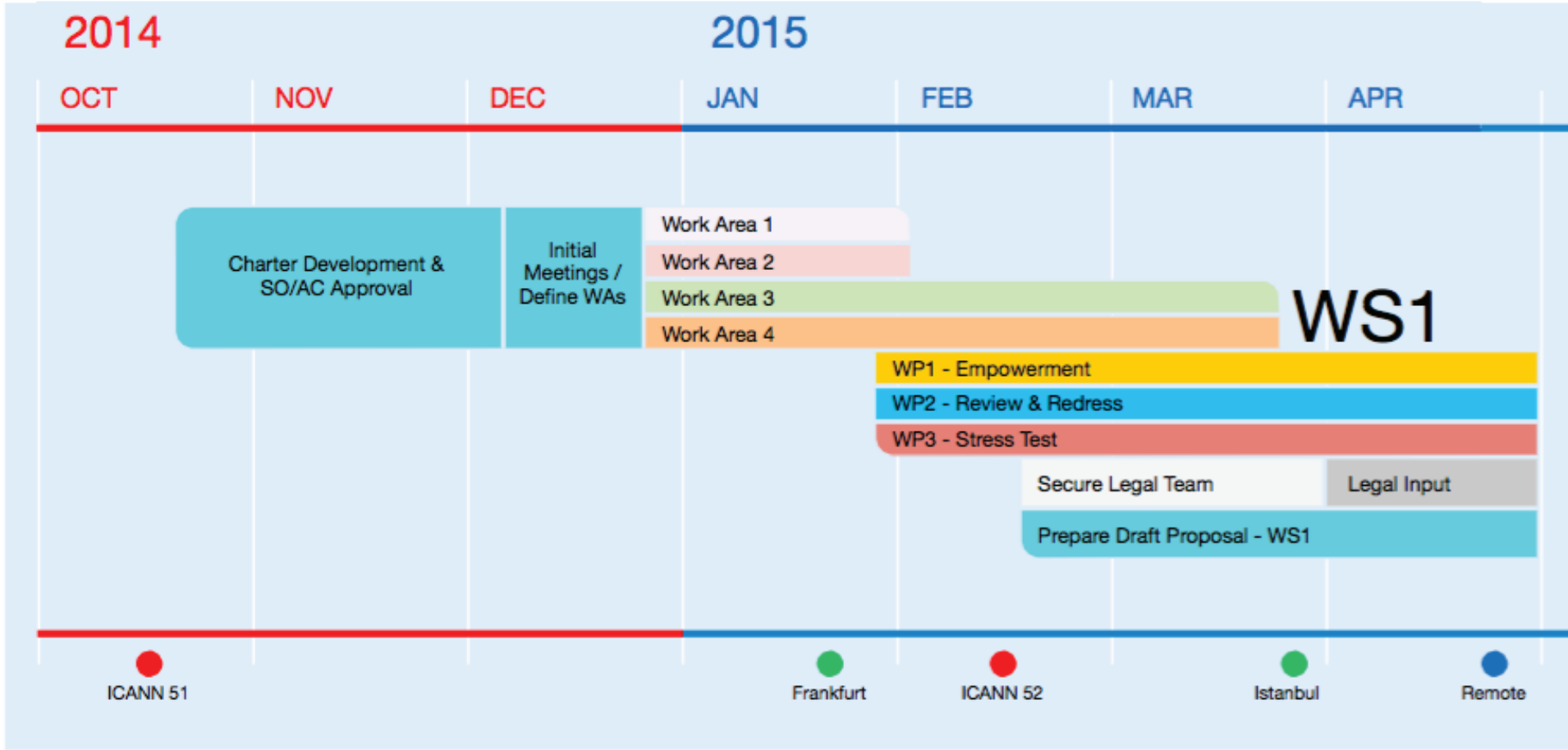
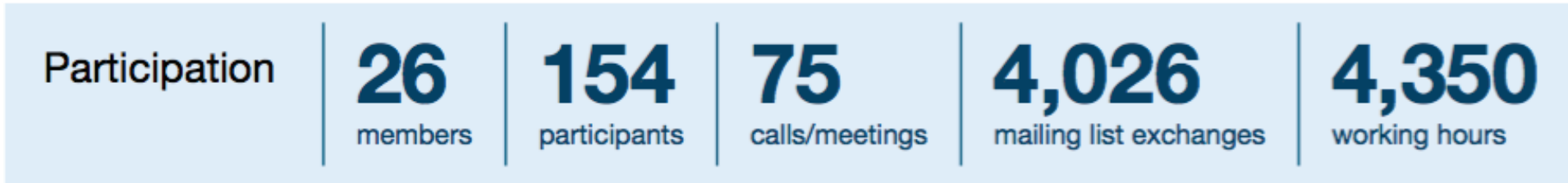



# CCWG-Accountability: Timeline • The Road Ahead

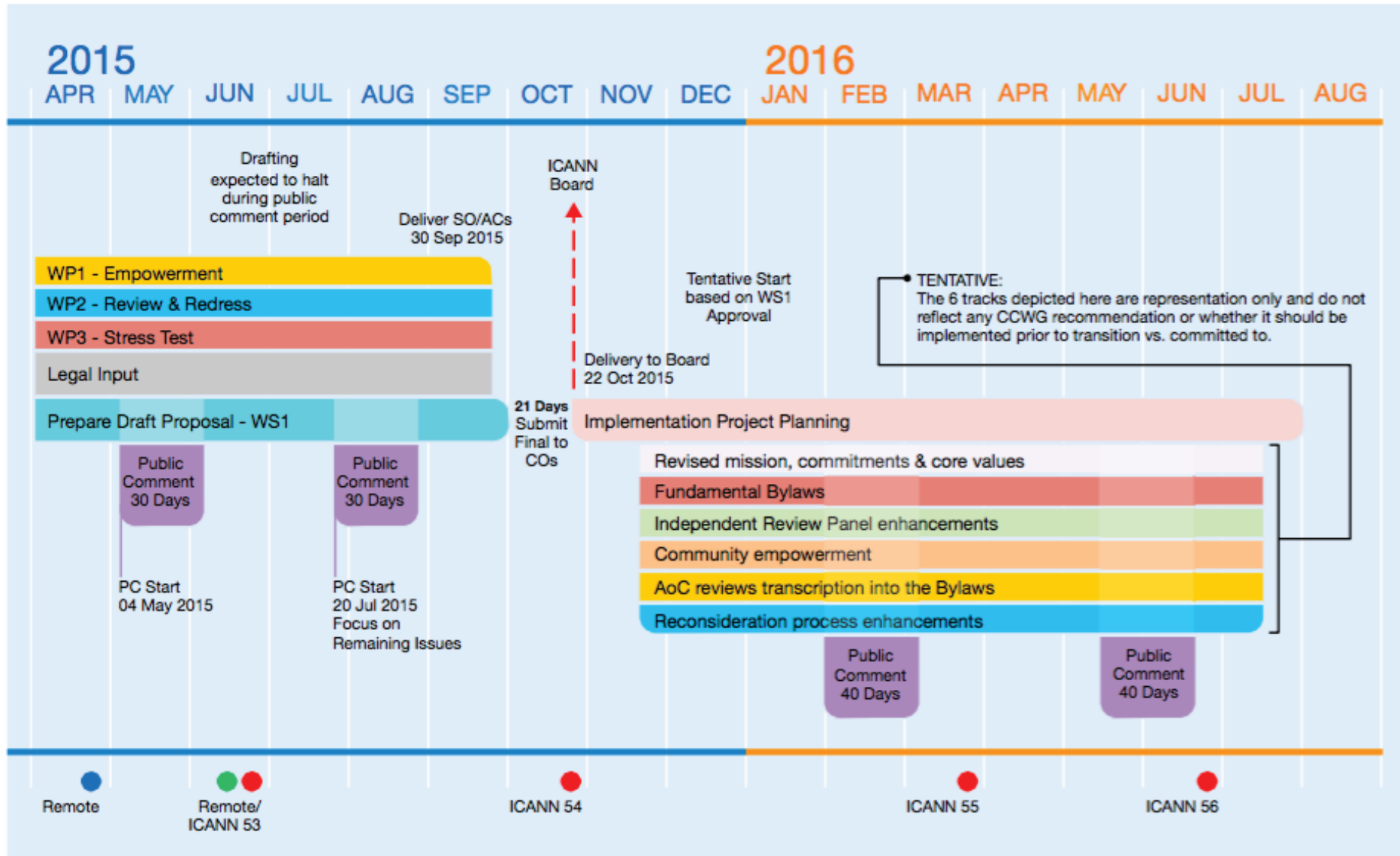

## CRISP Team: **Proposal Development Overview**

### Numbering Resources Community

- **June 2014**
  - IANA Stewardship Transition Coordination Group (ICG) issues Request for Proposals to three IANA “affected communities”
- **Q4 2014**
  - Consolidated RIR IANA Stewardship Proposal Team (CRISP Team) established to prepare an Internet numbers community proposal
  - Global discussion platform established: [ianaxfer@nro.net](mailto:ianaxfer@nro.net)
- **January 2015**
  - Internet numbers community IANA stewardship proposal submitted to the ICG

# CRISP Team: Proposal Development Overview

Numbering Resources Community

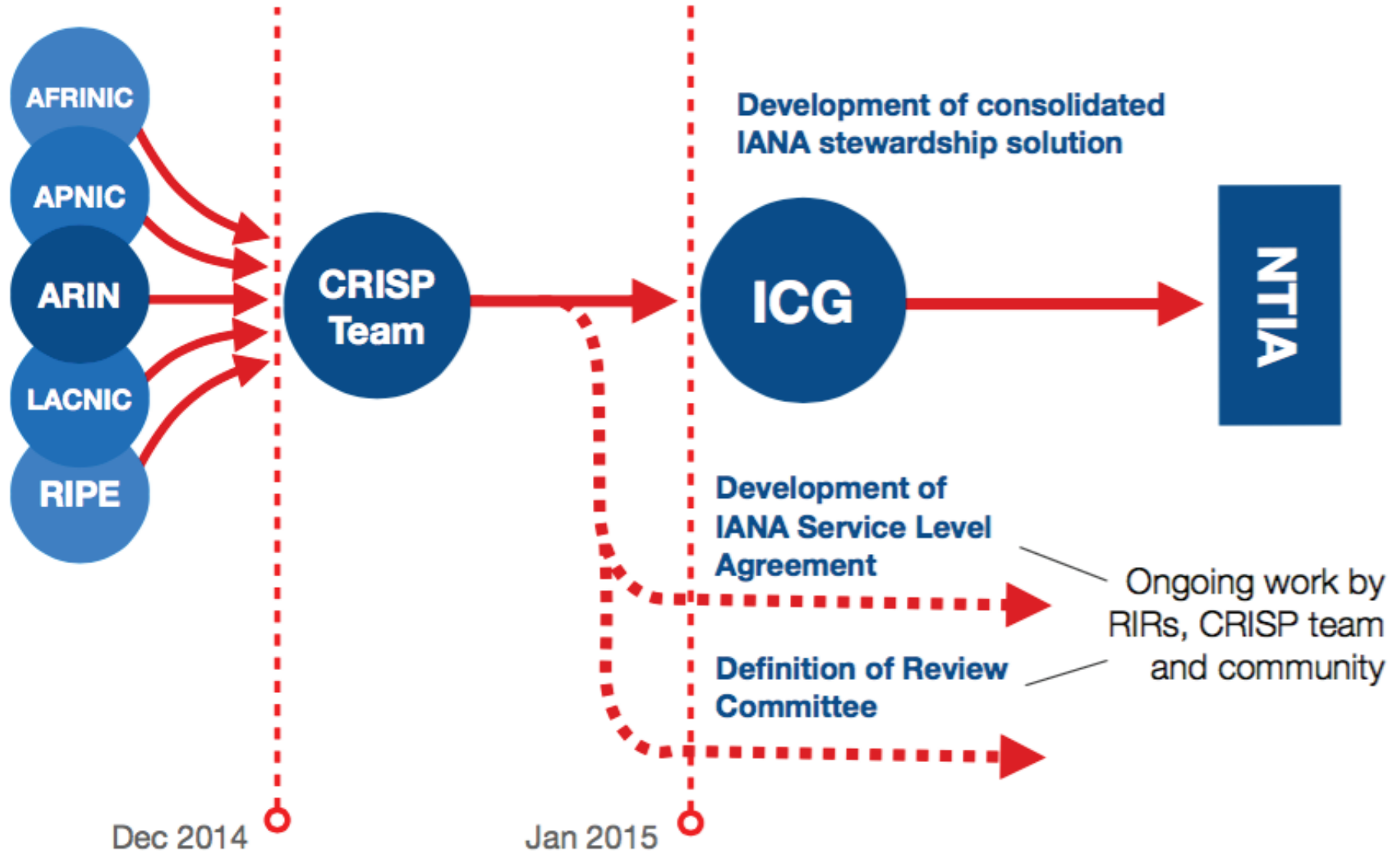

# IANAPLAN WG: Proposal Development Overview

Protocol Parameters Community

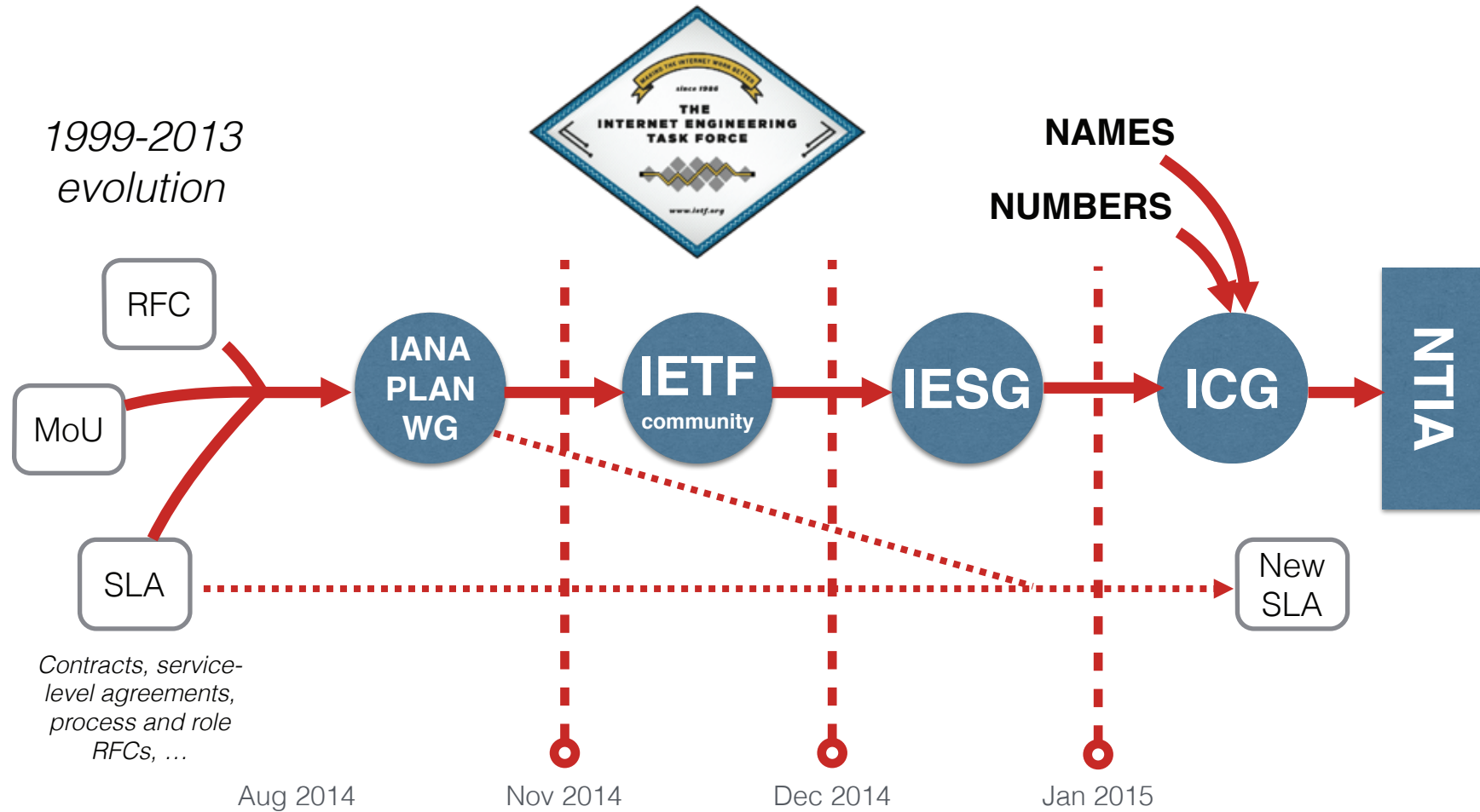

# Questions & Answers