

IANA Stewardship Transition

A Live Example of a Multistakeholder Process

WSIS Forum

28 May 2015

IANA Stewardship Transition: The Big Picture

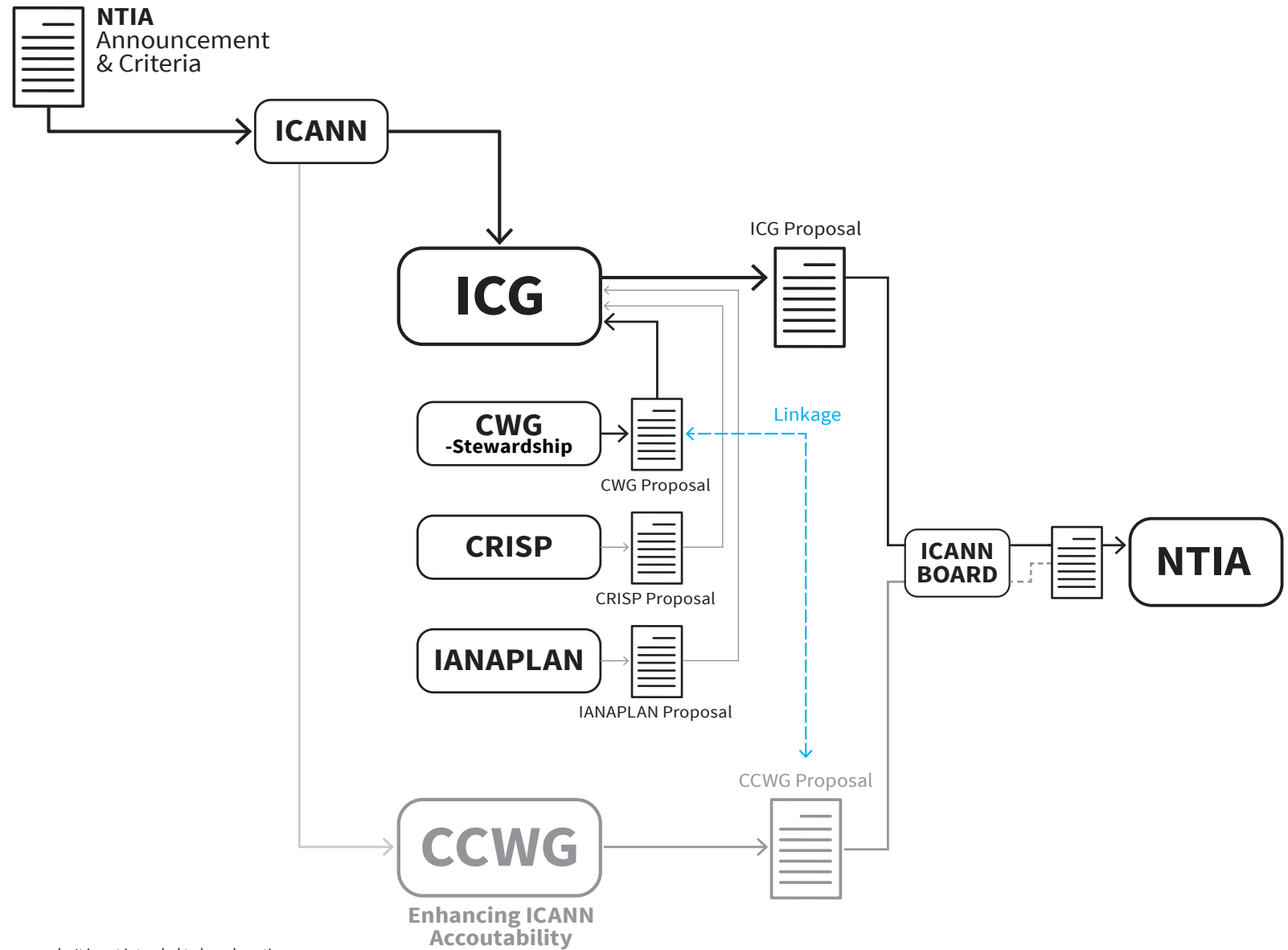

Note: the information on this page is for illustrative purposes only. It is not intended to be exhaustive.

IANA Stewardship Transition Coordination Group: **Composition**

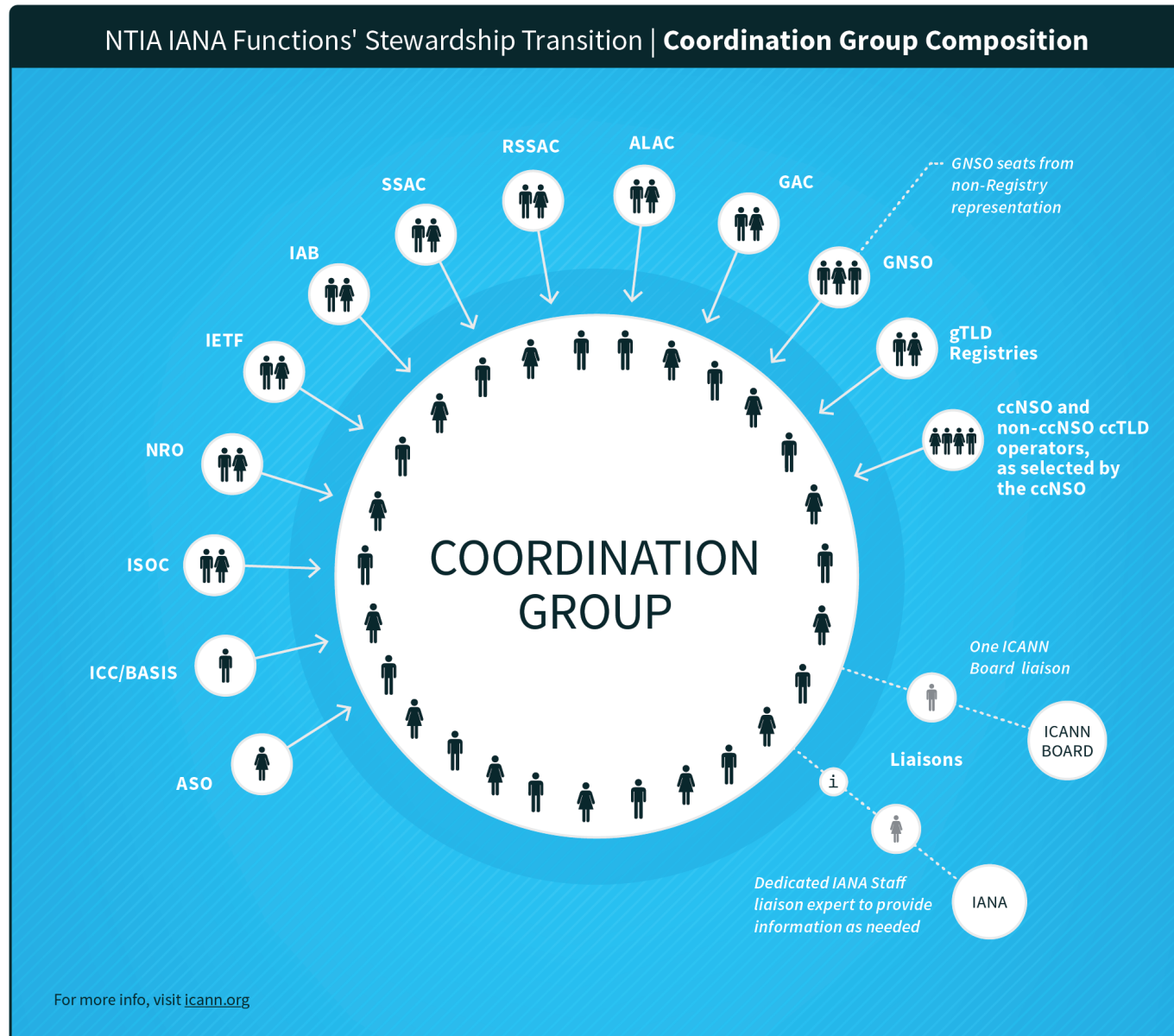

CWG-Stewardship: Timeline • Progress to Date

Domain Names Community

Note: the information on this page is for illustrative purposes only. It is not intended to be exhaustive.

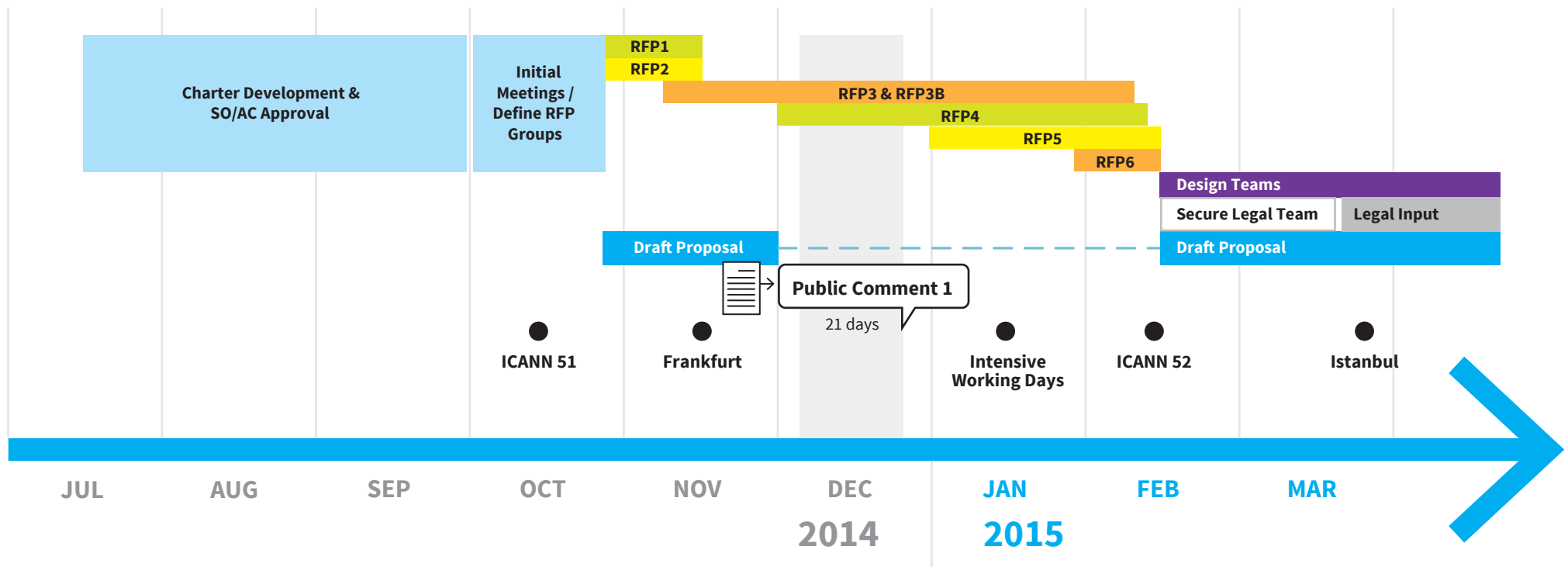
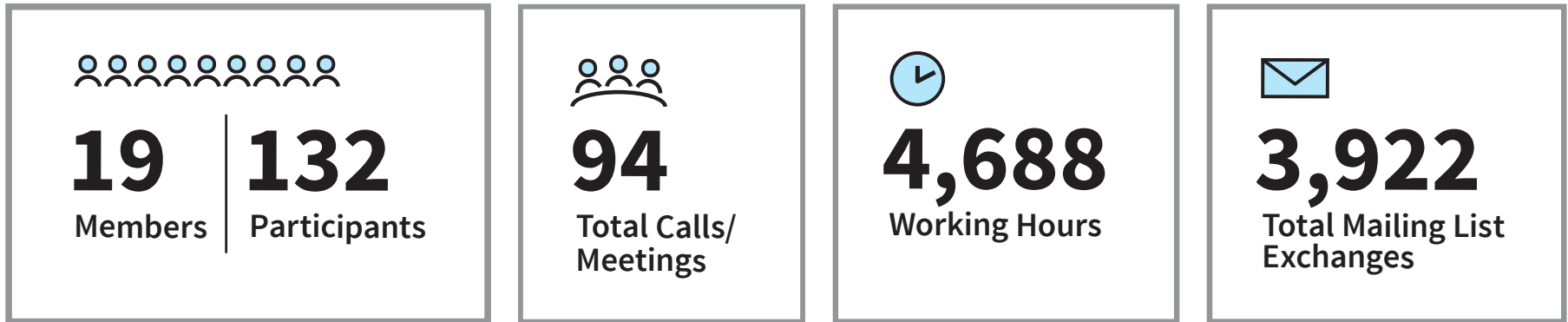

CWG-Stewardship: Proposal Development Overview

Domain Names Community

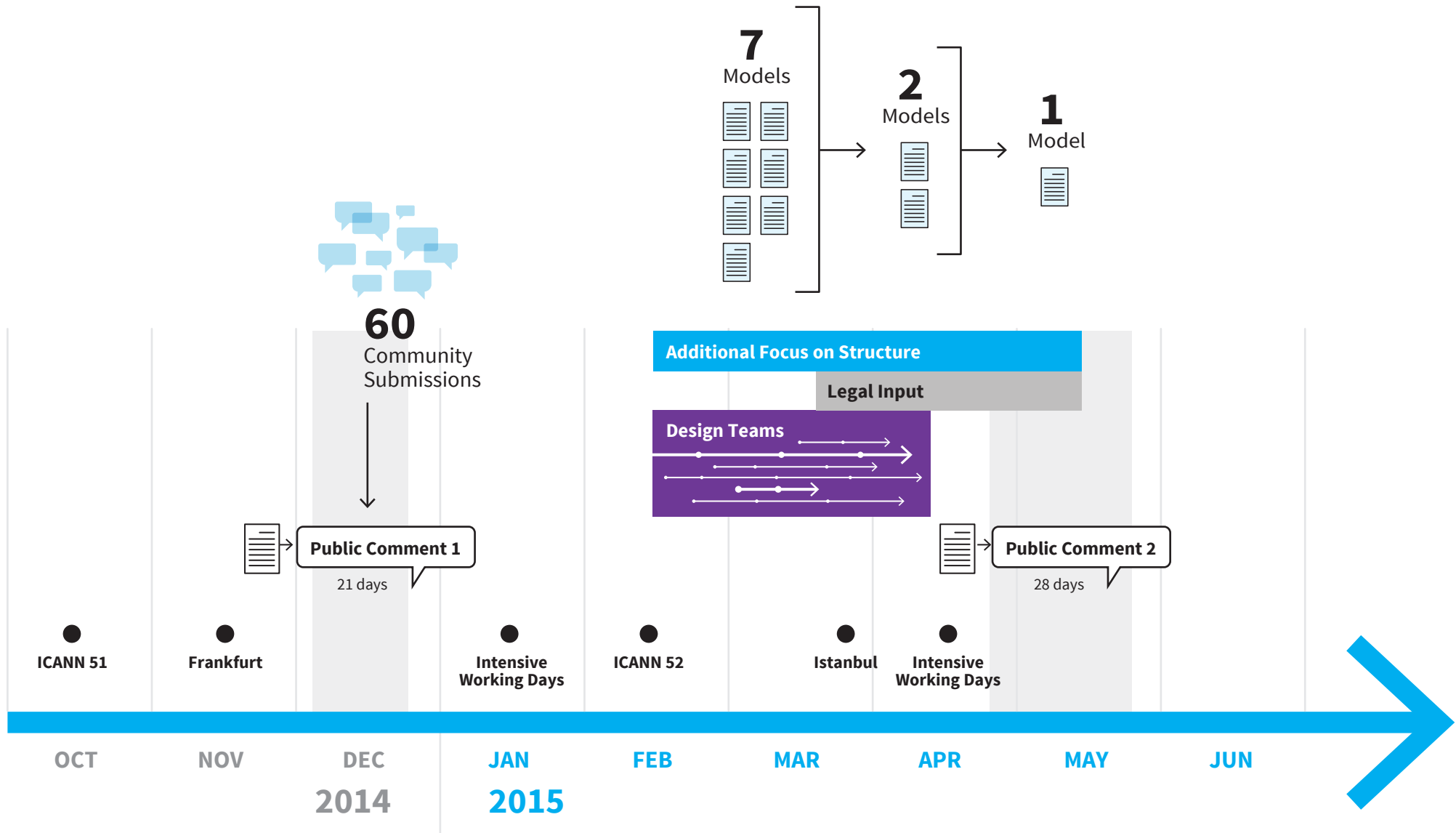

CWG-Stewardship: Timeline • The Road Ahead

Domain Names Community

Note: the information on this page is for illustrative purposes only. It is not intended to be exhaustive.

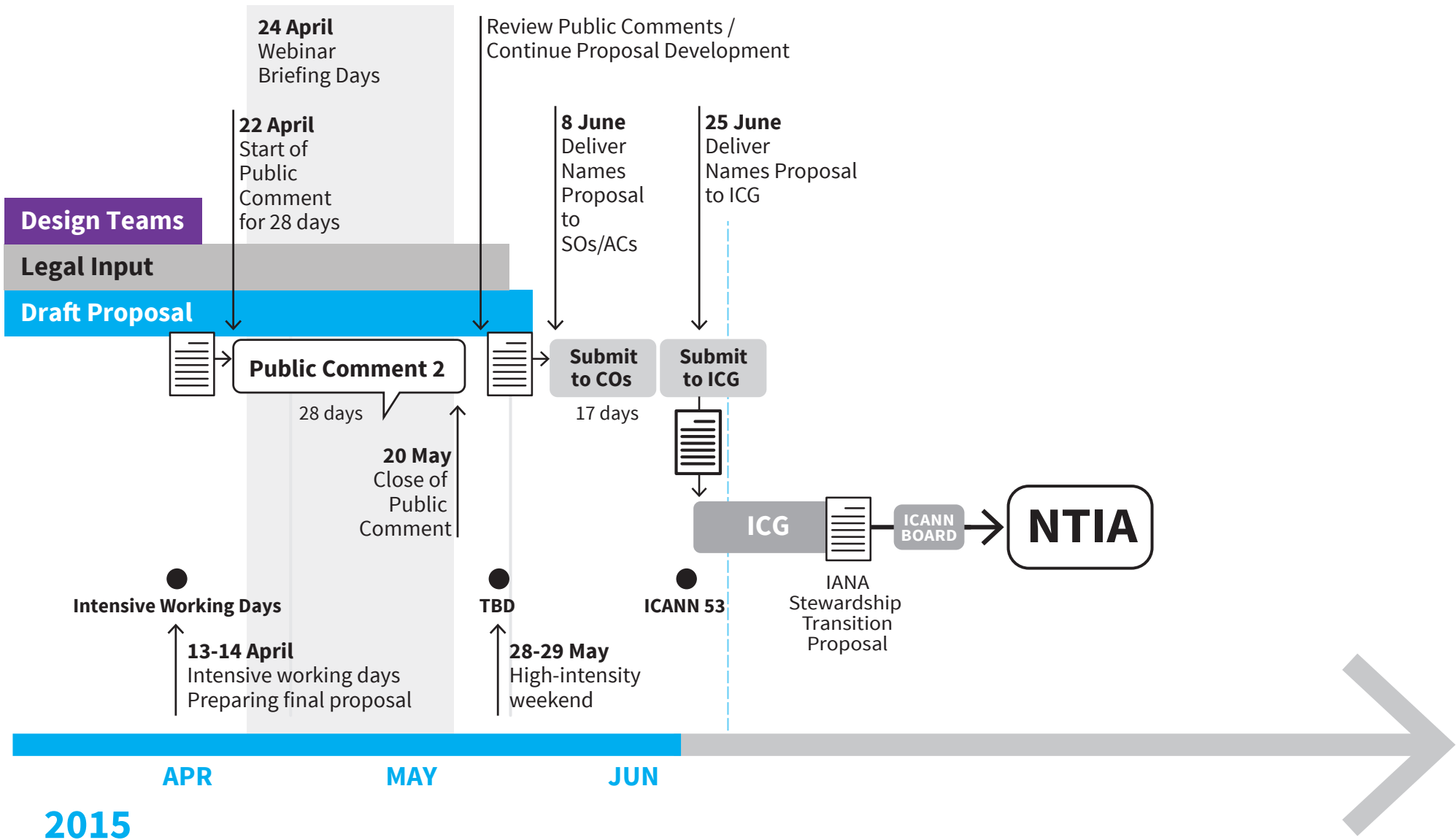

2015

Enhancing ICANN Accountability: The Big Picture

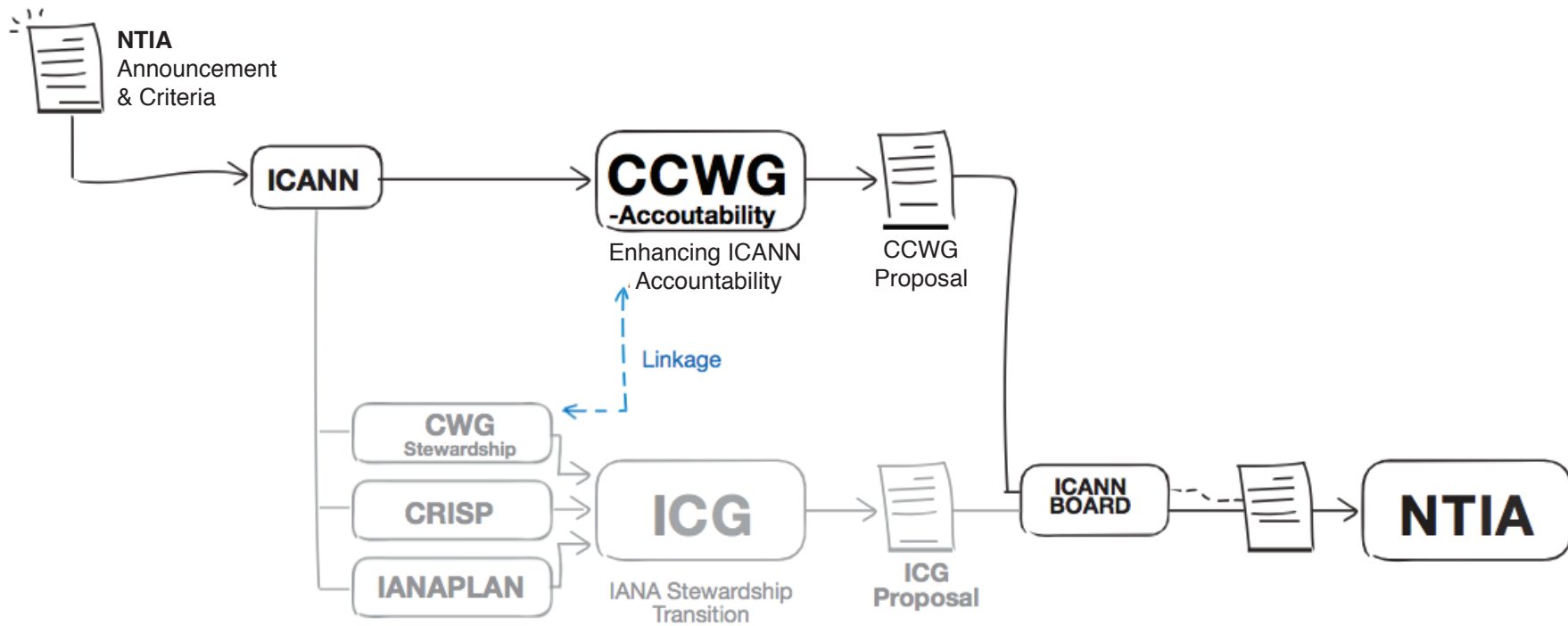

CCWG-Accountability: Timeline • Progress to Date

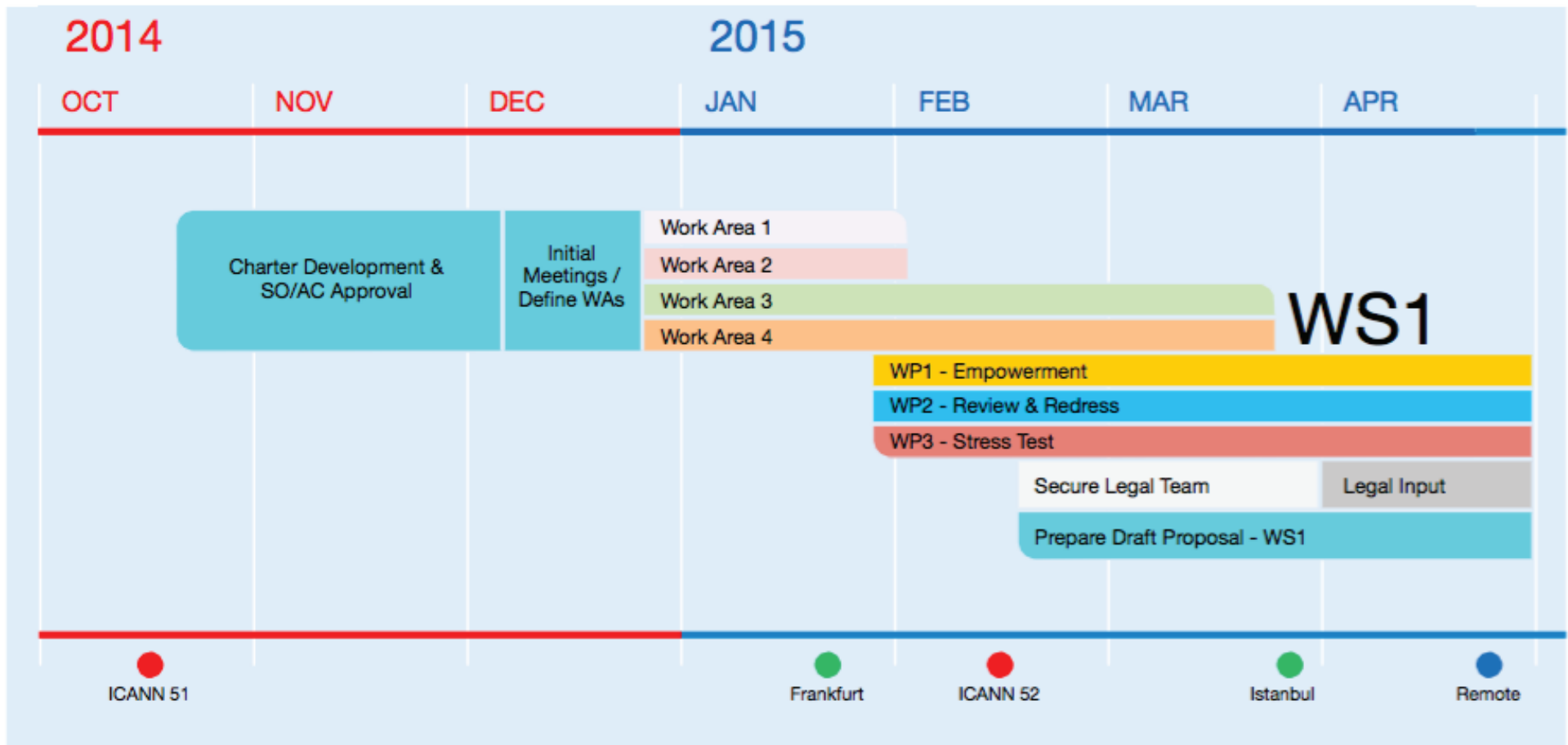
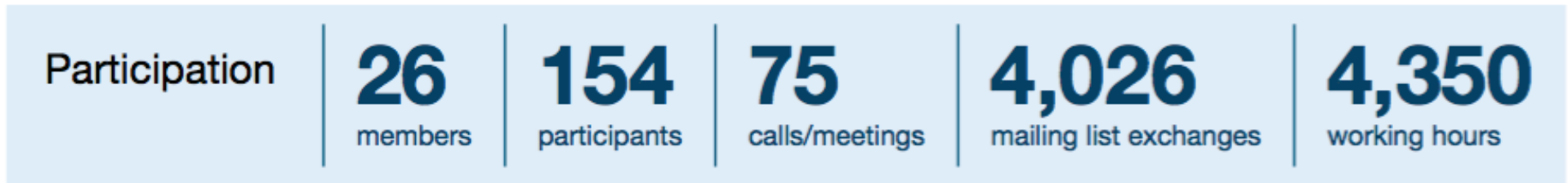

CCWG-Accountability: Timeline • The Road Ahead

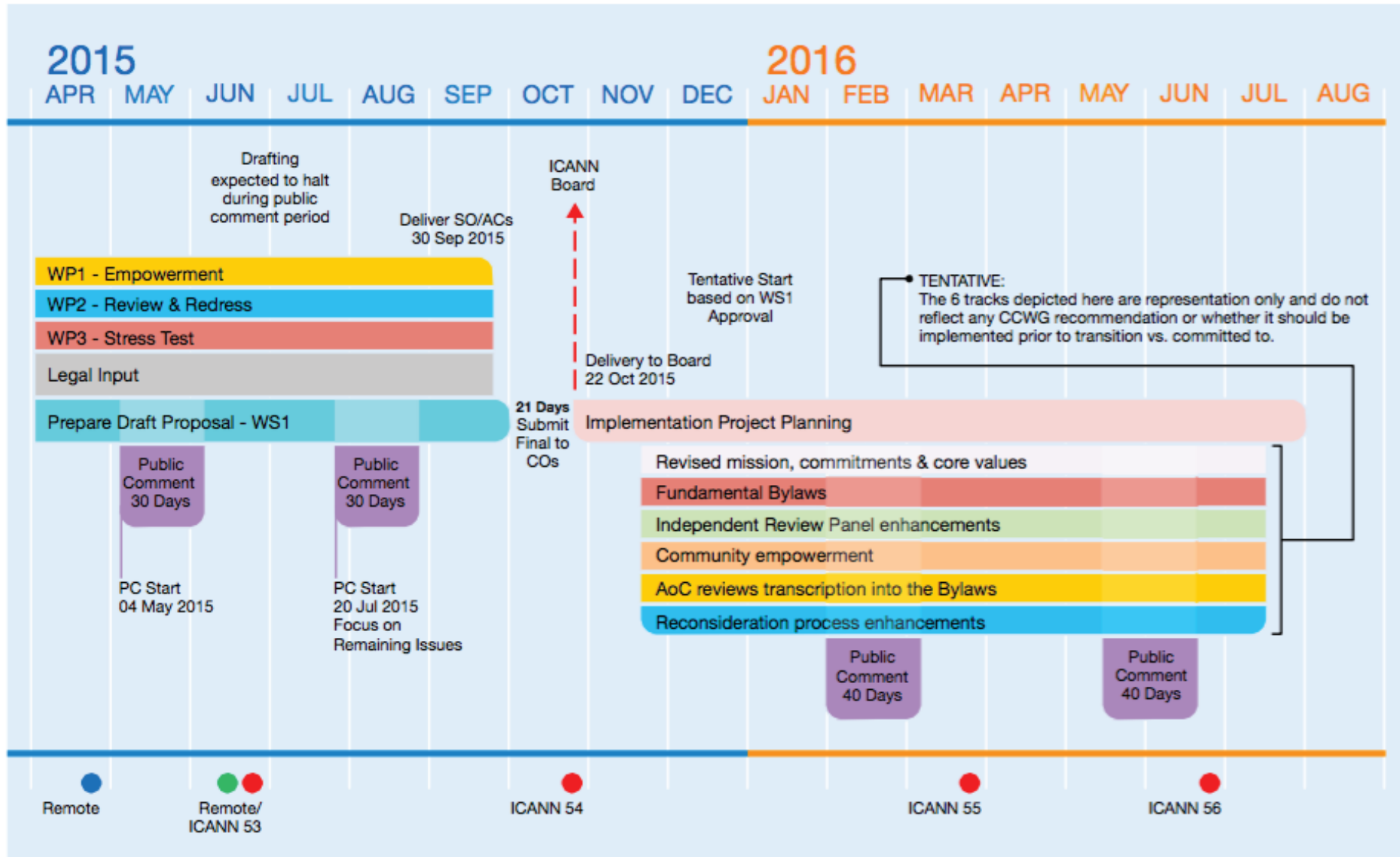

CRISP Team: **Proposal Development Overview**

Numbering Resources Community

- **June 2014**
 - IANA Stewardship Transition Coordination Group (ICG) issues Request for Proposals to three IANA “affected communities”
- **Q4 2014**
 - Consolidated RIR IANA Stewardship Proposal Team (CRISP Team) established to prepare an Internet numbers community proposal
 - Global discussion platform established: ianaxfer@nro.net
- **January 2015**
 - Internet numbers community IANA stewardship proposal submitted to the ICG

CRISP Team: Proposal Development Overview

Numbering Resources Community

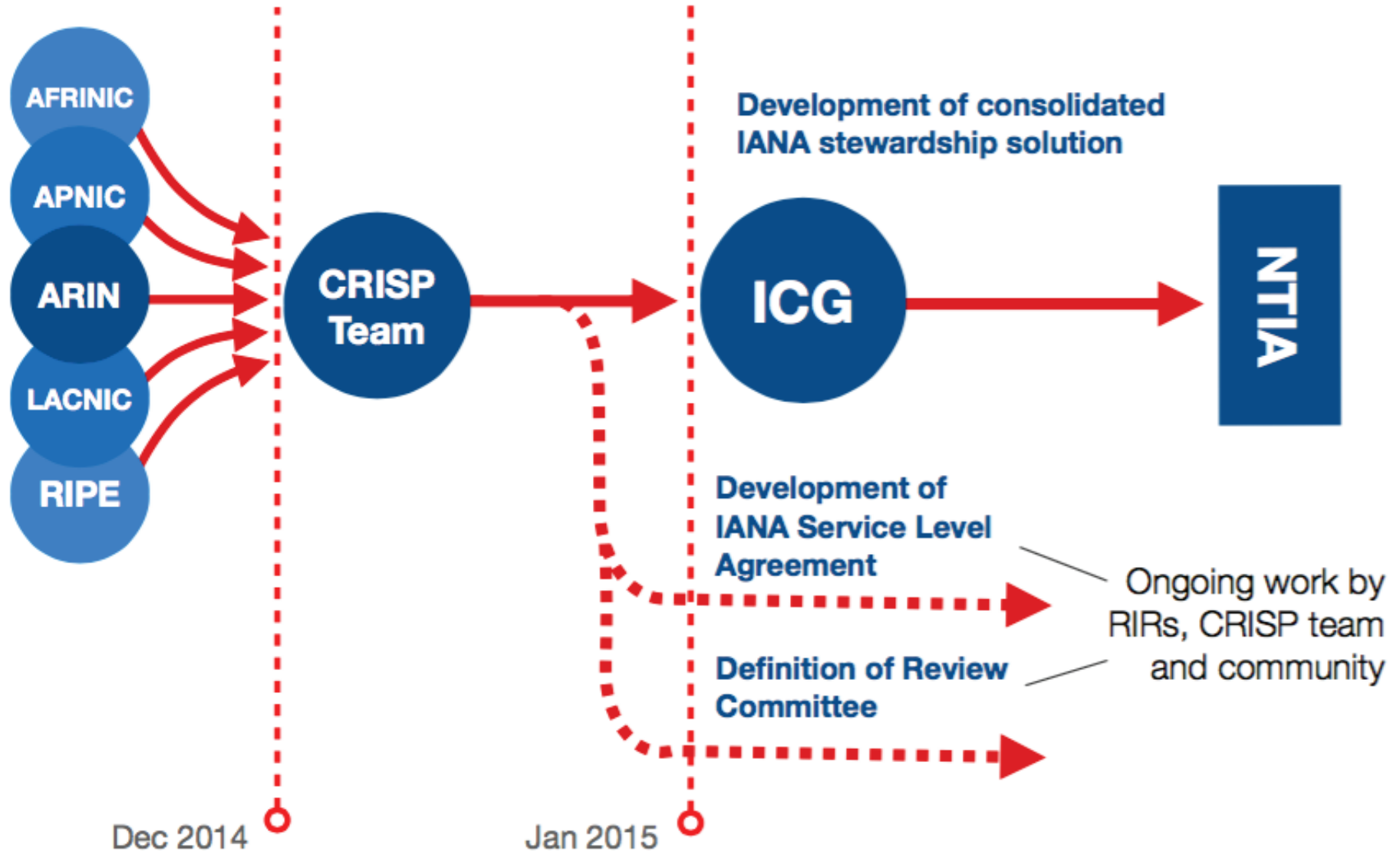

IANAPLAN WG: **Proposal Development Overview**

Protocol Parameters Community