



ICANN | 53 
Buenos Aires

21-25 JUNE 2015

CWG-Stewardship/CCWG-Accountability
Joint Townhall Meeting

22 June 2015



A world map where the continents are defined by a complex network of white dots and thin white lines. The dots vary in size, and the lines connect them to form a web-like structure that outlines the major landmasses. The background is a solid dark blue color.

CWG-Stewardship

Statistics and Diversity

 **19**
Members

 **133**
Participants

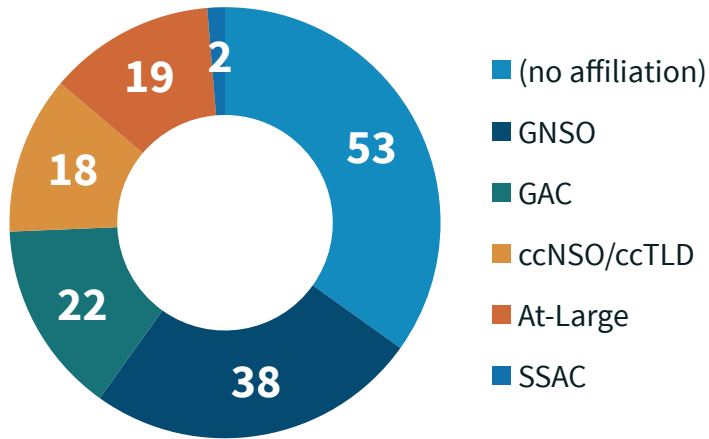

101
Calls/Meetings



4,893
Volunteer Hours



4000+
Mailing List
Messages



35
Average # per
Plenary Meeting

Part of a Process

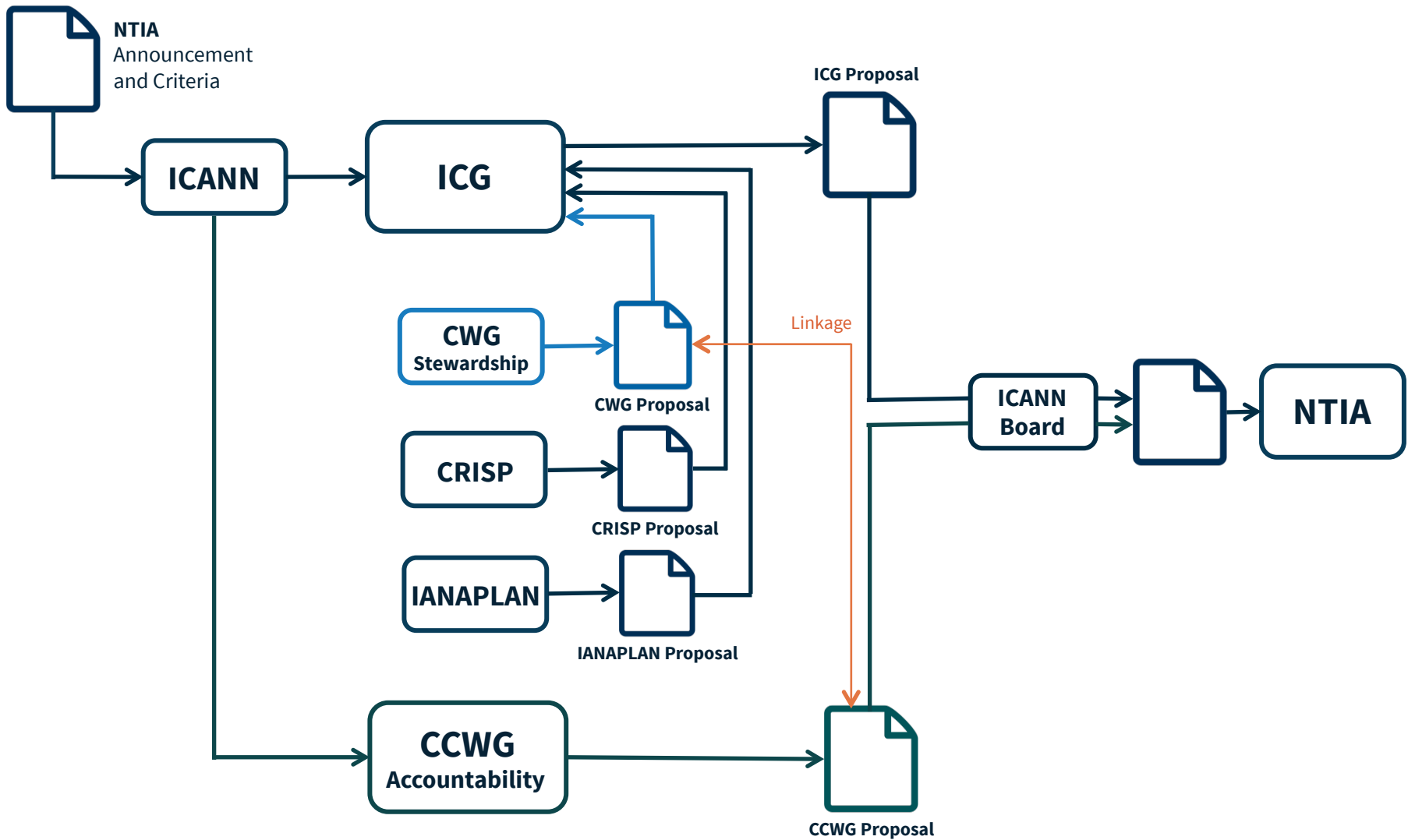

Goals and Requirements

Goal:

Produce a consolidated transition proposal for the elements of the IANA Functions relating to the Domain Name System.

A transition proposal for the Domain Names community would require:



A contract similar to the current IANA functions contract



A mechanism to approve changes to the Root Zone environment



Accountability mechanisms on ICANN with respect to the IANA functions



The ability to ensure adequate funding of the IANA Functions by ICANN



Additional insulation between operational and policymaking responsibilities and protections for the IANA Functions Operator



The ability for the multistakeholder community to require the selection of a new operator for the IANA Functions, if necessary

Structural Overview

Current Contract

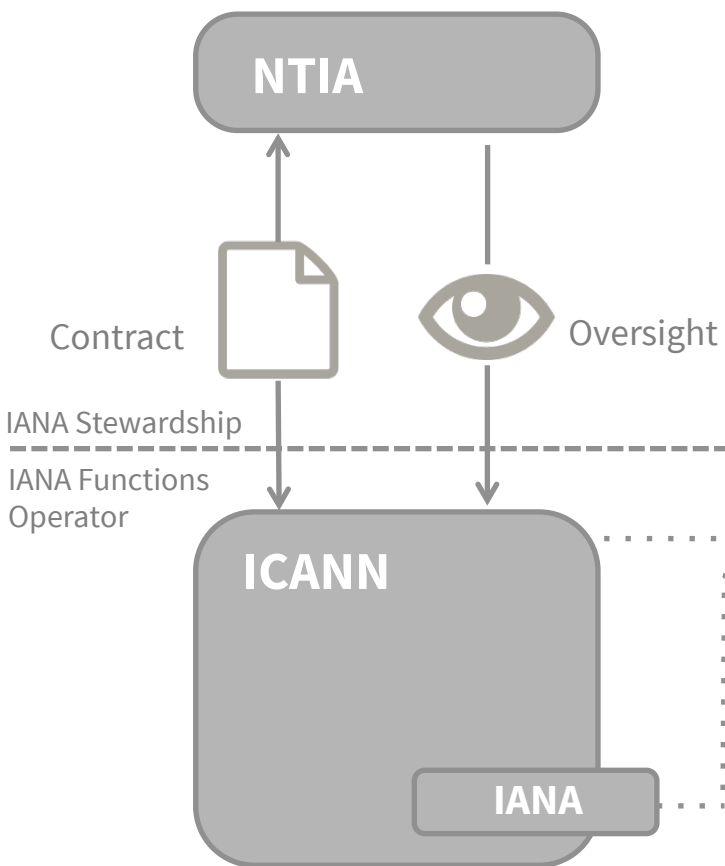

Post Transition

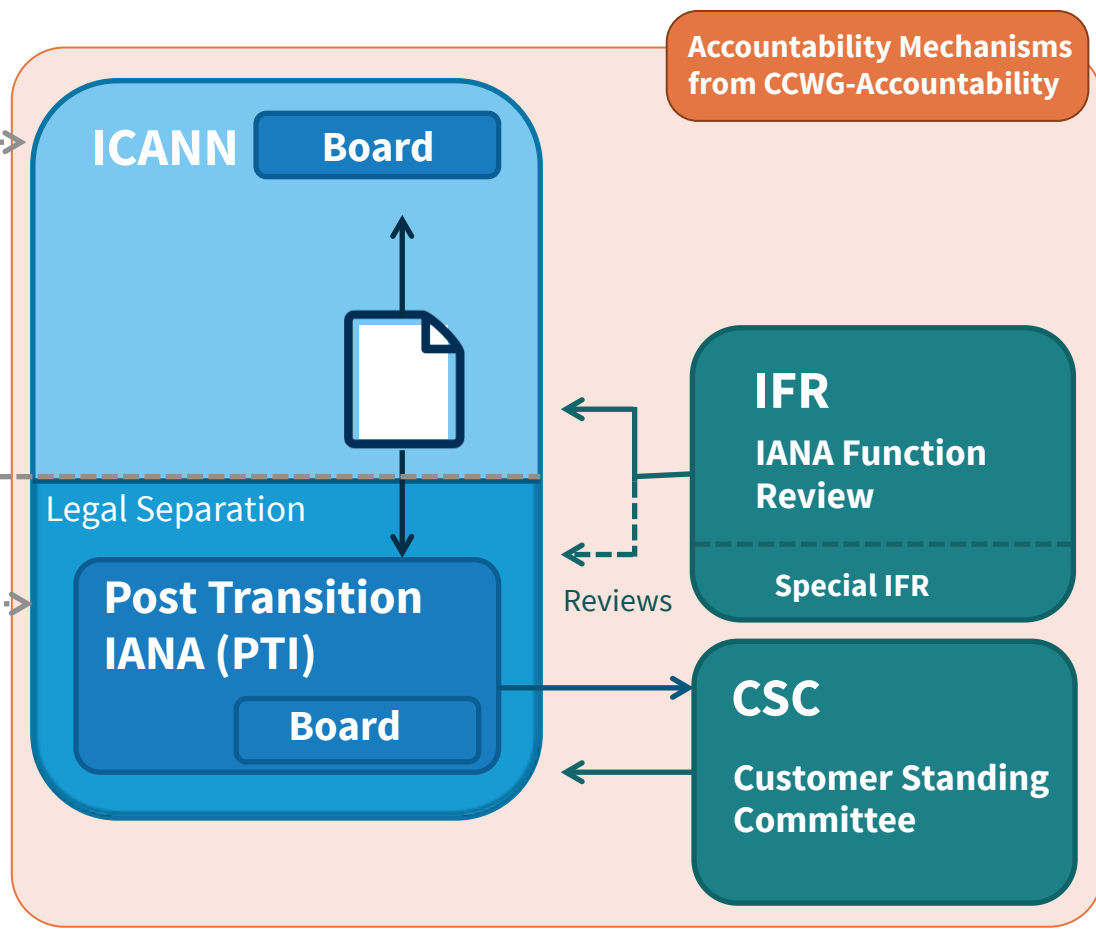

Post Transition IANA (PTI)

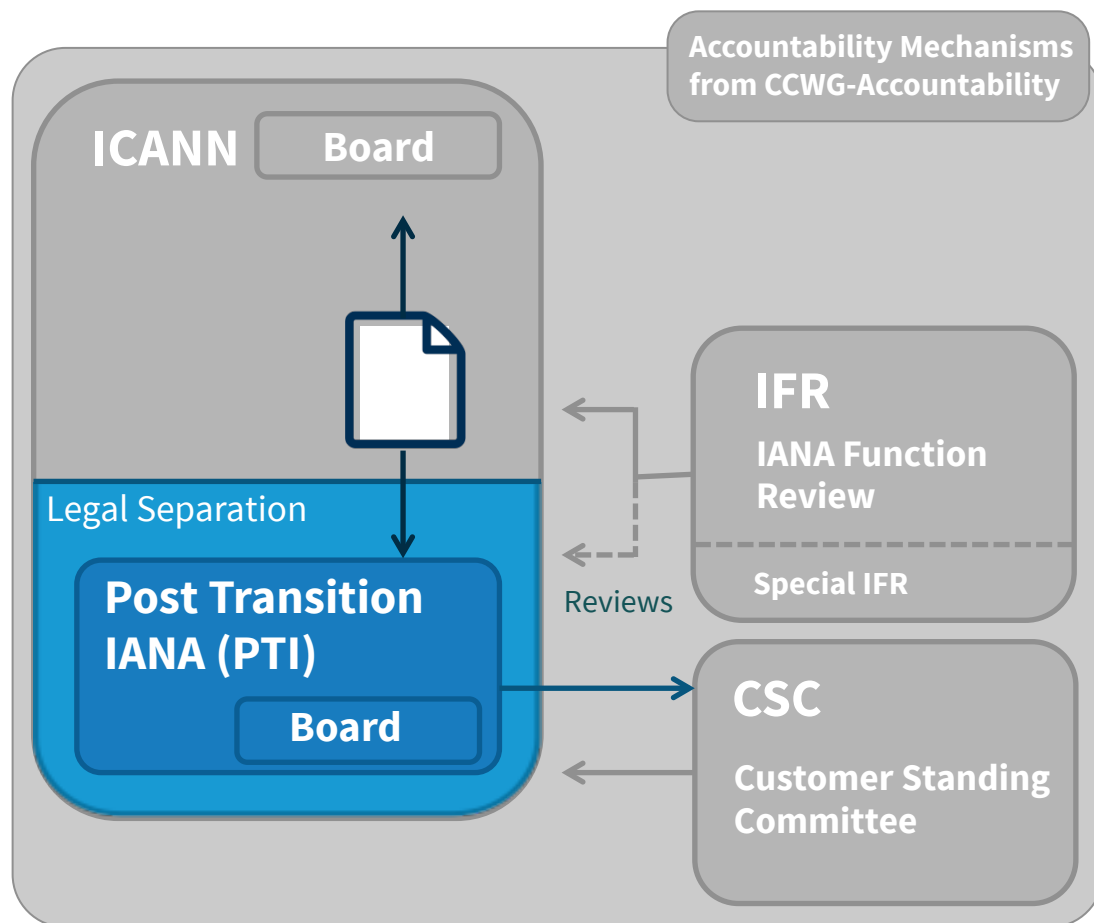

PTI Composition:

- 1 - ICANN Executive responsible for PTI
- 1 - The ICANN CTO
- 1 - IANA Managing Director
- 2 - Independent Directors

Customer Standing Committee (CSC)

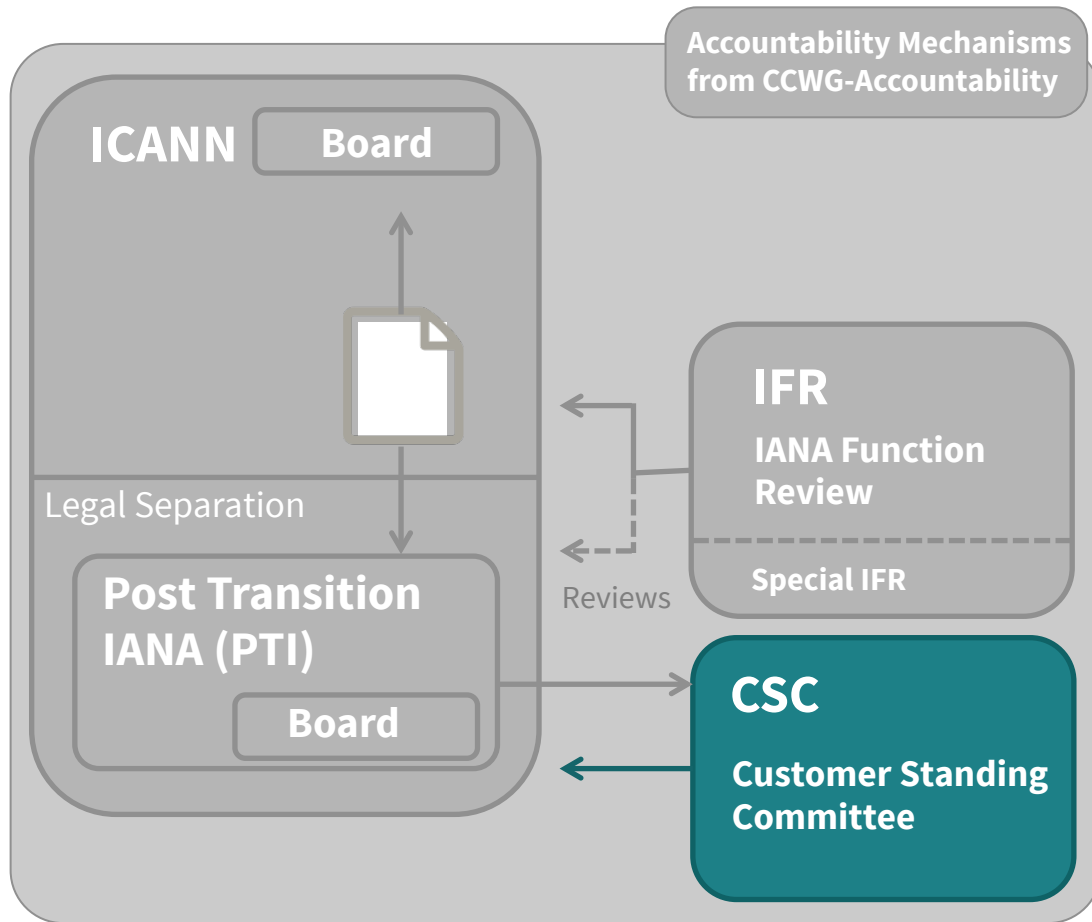

CSC Composition:

- 2 gTLD registry operators
- 2 ccTLD registry operators
- 1 additional TLD representative (non-gTLD and non-ccTLD)
- 1 Liaison from IANA
- 1 Liaison each from each ICANN Supporting Organization & Advisory Committee (total of 5)

IANA Function Review (IFR)

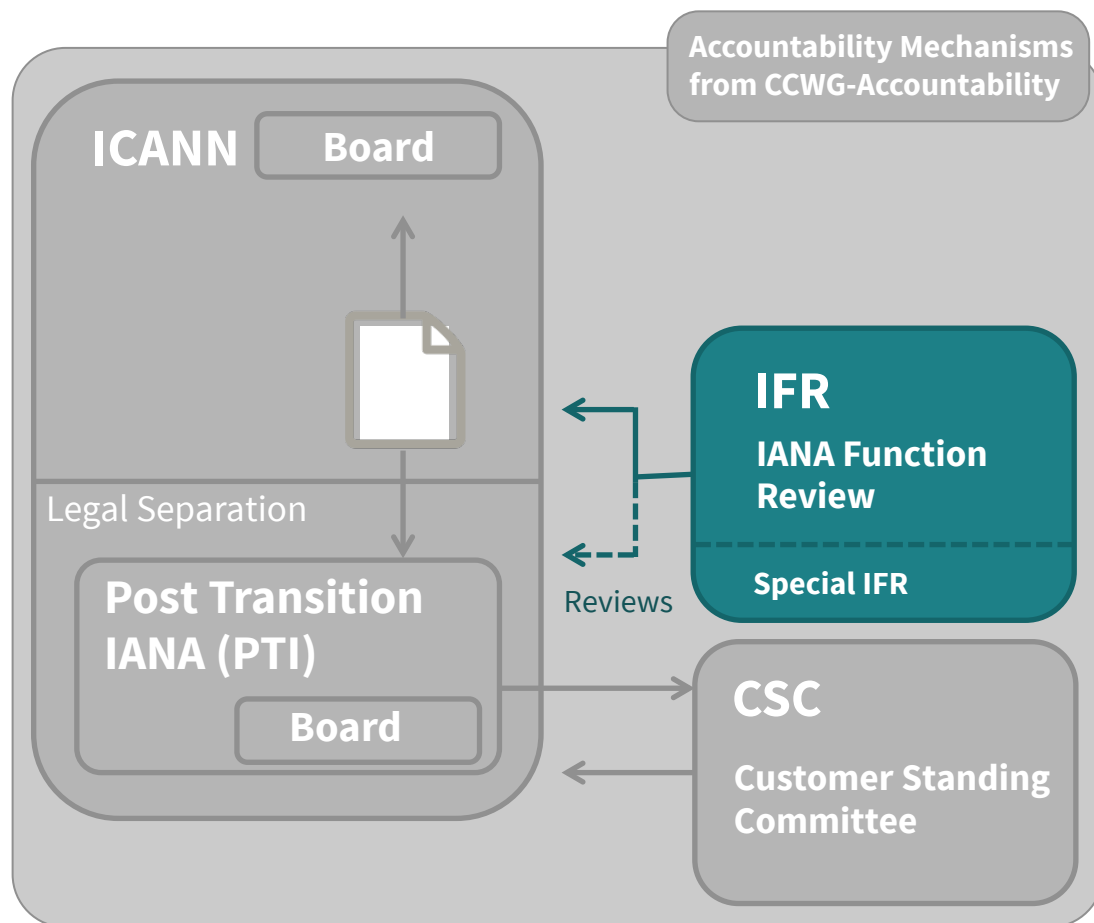

IFR Composition:

- 2 – ccNSO
- 1 - ccTLDs (non-ccNSO)
- 2 - Registry Stakeholder Group (RySG)
- 1 - Registrar Stakeholder Group (RsSG)
- 1 - Commercial Stakeholder Group (CSG)
- 1 – Non Commercial Stakeholder Group (NCSG)
- 1 - Government Advisory Committee (GAC)
- 1 - Security and Stability Advisory Committee (SSAC)
- 1 - Root Server Operators Advisory Committee (RSSAC)
- 1 - At-Large Advisory Committee (ALAC)
- 1 - CSC Liaison
- 1 – PTI point of contact (not a member of the IFRT)

A world map where the continents are defined by a complex network of white dots and thin white lines, resembling a social or data network. The background is a solid teal color. The text 'CCWG-Accountability' is centered over the map in white.

CCWG-Accountability

Goals and Requirements

Goal:

Deliver proposals that would enhance ICANN's accountability towards all stakeholders.

The CCWG-Accountability has two Work Streams:



Work Stream 1

Focused on mechanisms enhancing ICANN-Accountability that must be in place or committed to within the time frame of the IANA Stewardship Transition



Work Stream 2

Focused on addressing accountability topics for which a timeline for developing solutions and full implementation may extend beyond the IANA Stewardship Transition

Statistics and Diversity of the CCWG

 **26**
Members

 **120**
Participants

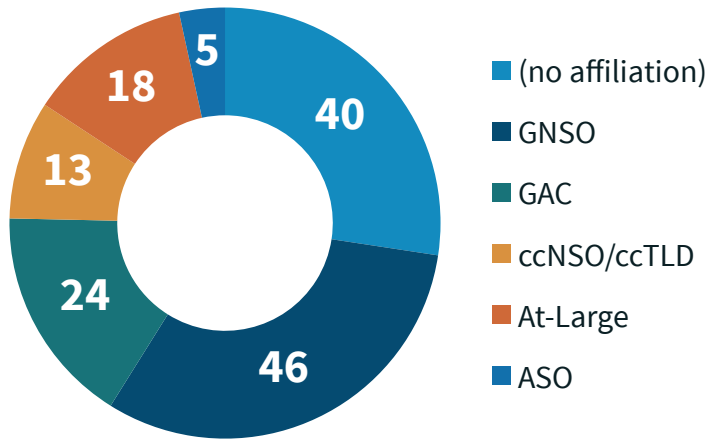

81
Calls/Meetings



4,699
Volunteer Hours



4,663
Mailing List
Messages

Building Blocks



Empowered Community

Refers to the powers that allow the community i.e. the people to take action should ICANN breach the principles



ICANN Board

Represents the executive entity the community may act against, as appropriate

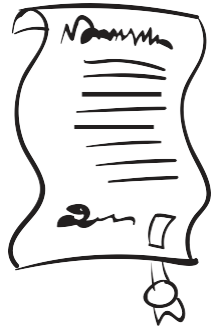

Principles Form the Mission

Guarantees and core values of the organization i.e the Constitution

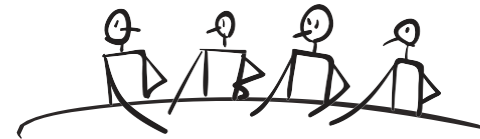

Independent Review Mechanisms

i.e. the judiciary, confers the power to review and provide redress, as needed

Pre-Transition

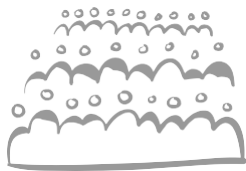

Community

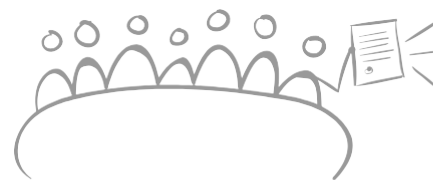

Board

BUDGET
STRAT/OPS PLANS
BYLAWS

Principles



**Independent
Appeals
Mechanism**



IRP

Post-Transition: Empowered Community



Principles

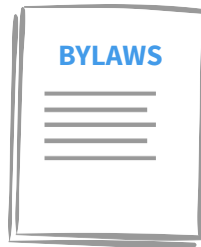

Independent Appeals Mechanism



Post-Transition: Community Powers

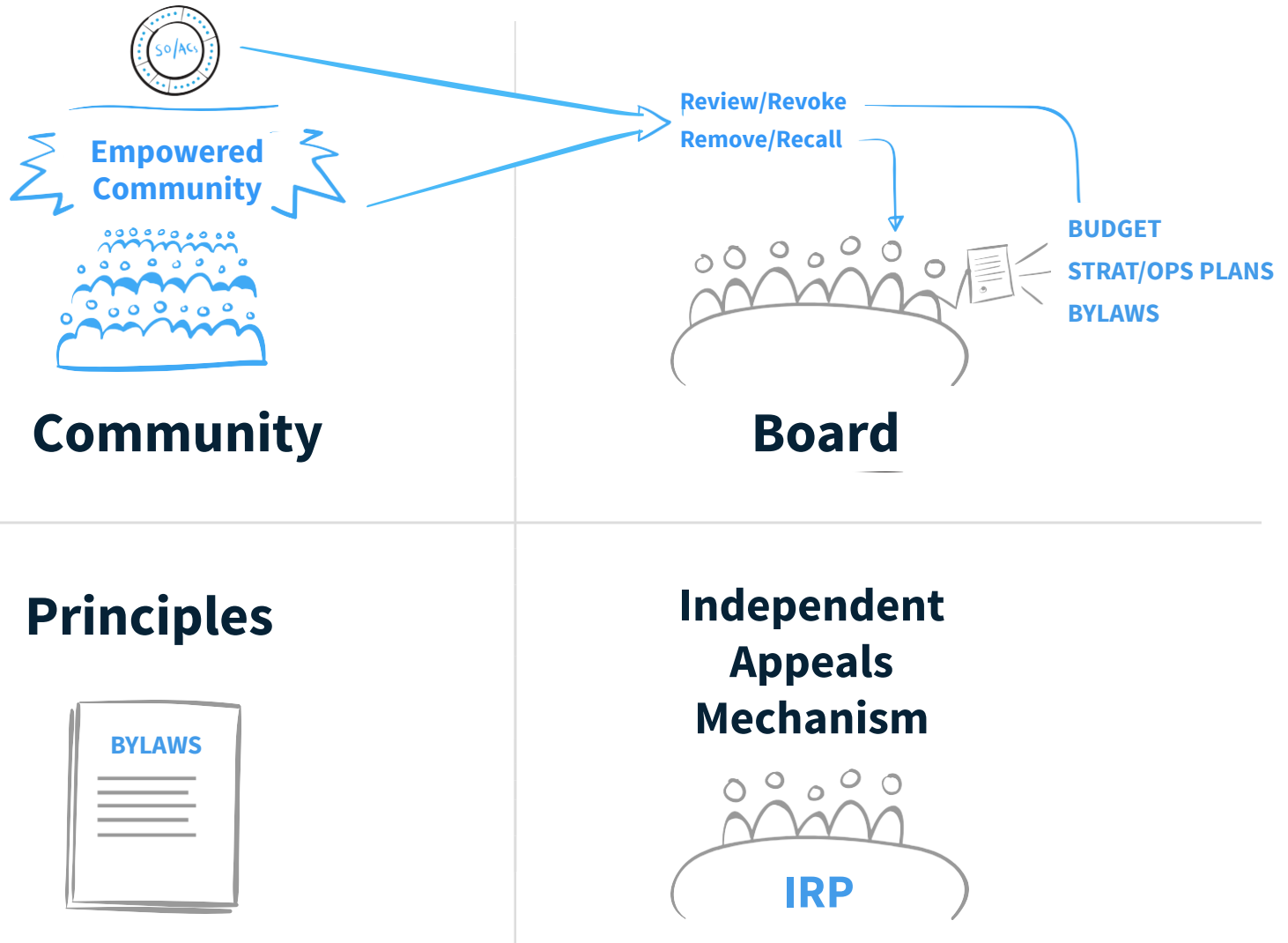

Post-Transition: Extra Bylaws & Fundamental Bylaws

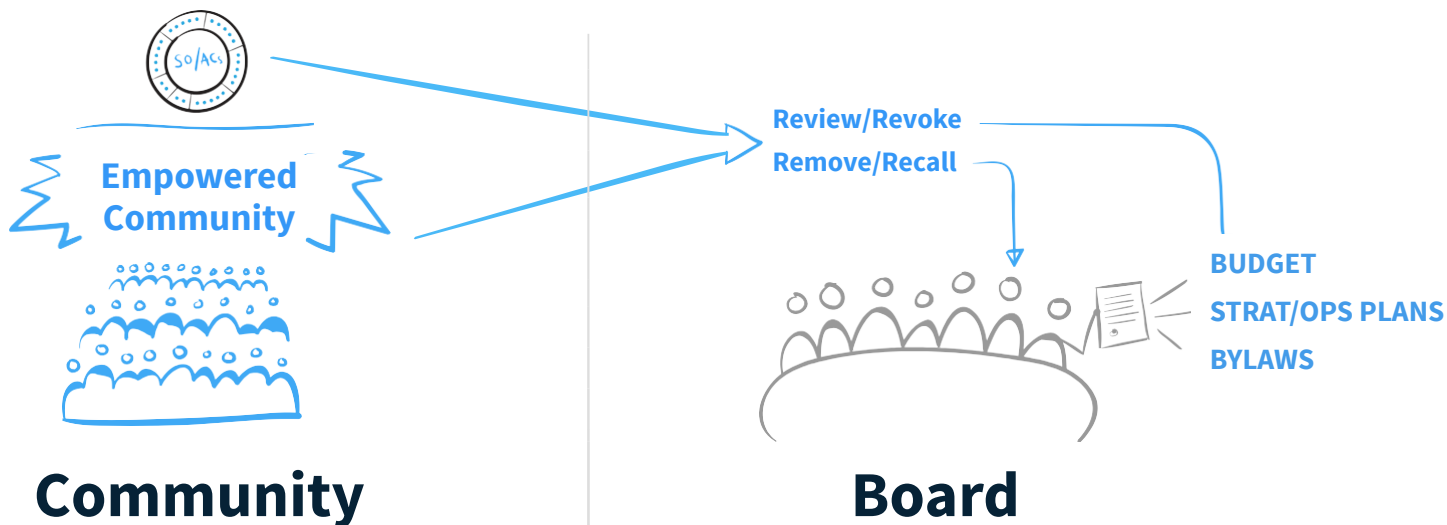

Principles

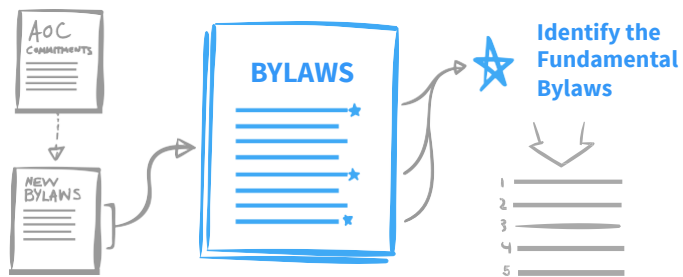

Independent Appeals Mechanism



Post-Transition: Enhanced IRP

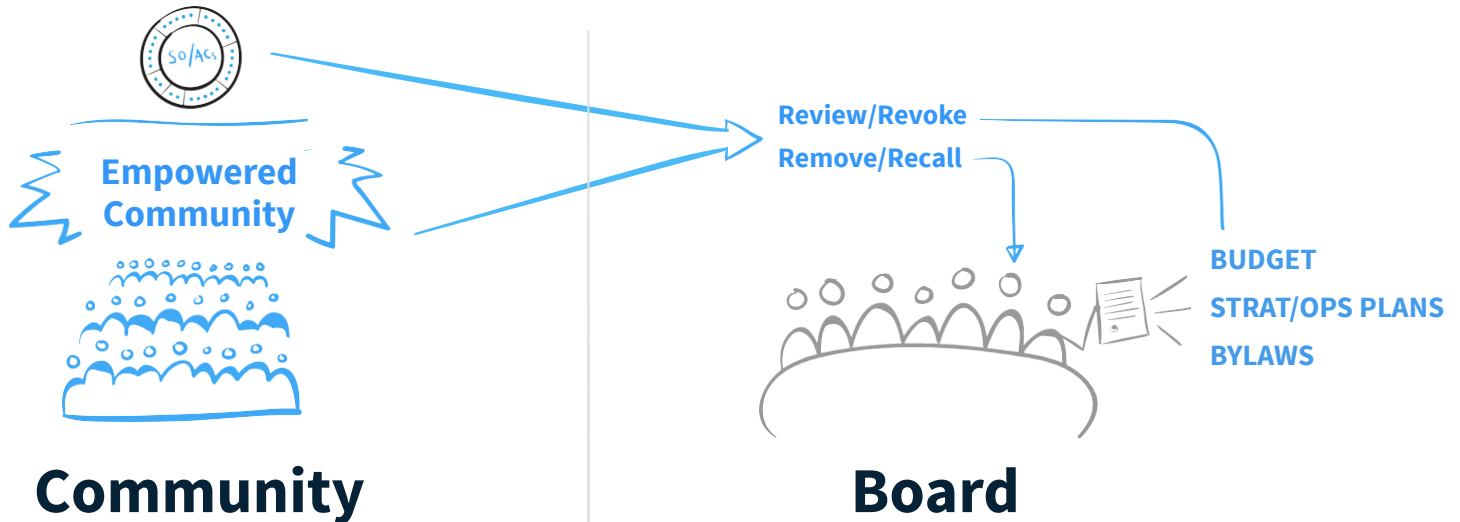

Principles

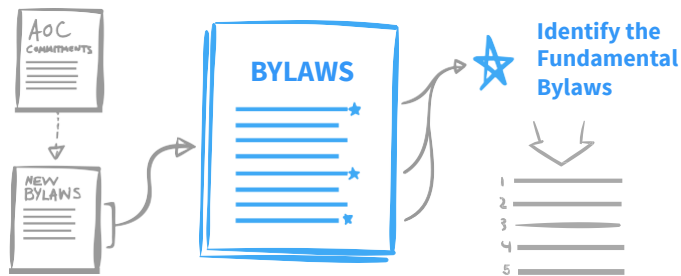

Independent Appeals Mechanism

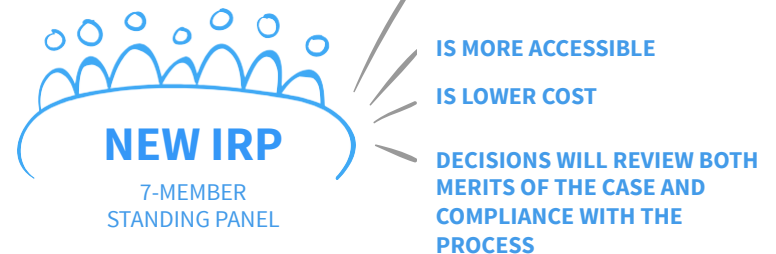

SO/AC Membership Model

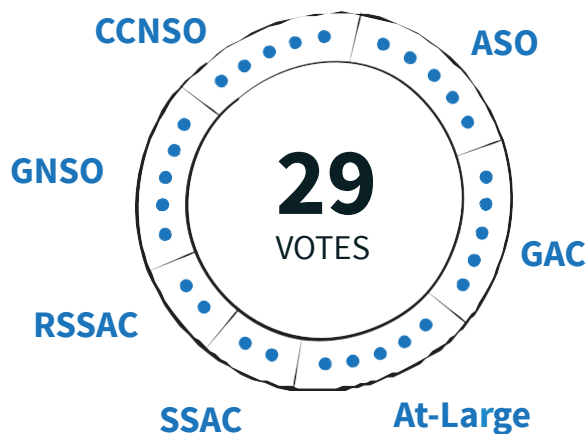
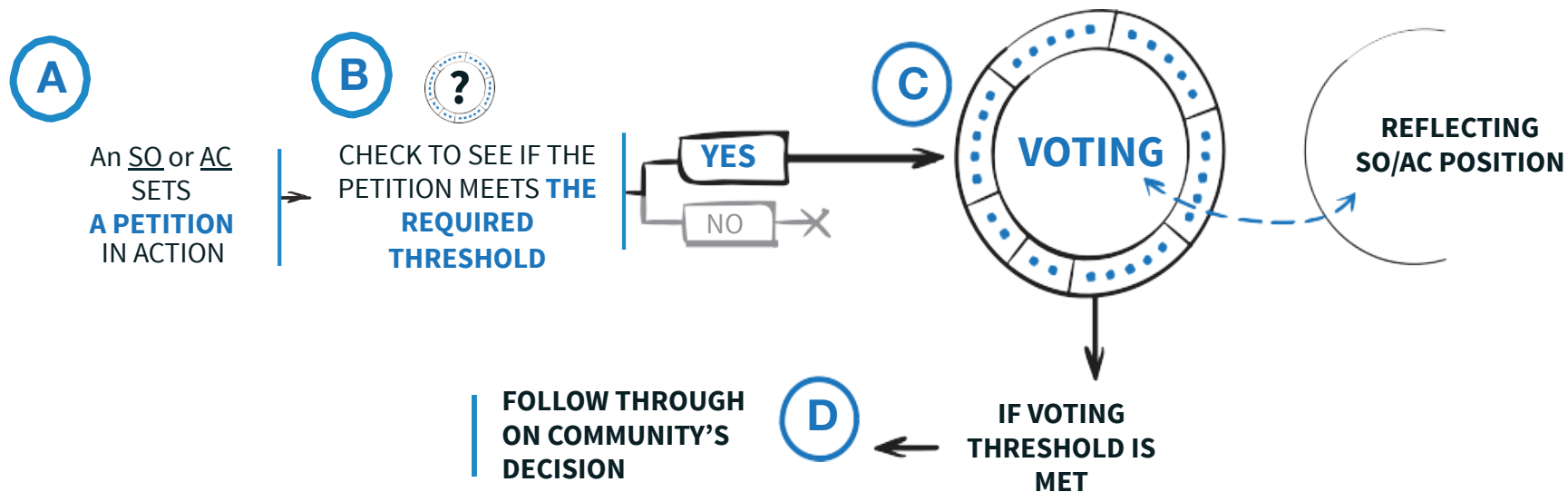

Influence in the Community Mechanism

Each SO and AC has a number of "votes" in the community mechanism, deciding on the powers established for the community

Public Comment Review



Recommendations that received strong support, near consensus

- Overall architecture (4 building blocks)
- Principle of Fundamental Bylaws
- A clearer definition of ICANN's Purpose and Mission
- Incorporation of AoC Reviews into the Bylaws



Recommendations that require further explanation, clarification

- Independent Review Process (IRP)



New Issues and Concerns

- Staff and management accountability (corporate culture of accountability)
- Community accountability
- Diversity
- Membership model and legal enforceability

A world map where the continents are defined by a complex network of white dots and thin white lines. The dots vary in size, and the lines connect them to form a web-like structure that outlines the major landmasses. The background is a solid, dark blue color.

Townhall Discussion

Post-Transition Structure

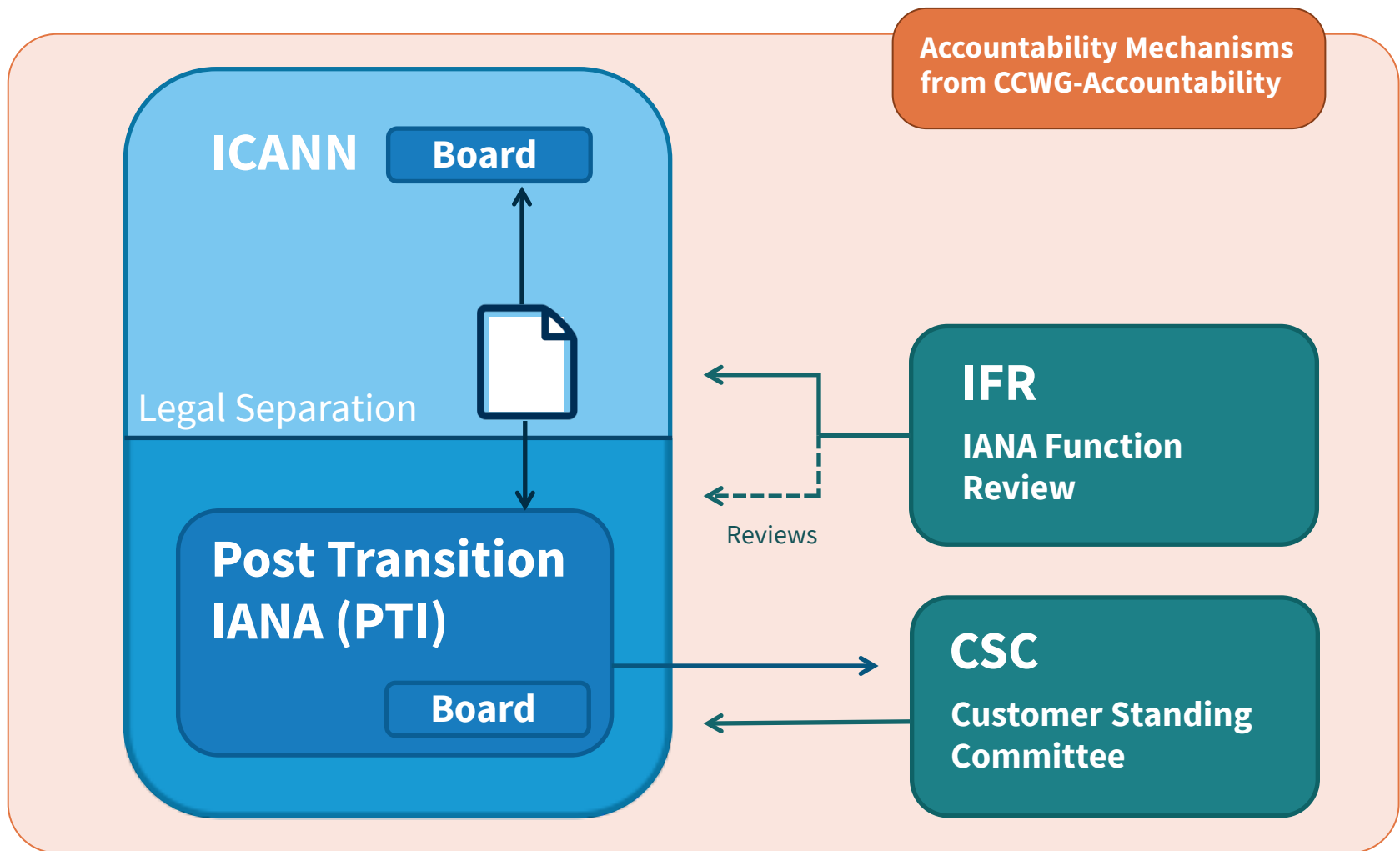

Linkage & Coordination with CCWG-Accountability

1

ICANN Budget

Community rights regarding development and consideration

4

CSC

Incorporated into the bylaws

2

ICANN Board

Community rights, specifically to appoint/remove members, recall entire Board

5

Independent Review Panel

Should be made applicable to IANA Functions and accessible by TLD managers

3

IANA Function Review

Incorporated into the bylaws

6

Fundamental bylaws

All foregoing mechanisms are to be provided for in the bylaws as “fundamental bylaws”

The CWG-Stewardship’s proposal is expressly conditioned upon the outcomes of the CCWG-Accountability.