

# CWG-Stewardship

Cross Community Working Group to Develop an IANA Stewardship Transition Proposal on Naming Related Functions

## Towards a Final Proposal

April 23, 2015 • v3.0

# CWG-Stewardship: Part of a Process

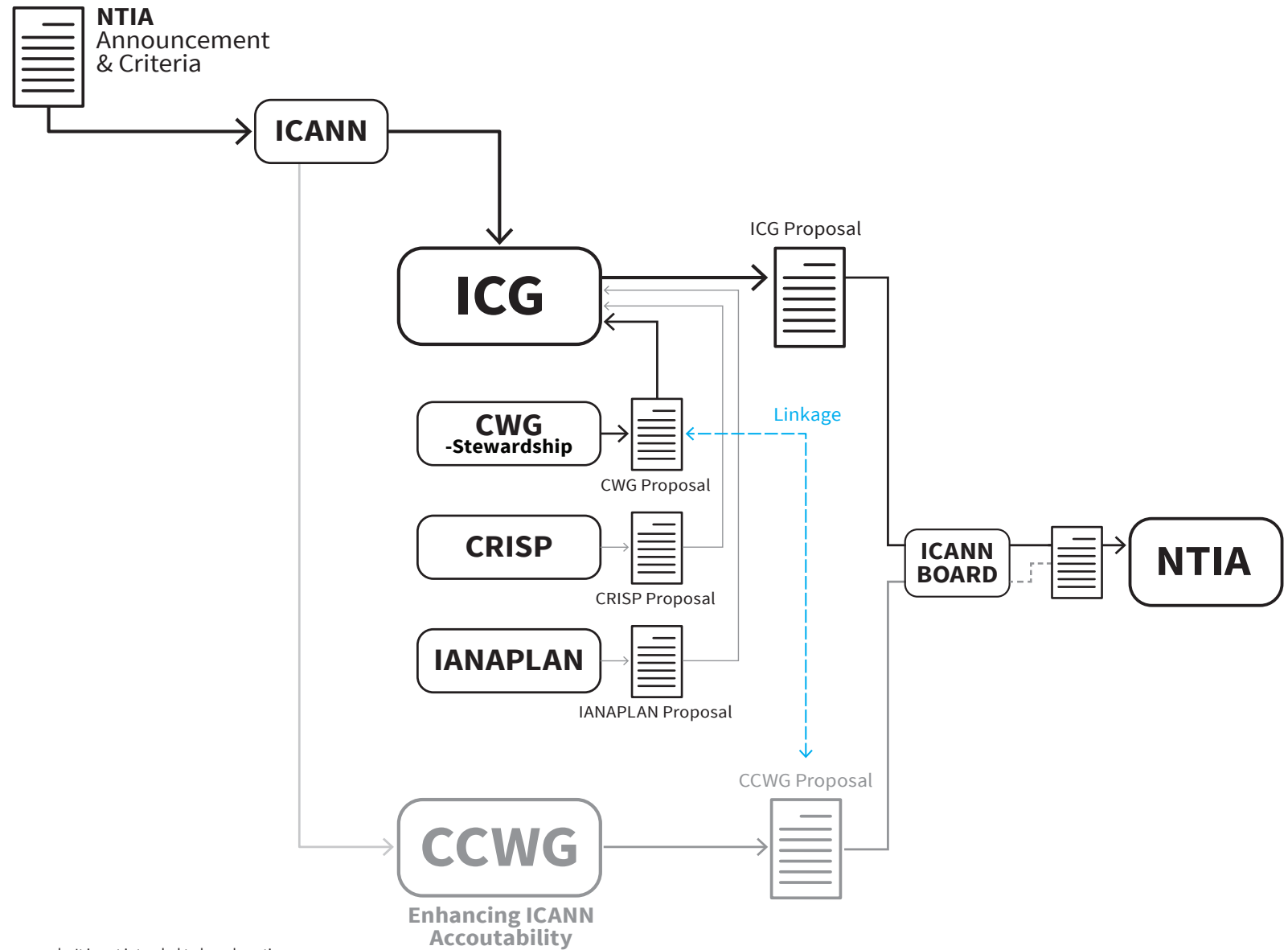

Note: the information on this page is for illustrative purposes only. It is not intended to be exhaustive.

# CWG-Stewardship: **Goal & Scope**

April 23, 2015 • v3.0

## The Goal of CWG-Stewardship

**Produce a consolidated transition proposal for the elements of the IANA Functions relating to the Domain Name System.**

The proposal must meet the needs of:

- The naming community in general
- All of the CWG-Stewardships' chartering organizations (ccNSO, SSAC, GNSO, ALAC, GAC)
- Direct consumers of IANA naming services including gTLDs and ccTLDs

## The Scope of CWG-Stewardship

Based on a summary and description of the IANA Functions drawn from the NTIA's statement of work for that IANA Contract, IANA Functions Operator performs 11 functions.

**The CWG-Stewardship is focused on 2-9 and 11**

(but may also comment on 1 or 10).

1. Coordinates the assignment of technical protocol parameters including the management of the Address and Routing Parameter Area (ARPA) TLD;
2. Performs administrative functions associated with root zone management;
3. Manages root zone file change requests;
4. Manages "WHOIS" change requests and the WHOIS database;
5. Implements changes in the assignment of Country Code Top Level-Domains (ccTLDs) in accordance with established policy;
6. Implements decisions related to the delegation and redelegation of Generic Top Level Domain (gTLD) in accordance with ICANN policy;
7. Undertakes projects to increase root zone automation;
8. Manages Root Domain Name System Security Extensions (DNSSEC) keys;
9. Provides a Customer Service Complaint Resolution Process (CSCR);
10. Allocates Internet numbering resources; and
11. Performs other services (operate the .INTTLD, implement modifications in

# CWG-Stewardship: Our Timeline • Progress to Date

April 23, 2015 • v3.0

Note: the information on this page is for illustrative purposes only. It is not intended to be exhaustive.

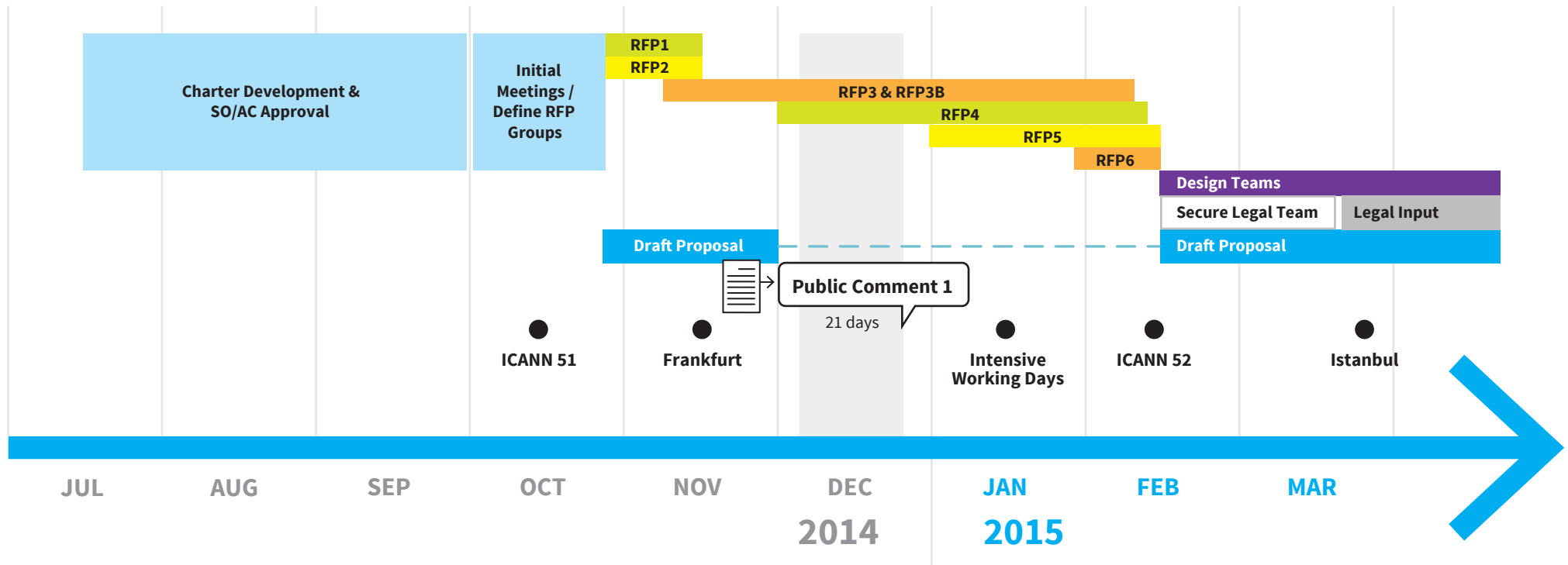
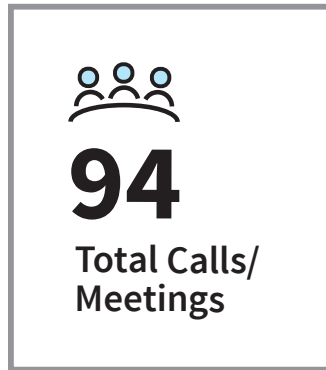

# CWG-Stewardship: Proposal Development Overview

April 23, 2015 • v3.0

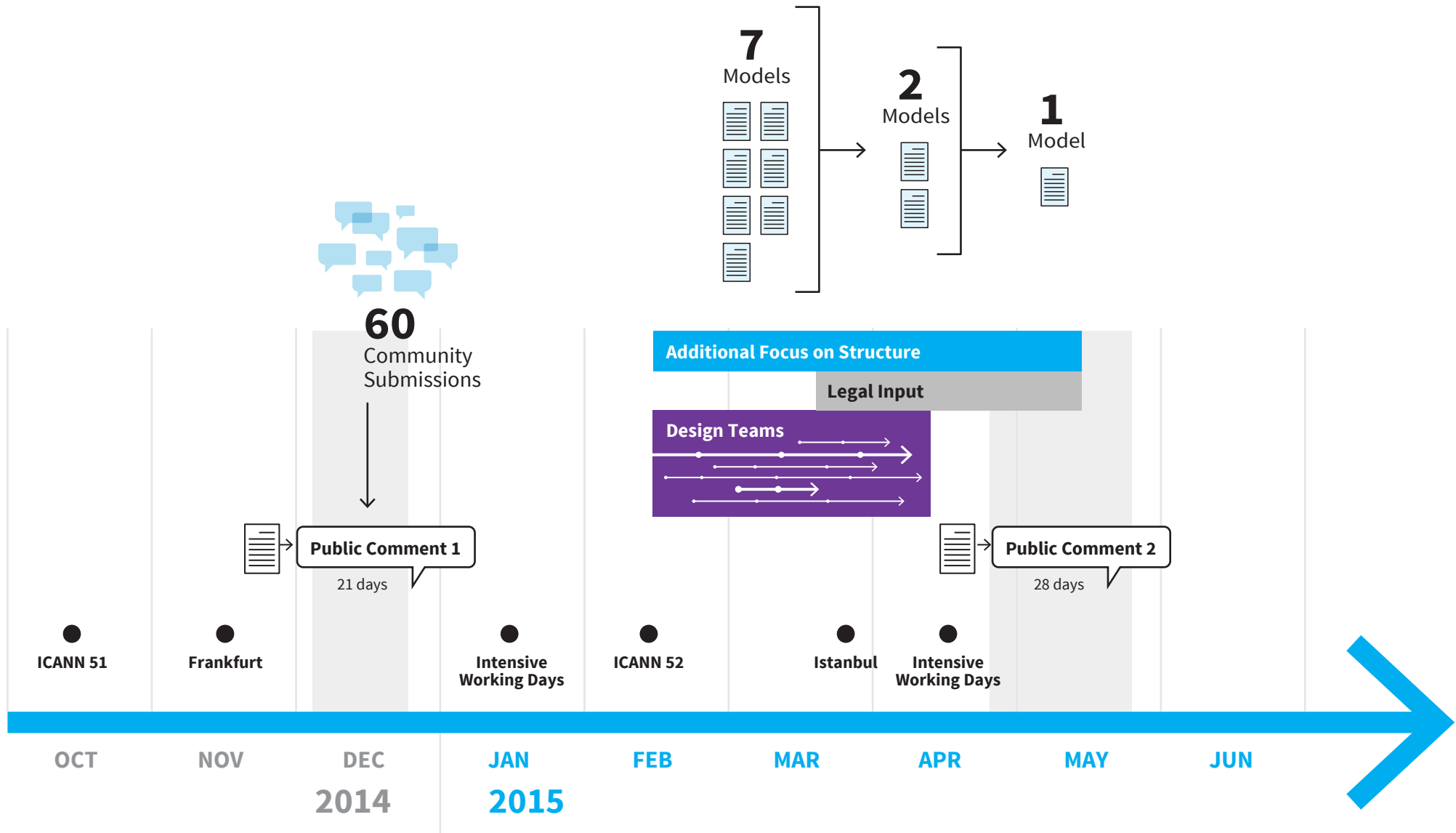

# CWG-Stewardship: Linkage & Coordination with the CCWG-Accountability

April 23, 2015 • v3.0

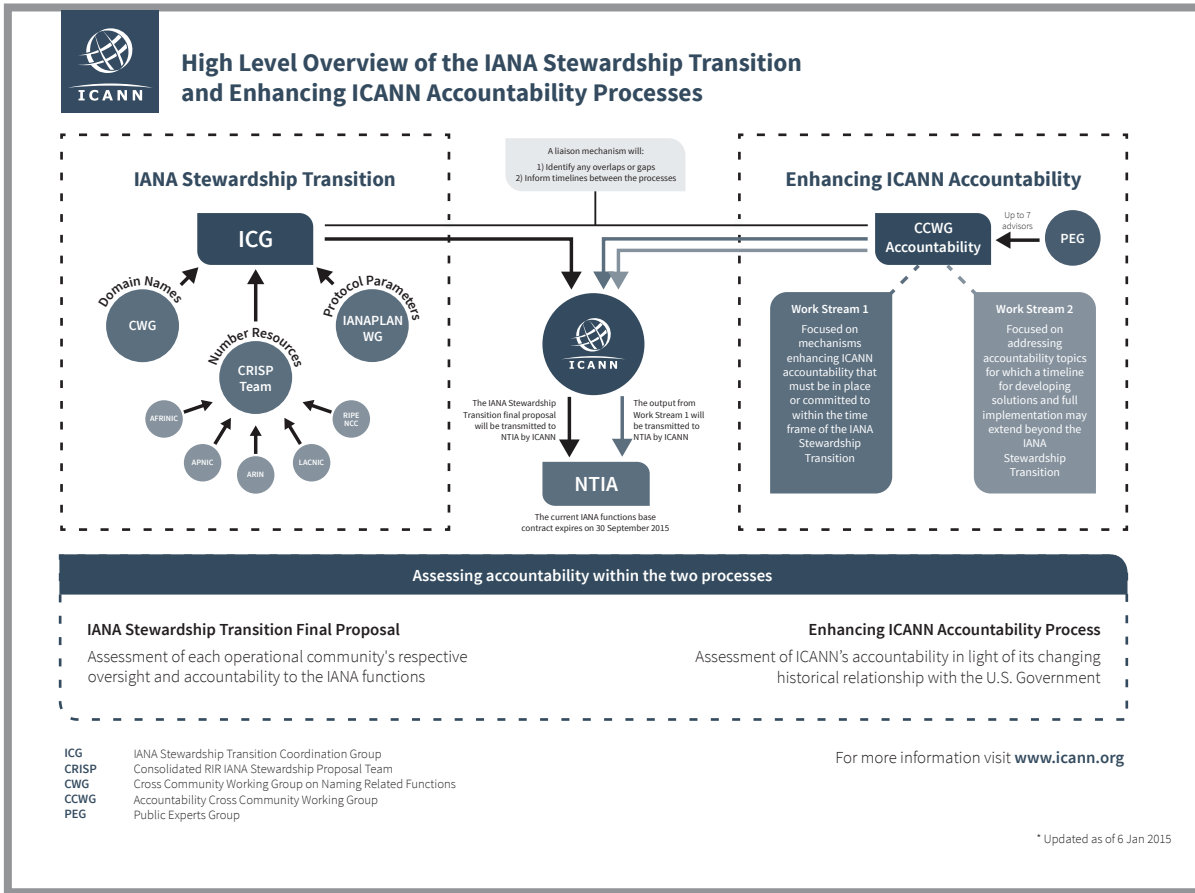

The Chairs recognize that continued and close engagement with the CCWG-Accountability is essential to the elaboration of a complete proposal, since aspects of the CWG-Stewardship proposal will be conditional on the output of the CCWG-Accountability.

What follows is a summary of the CWG-Stewardship's input, which was formally submitted to the CCWG-Accountability in a letter on 15 April, available here: <https://community.icann.org/x/DiknAw>.

continued on next page >>

Download full graphic here: <https://www.icann.org/en/system/files/files/iana-stewardship-accountability-07jan15-en.pdf>

# CWG-Stewardship: Linkage & Coordination with the CCWG-Accountability

April 23, 2015 • v3.0

## ICANN Budget

*(in particular, relating to a confidence vote option)*

The CWG-Stewardship supports the CCWG's proposal(s) for a budget veto tool, where the community has the option to reject an ICANN budget and send it back for further consideration and revision;

The CWG-Stewardship recommends as a part of its transition plan:

1. The IANA Function's comprehensive costs should be transparent for any future state of the IANA Function
2. Future FY ICANN Operating Plans & Budgets (including FY16 if possible) include at a minimum itemization of all IANA operations costs down to the project level and below as needed to the project level and below as needed

## Community Empowerment Mechanisms

*(in particular, relating to a confidence vote option)*

The CWG-Stewardship will be relying on the community empowerment and accountability mechanisms that the CCWG-Accountability is currently considering and developing being in place at the time of the stewardship transition.

- The ability to review ICANN Board decisions relating to periodic or special reviews of the IANA Function
- The ability to approve or reject board decisions on the IANA Function Review as well as the related creation of a stakeholder community/ member group

## Review and Redress Mechanisms

*(in particular, relating to a 'fundamental bylaw' mechanism)*

The CWG-Stewardship recommends regular reviews of the IANA Function take place.

- Reviews should happen every 5 years, and should operate in a manner analogous to an AoC review
- Reviews should be incorporated into ICANN's bylaw as part of a 'fundamental bylaw'
- A special review may be initiated following the CSC raising concerns with the GNSO and/or the ccNSO or by concerns raised by TLDs directly with the ccNSO or the GNSO

## Appeal Mechanisms

*(especially with regard to ccTLD related issues)*

The CWG-Stewardship notes that ccTLDs may decide to develop their own appeals mechanism regarding re/delegation at a later date (post-transition), as such the CWG-Stewardship recommends:

- The CCWG-Accountability should not develop appeal mechanism(s) related to ccTLD delegation/ re-delegation issues
- The CCWG-Accountability should develop appeal mechanism(s) related to any other issues that may involve the IANA Function(s)

# CWG-Stewardship: Design Teams Status • End of High Intensity Meetings

14 APR

7

April 23, 2015 • v3.0

	Priority	Status	Proposed Status	Links/Dependencies	Deadline
<b>A</b> IANA Service Level Expectations	1	In Progress	Prov. Complete	C, M, N / D	17 April
<b>B</b> Delegations / Redelegations Appeal	1	Submitted*	Complete		10 April
<b>C</b> Customer Standing Committee	1	Submitted*	Prov. Complete	J, H, N / A, D, M	10 April
<b>D</b> Authorization Function	1	Complete	Complete	F	–
<b>E</b> SAC 69	1	Complete	Complete	Red Team	–
<b>F</b> Relationships NTIA/IANA/Root Zone Maintainer	1	In Progress	Prov. Complete	D	17 April
<b>G</b> IANA Intellectual Property Rights	2	To Be Started	Not Needed/ Covered Elsewhere		–
<b>H</b> .INT Operations	2	To Be Started	Not Needed/ Covered Elsewhere		–
<b>I</b> Competition policy and Conflicts of Interest	2	To Be Started	Not Needed/ Covered Elsewhere		–
<b>J</b> CSC/MRT confidentiality and conflicts of interest	2	To Be Started	Not Needed/ Covered Elsewhere		–
<b>K</b> OFAC Licensing	2	To Be Started	Not Needed/ Covered Elsewhere		–
<b>L</b> Framework for Transition to Successor IANA Operator	1	Submitted*	Complete		10 April
<b>M</b> Escalation Mechanisms	1	Submitted*	Prov. Complete	A, C, N	10 April
<b>N</b> Periodic Review of the IANA Functions	1	Submitted*	Prov. Complete	A, C, M	10 April
<b>O</b> IANA Budget <b>[NEW!]</b>	–	Submitted*	Complete		10 April
<b>●</b> Red Team	–	To Be Started	Not Needed/ Covered Elsewhere		10 April

\*Proposed content was submitted for review during high intensity meetings on 13-14 April



# CWG-Stewardship: Internal Accountability Model

April 23, 2015 • v3.0

## Current Contract

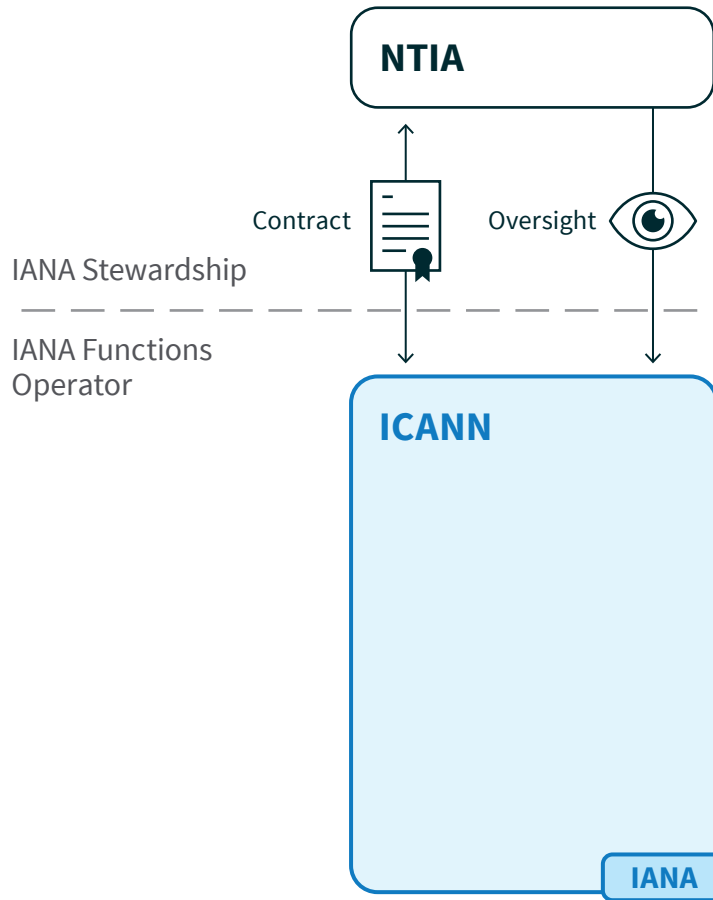

## Post Transition

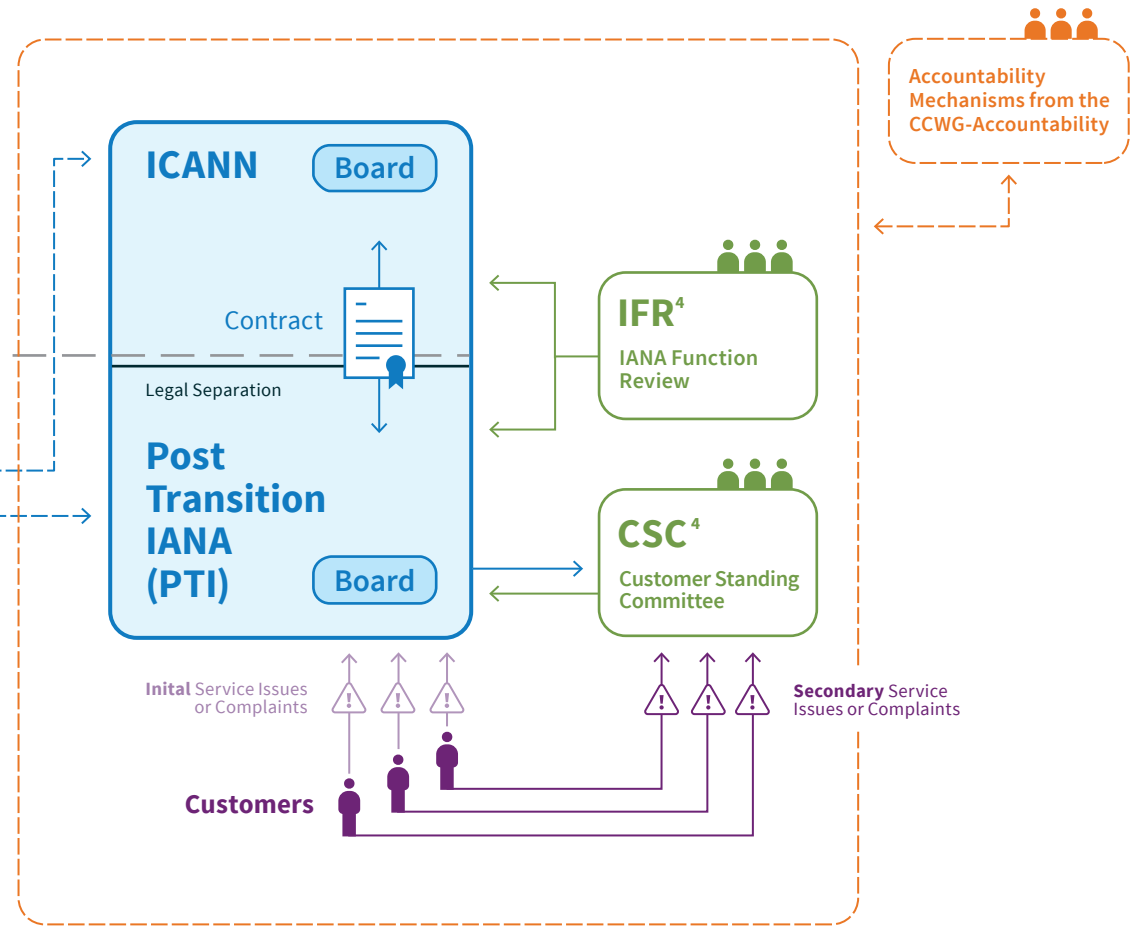

<sup>1</sup> The ultimate accountability mechanism is dependent on the work of the CCWG-Accountability.

<sup>4</sup> Group, But Not Necessarily a Legal Entity

# CWG-Stewardship: Our Timeline • The Road Ahead

April 23, 2015 • v3.0

Note: the information on this page is for illustrative purposes only. It is not intended to be exhaustive.

