



ICANN | 53 
Buenos Aires

21-25 JUNE 2015

CCWG-Accountability Update
Enhancing ICANN Accountability



Part of a Process

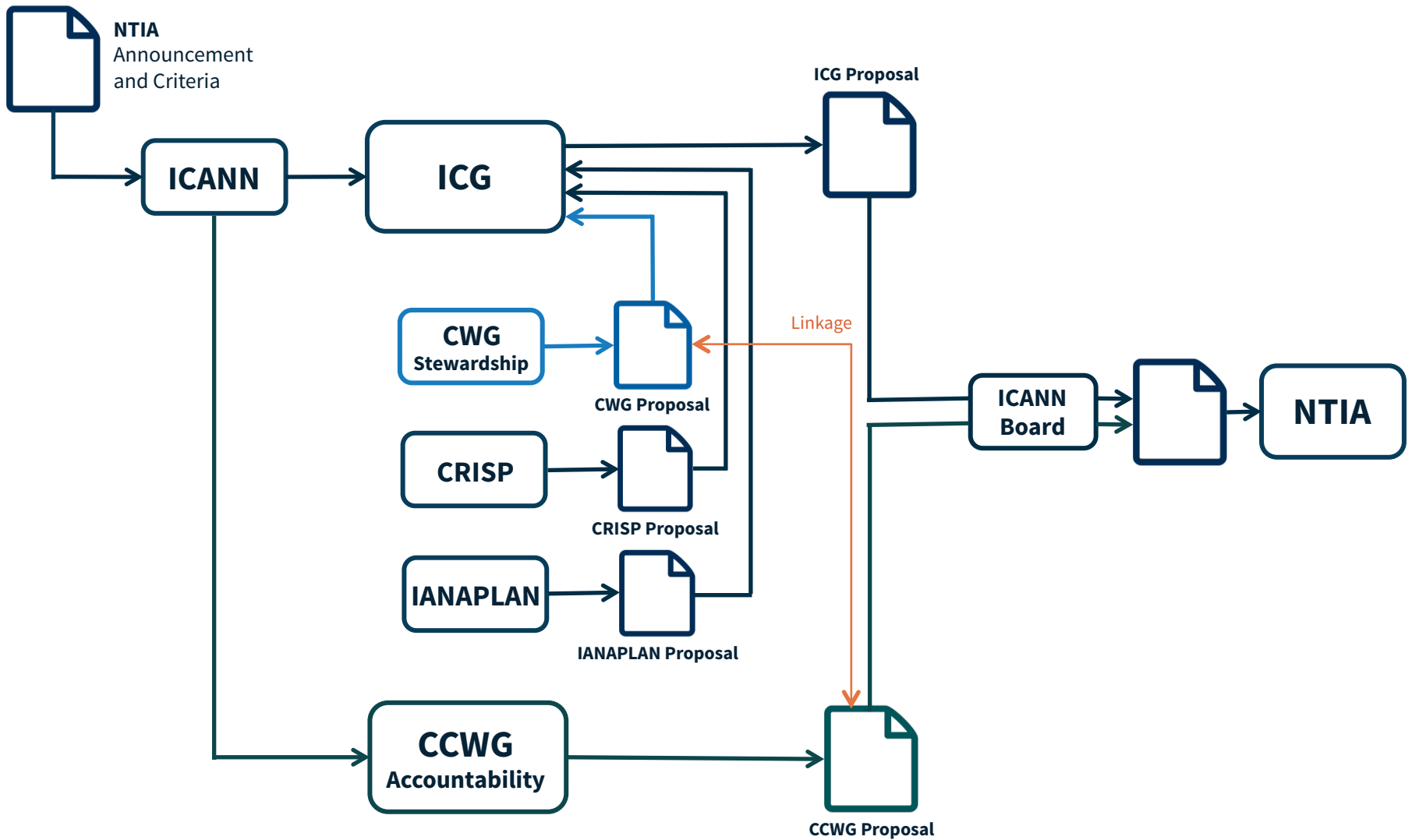

Goals and Requirements

Goal:

Deliver proposals that would enhance ICANN's accountability towards all stakeholders.

The CCWG-Accountability has two Work Streams:



Work Stream 1

Focused on mechanisms enhancing ICANN-Accountability that must be in place or committed to within the time frame of the IANA Stewardship Transition



Work Stream 2

Focused on addressing accountability topics for which a timeline for developing solutions and full implementation may extend beyond the IANA Stewardship Transition

Statistics and Diversity of the CCWG

26
Members

120
Participants

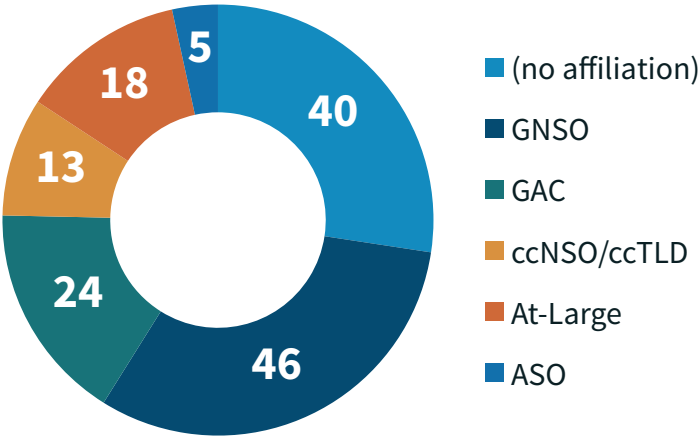

81
Calls/Meetings



4,699
Volunteer Hours



4,663
Mailing List Messages

Building Blocks



Empowered Community

Refers to the powers that allow the community i.e. the people to take action should ICANN breach the principles



ICANN Board

Represents the executive entity the community may act against, as appropriate

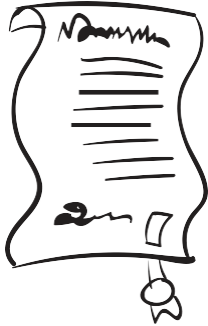

Principles Form the Mission

Guarantees and core values of the organization i.e the Constitution



Independent Review Mechanisms

i.e. the judiciary, confers the power to review and provide redress, as needed

Pre-Transition

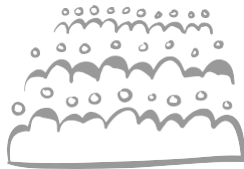

Community

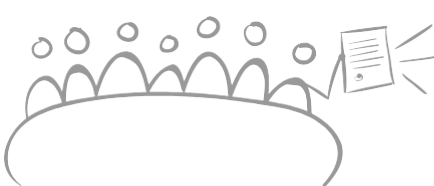

**BUDGET
STRAT/OPS
BYLAWS**

Board

Principles



**Independent
Appeals
Mechanism**



IRP

Post-Transition: Empowered Community



Principles



Independent
Appeals
Mechanism



Post-Transition: Community Powers

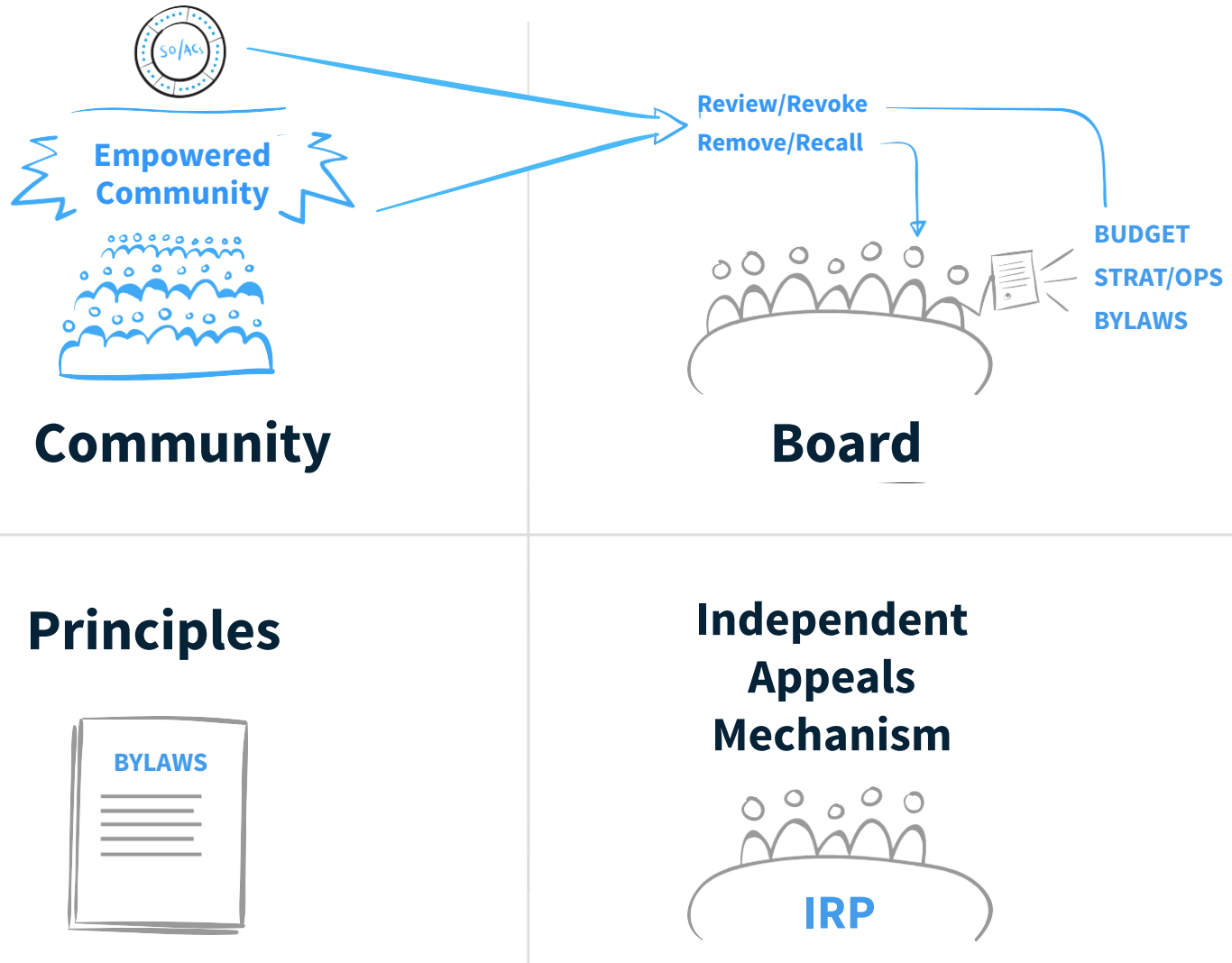

Post-Transition: Extra Bylaws & Fundamental Bylaws

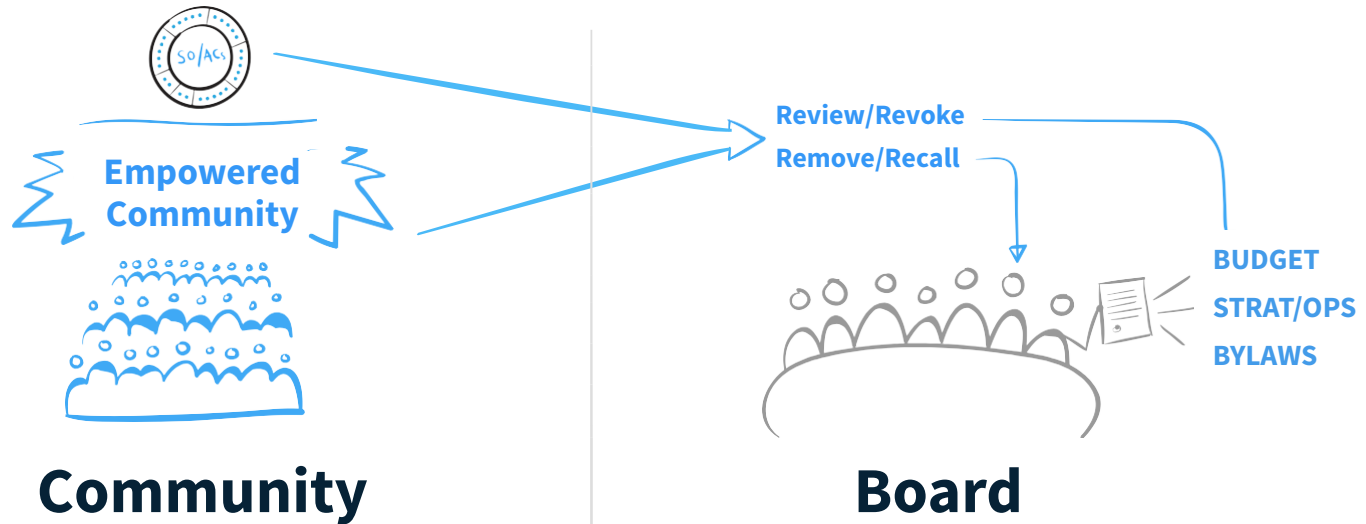

Principles

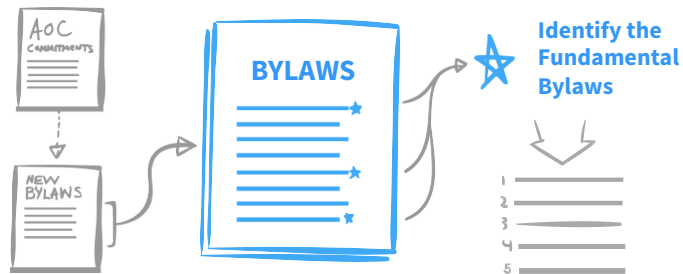

Independent Appeals Mechanism



Post-Transition: Enhanced IRP

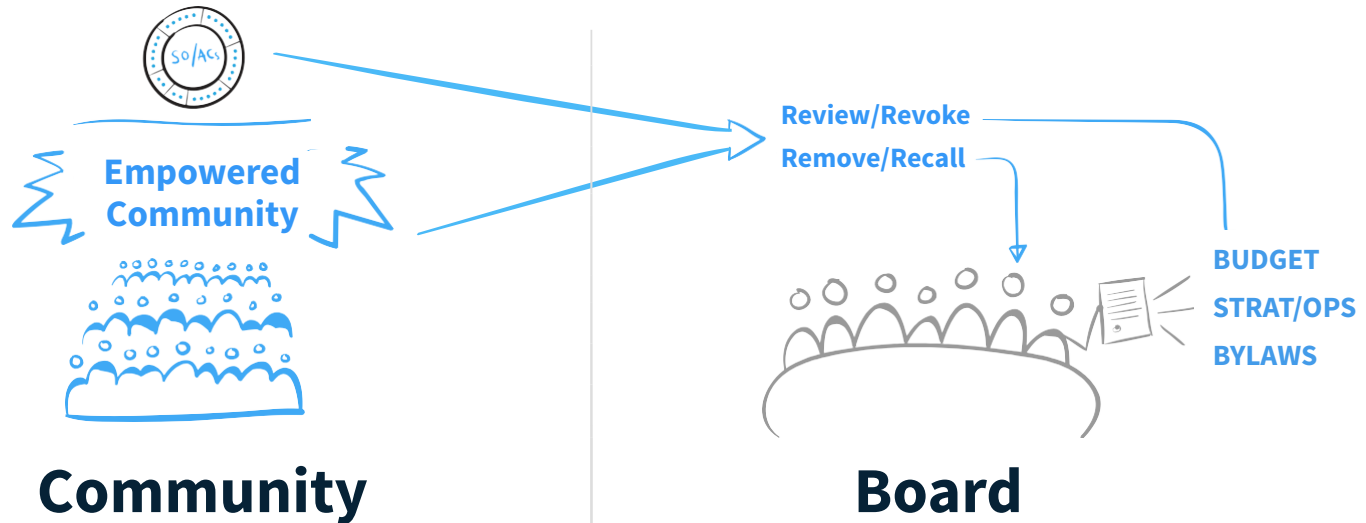

Principles

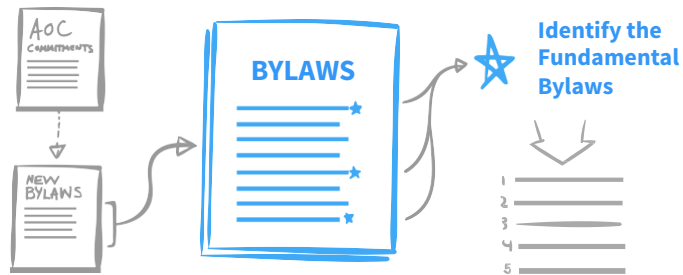

Independent Appeals Mechanism

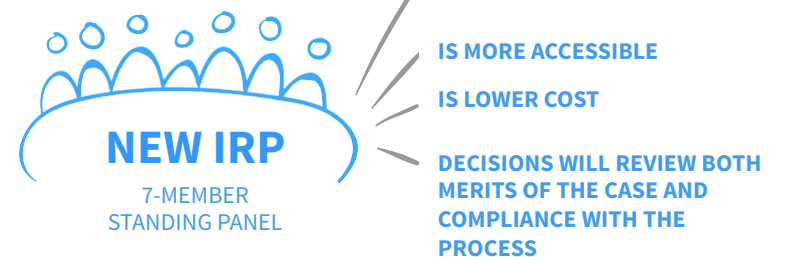

SO/AC Membership Model

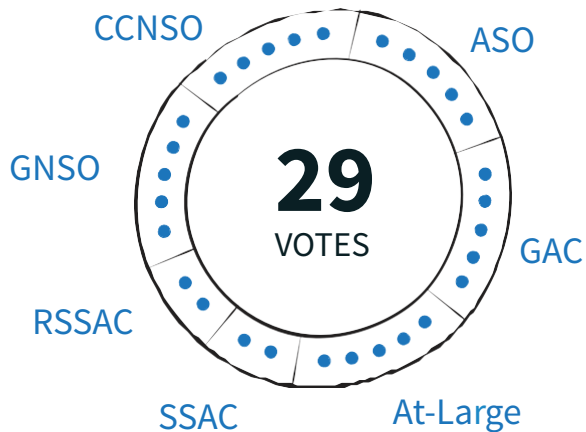
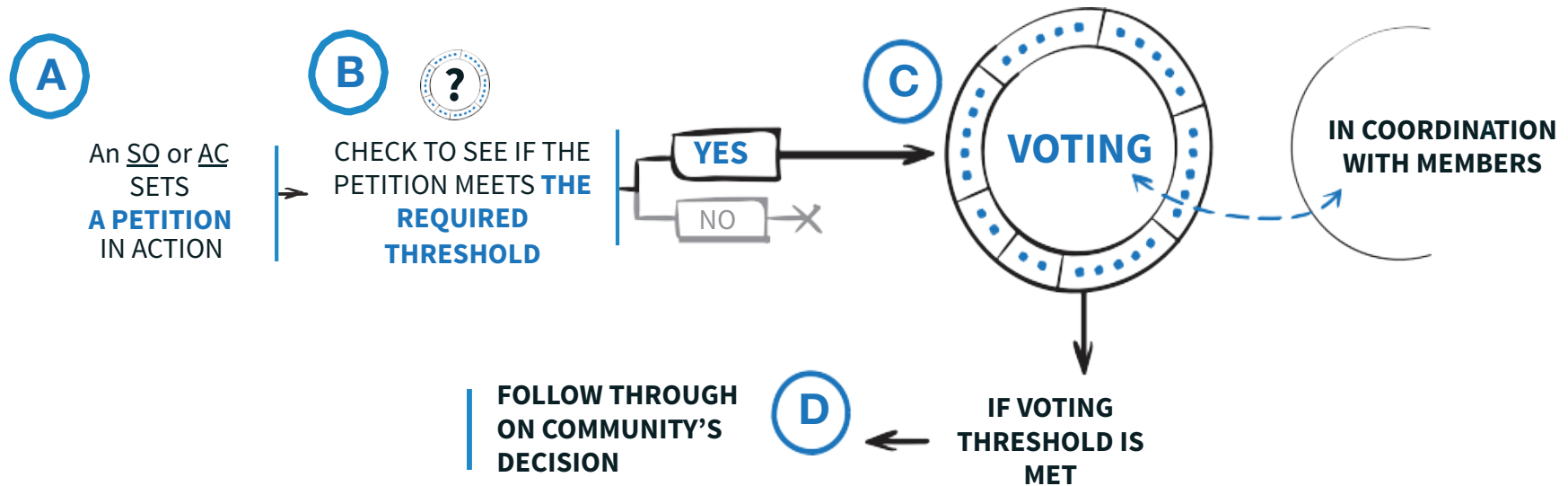

Influence in the Community Mechanism

Each SO and AC has a number of “votes” in the community mechanism, deciding on the powers established for the community

Developments from Face-to-Face Meeting



Drafting responses to public comments received

- ✓ Broad support for overall architecture (4 building blocks)
- ✓ Proposals would be improvement to current mechanisms
- ✓ Suggestion to look at accountability of community itself and accountability to all stakeholders
- ✓ Concerns expressed regarding implementation, complexity, risks, costs and legal implications
- ✓ Items considered as critical to CWG-Stewardship proposal received overall support



Community Empowerment Mechanism

- ✓ Various models were considered and commonalities acknowledged
- ✓ In process of refining a model: “Empowerment SO/AC model”
- ✓ “Empowerment SO/AC model” will give community comparable authority while not adding legal entities separate from SOs and ACs

Linkage & Coordination with CWG-Stewardship

1

ICANN Budget

Community rights regarding development and consideration

4

CSC

Incorporated into the bylaws

2

ICANN Board

Community rights, specifically to appoint/remove members, recall entire Board

5

Independent Review Panel

Should be made applicable to IANA Functions and accessible by TLD managers

3

IANA Function Review

Incorporated into the bylaws

6

Fundamental bylaws

All foregoing mechanisms are to be provided for in the bylaws as “fundamental bylaws”

The CWG-Stewardship’s proposal is expressly conditioned upon the outcomes of the CCWG-Accountability.

Timeline

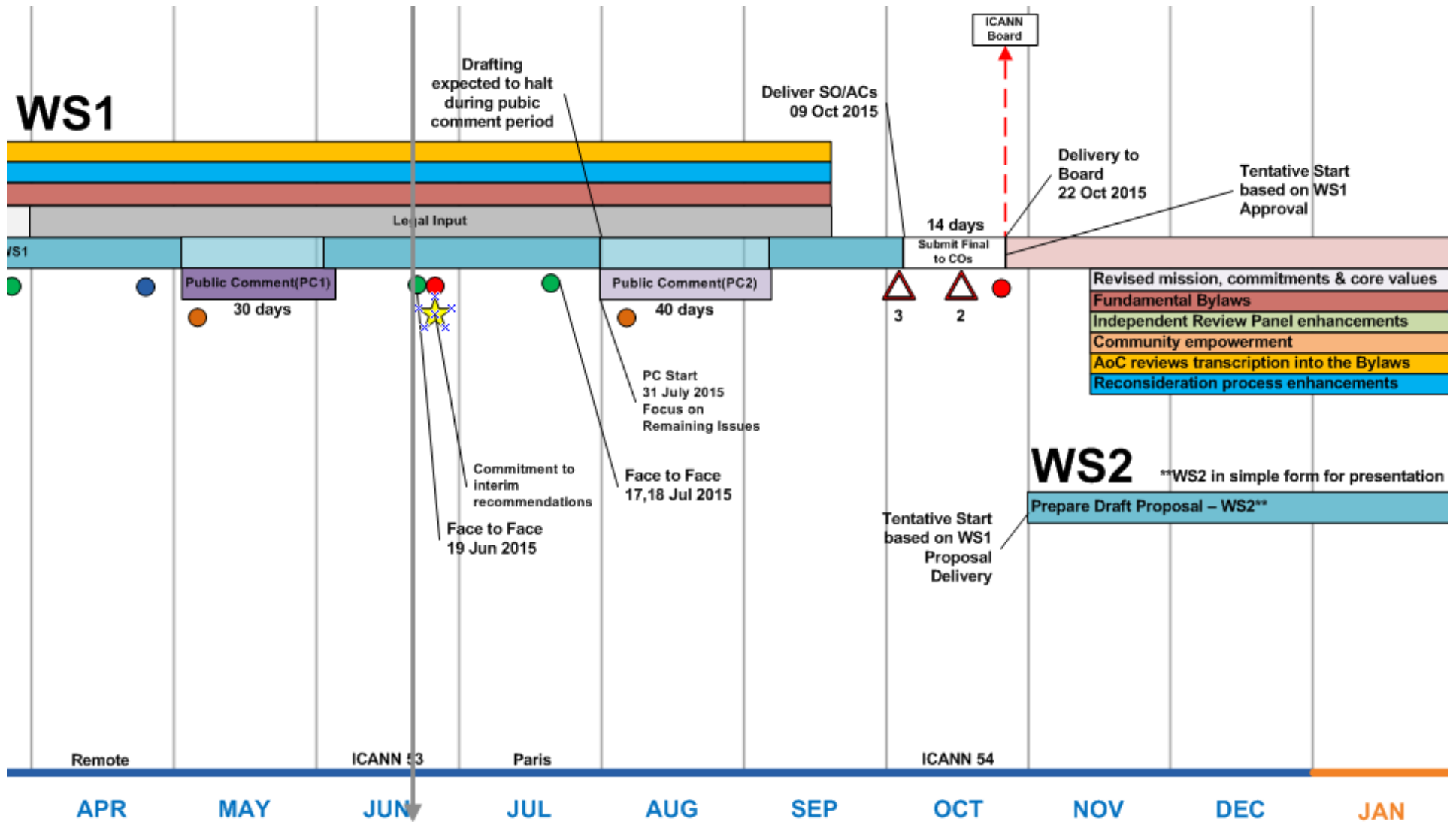



CCWG-Accountability
Public Comment Data

Comments by Type of Entity – 64 Total

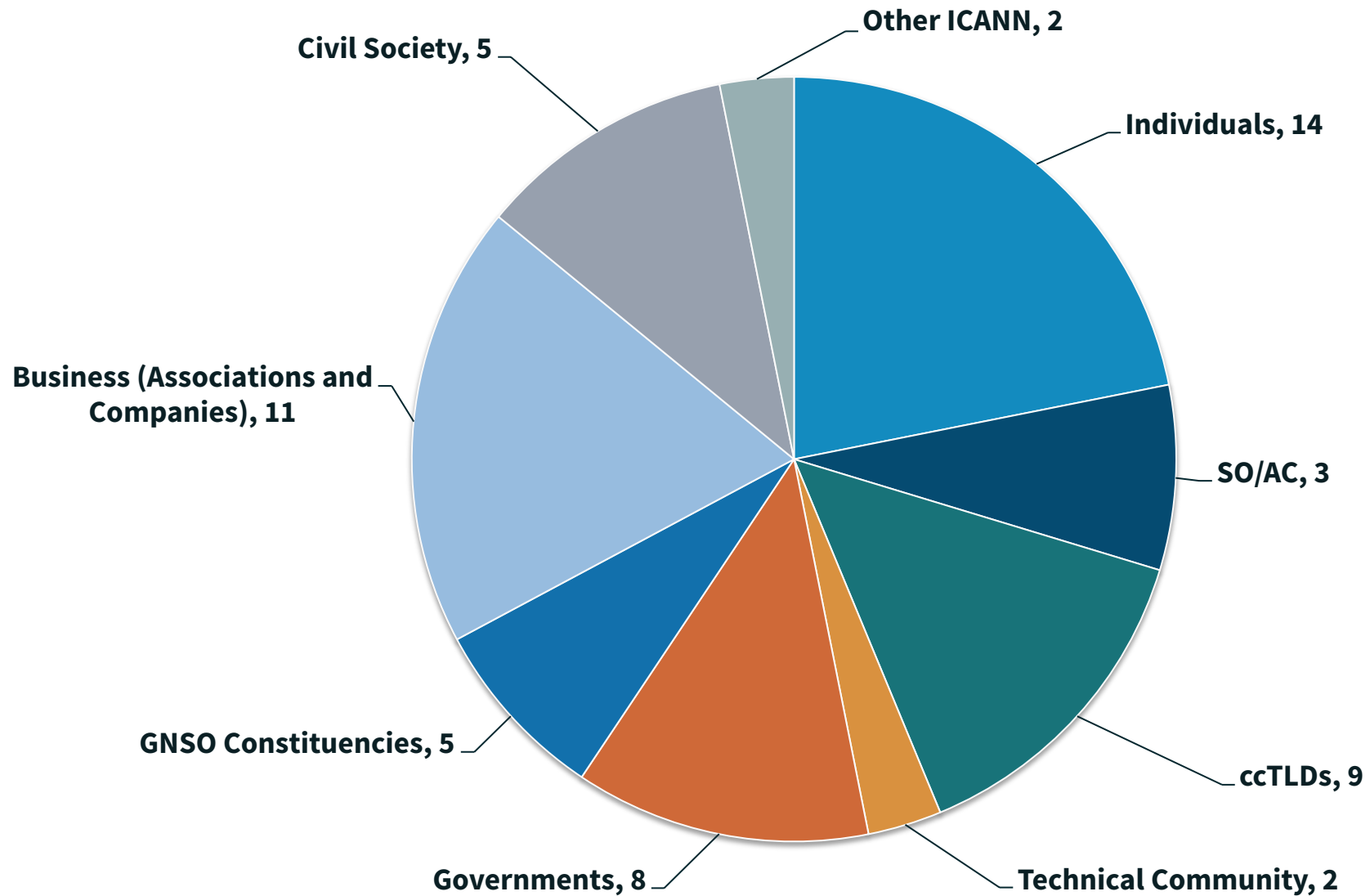

Comments by Question

Note: No data on question "Public Comment Input Framework"

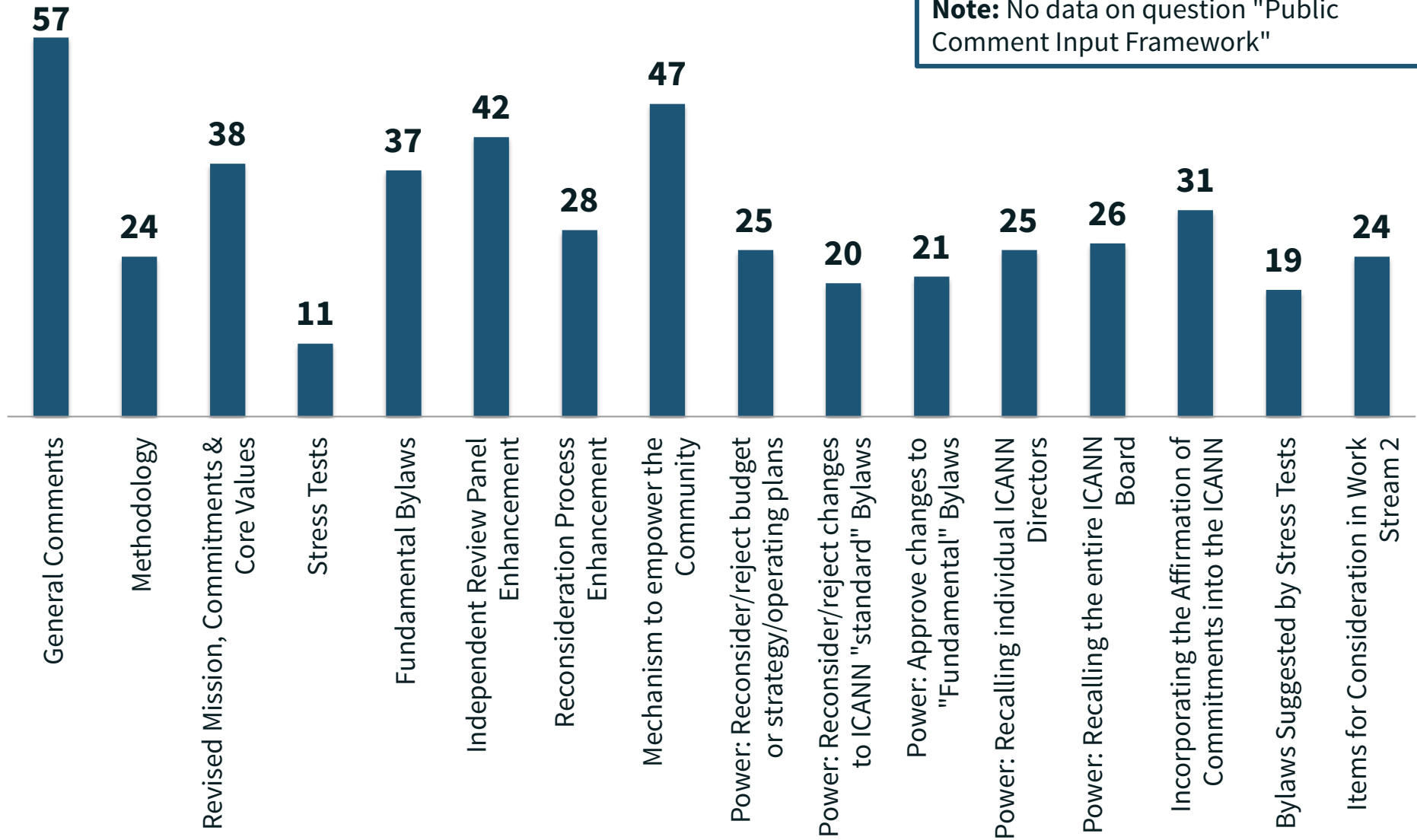

Comments by Region

