



ICANN | 53 
Buenos Aires

21-25 JUNE 2015

CWG-Stewardship Engagement Session

Domain Names Community
IANA Stewardship Transition



Statistics and Diversity

 **19**
Members

 **133**
Participants

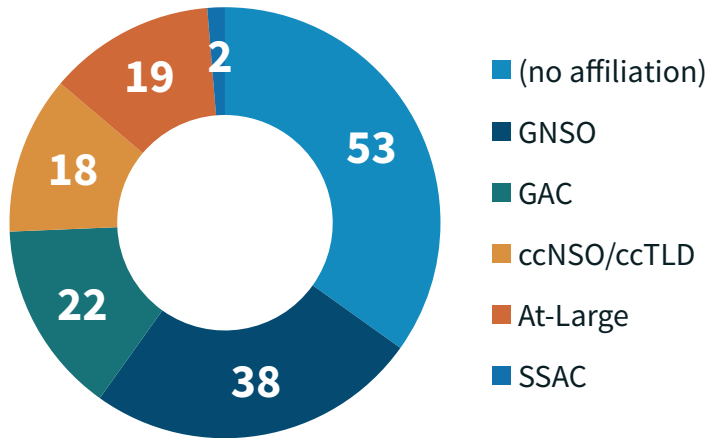

101
Calls/Meetings



4,893
Volunteer Hours



4000+
Mailing List
Messages



35
Average # per
Plenary Meeting

Part of a Process

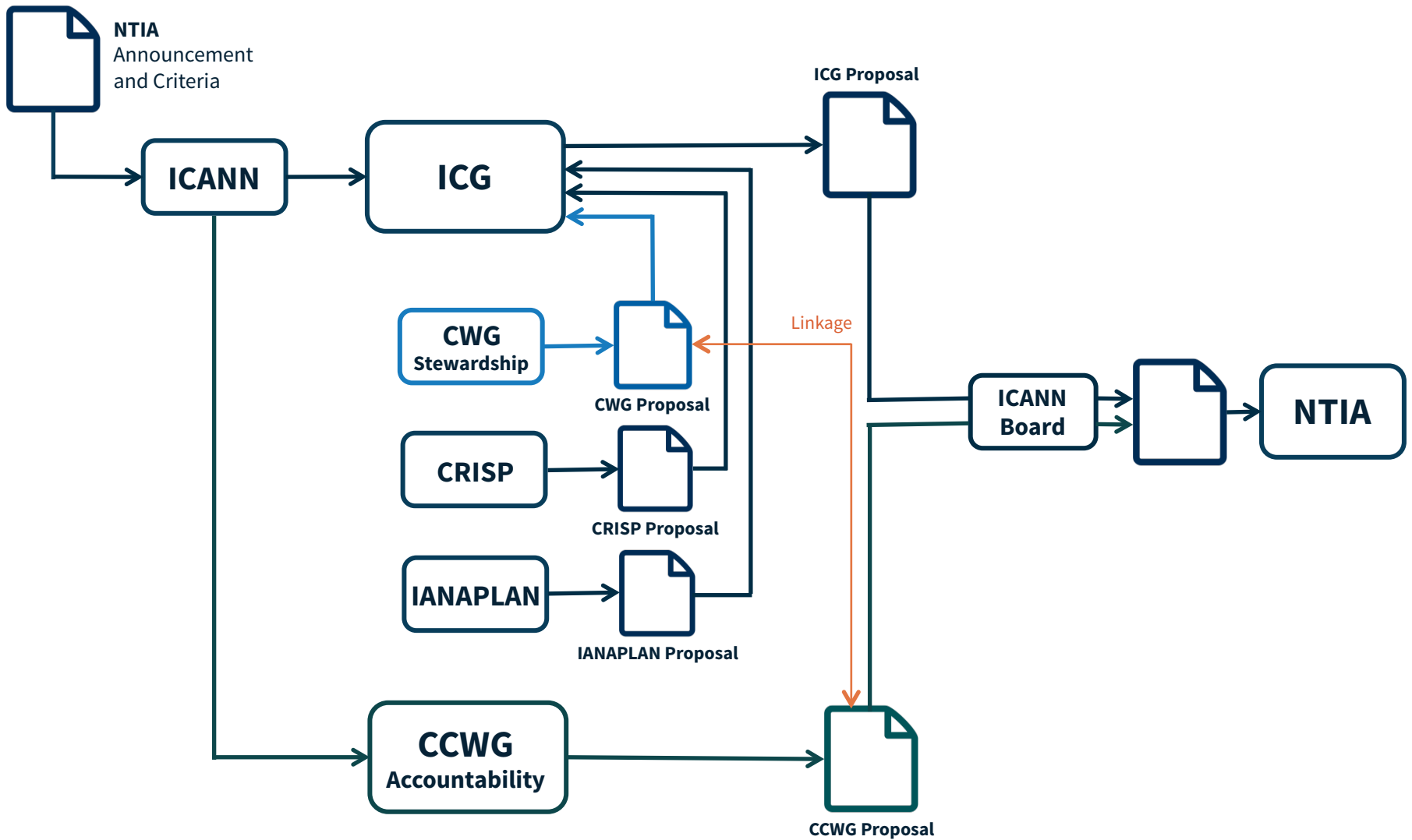

Goals and Requirements

Goal:

Produce a consolidated transition proposal for the elements of the IANA Functions relating to the Domain Name System.

A transition proposal for the Domain Names community would require:



A contract similar to the current IANA functions contract



A mechanism to approve changes to the Root Zone environment



Accountability mechanisms on ICANN with respect to the IANA functions



The ability to ensure adequate funding of the IANA Functions by ICANN



Additional insulation between operational and policymaking responsibilities and protections for the IANA Functions Operator



The ability for the multistakeholder community to require the selection of a new operator for the IANA Functions, if necessary

Finding Consensus on a Post-Transition Model

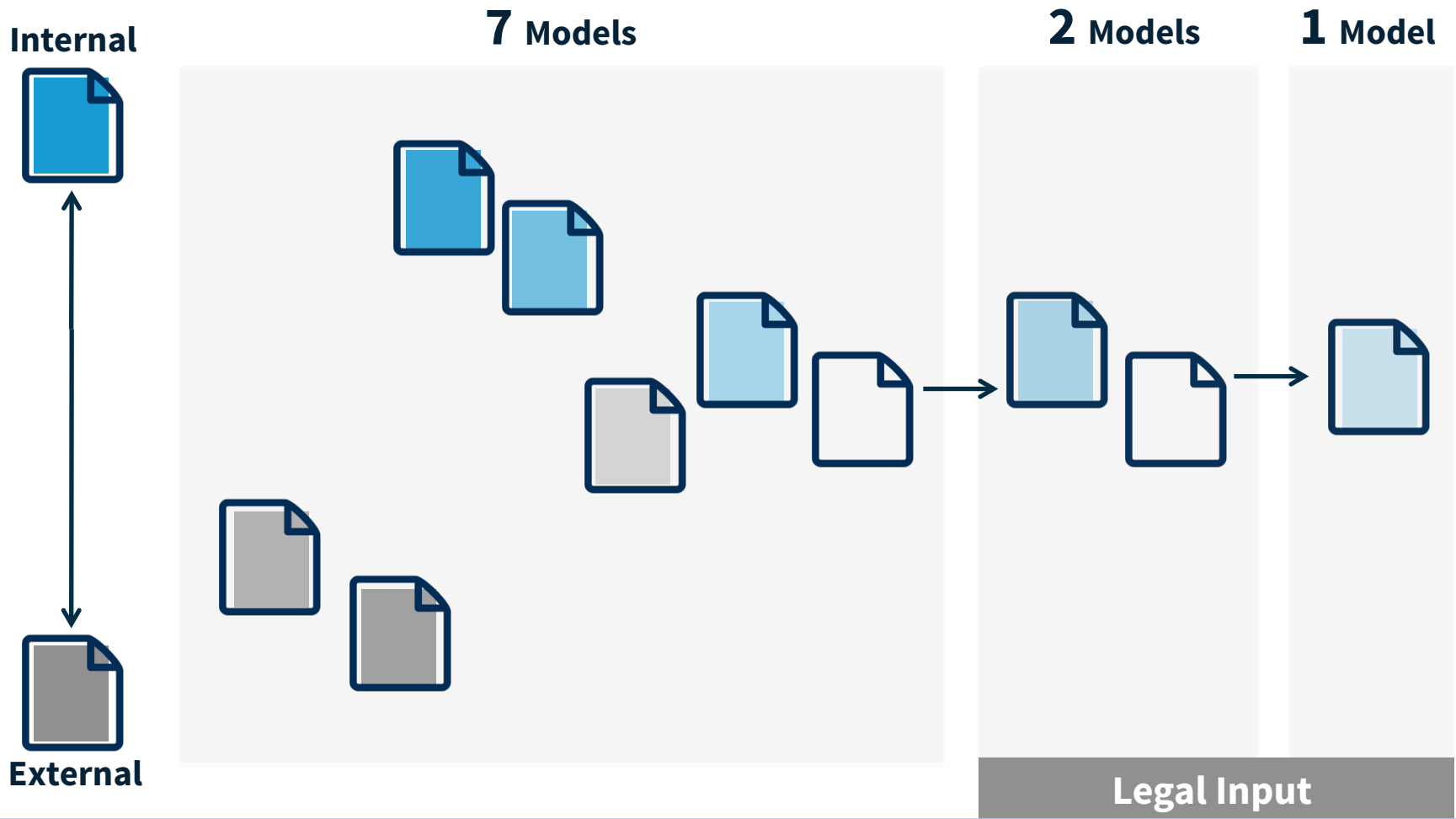

2014

2015

Structural Overview

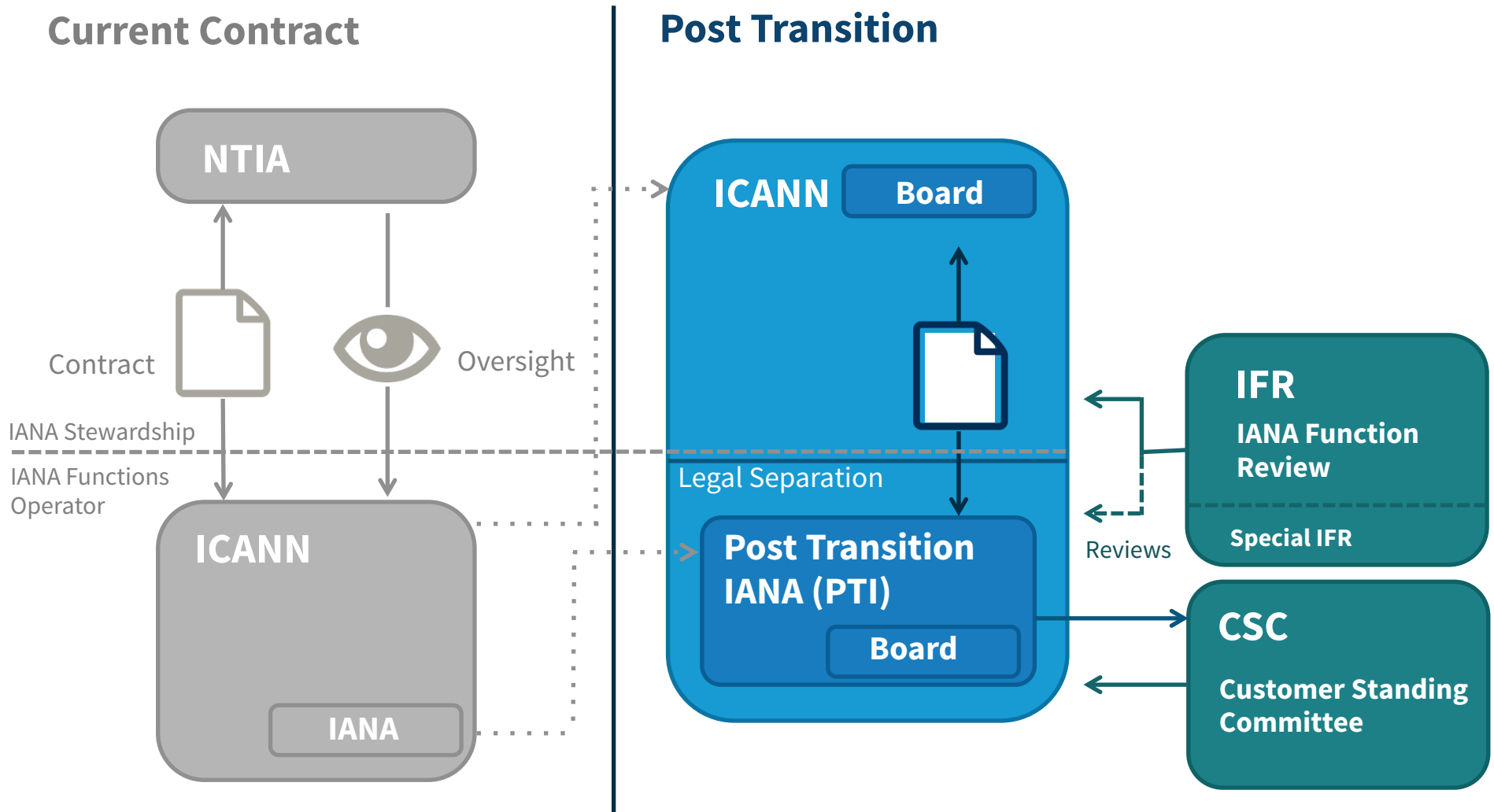

Post Transition IANA (PTI)

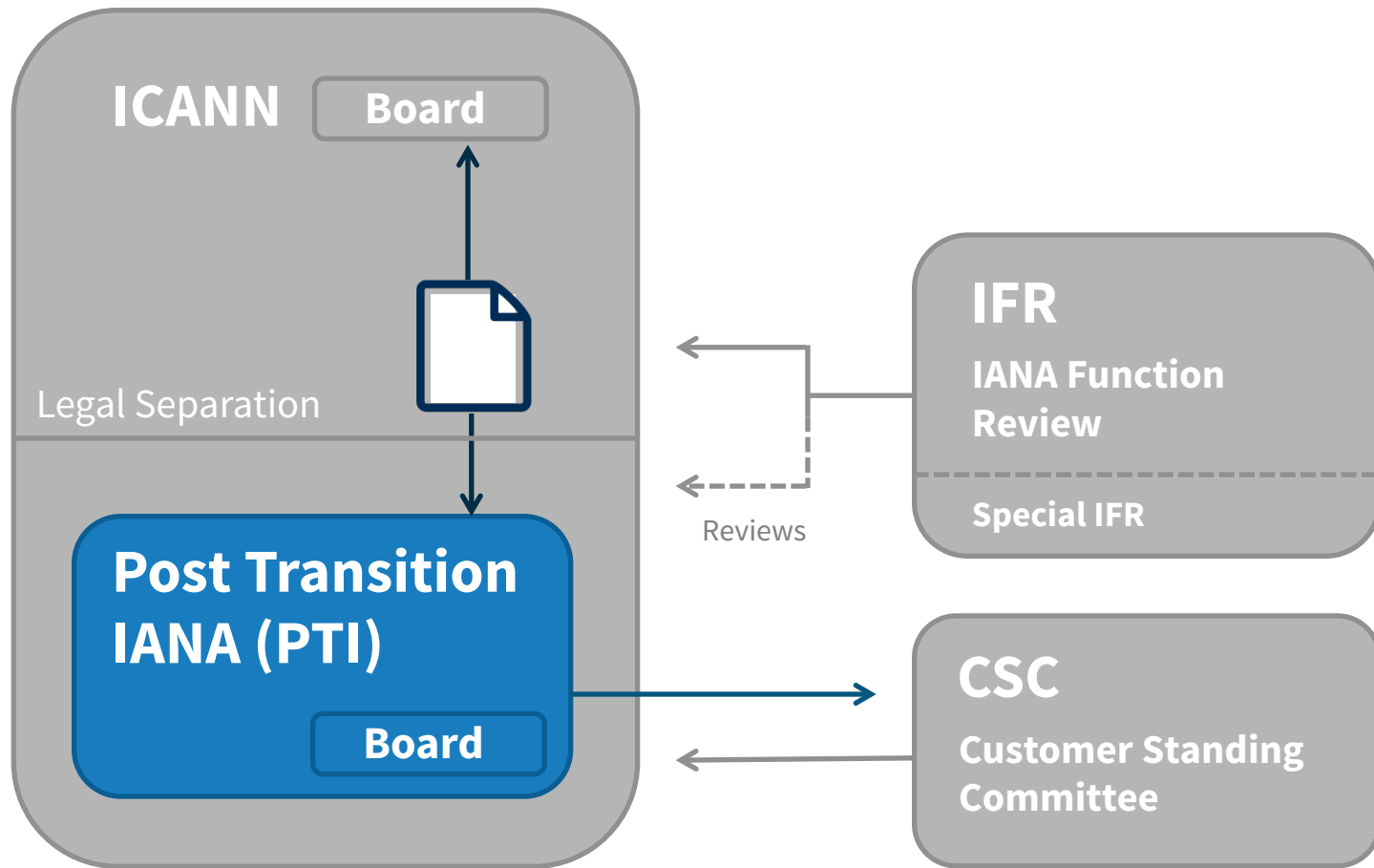

Customer Standing Committee (CSC)

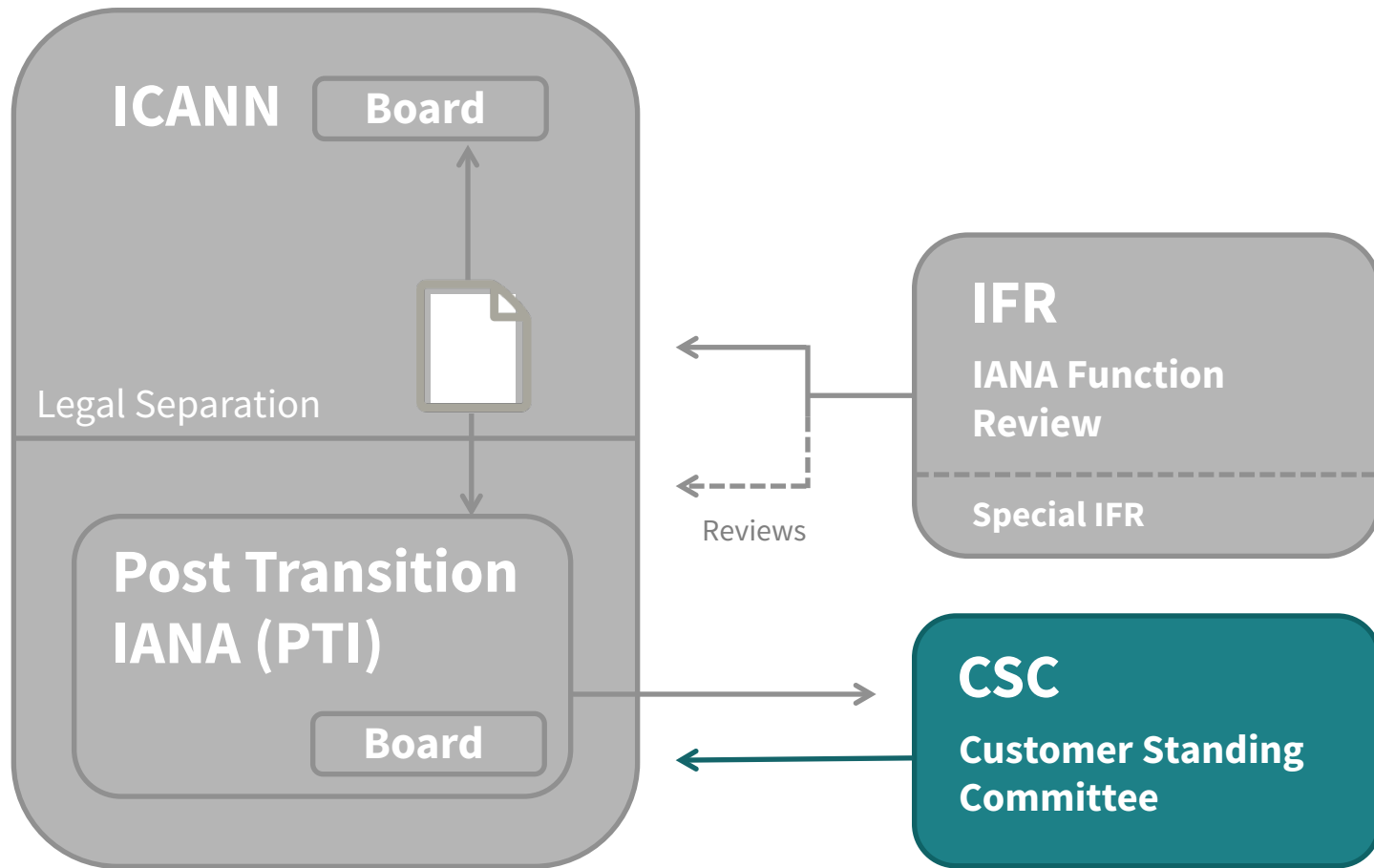

Post Transition IANA (IFR)

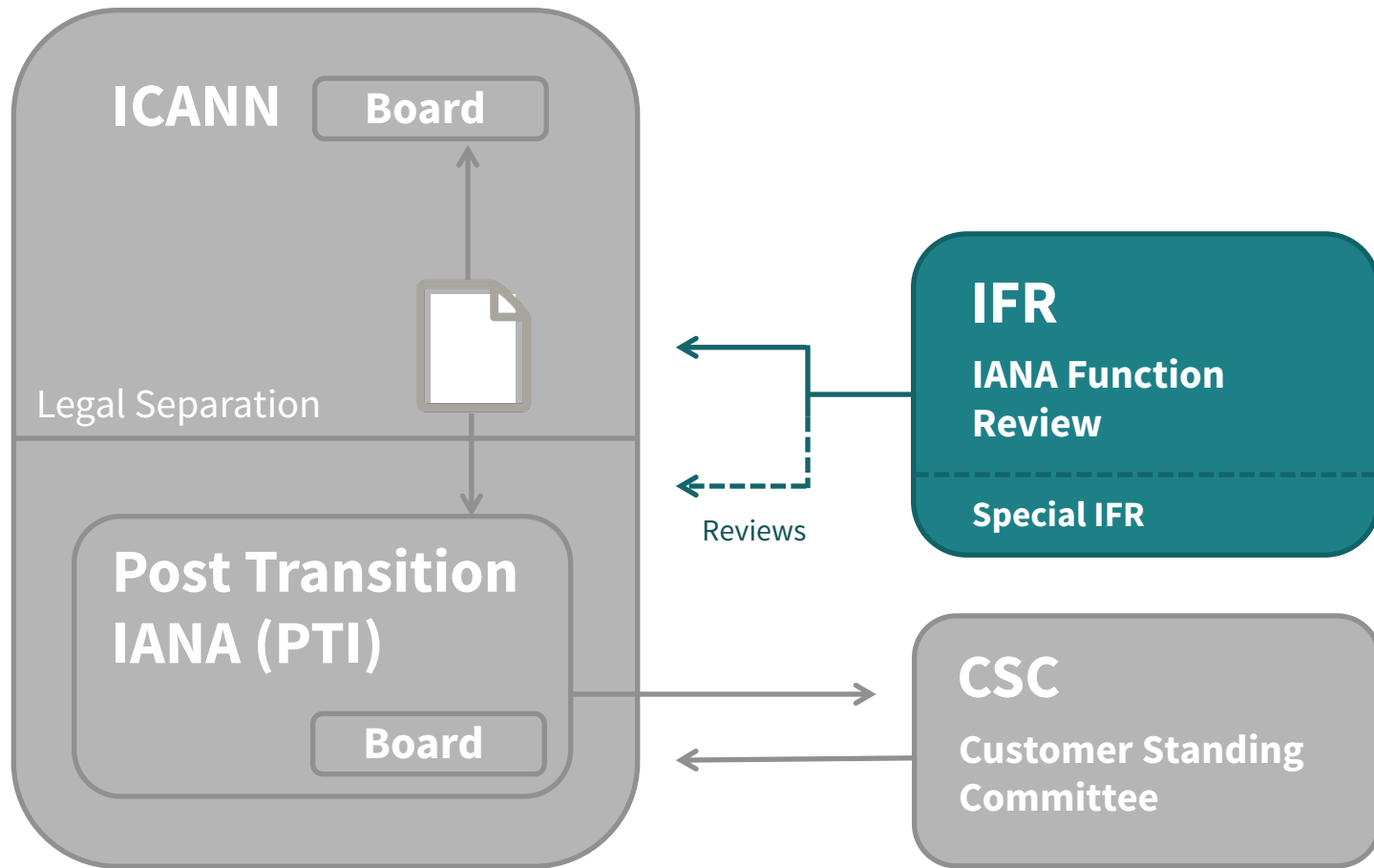

Linkage & Coordination with CCWG-Accountability

1

ICANN Budget

Community rights regarding development and consideration

4

Customer Standing Committee (CSC)

Incorporated into the bylaws

2

ICANN Board

Community rights, specifically to appoint/remove members, recall entire Board

5

Appeals Mechanism

Independent Review Panel should be made applicable to IANA Functions and accessible by TLD managers

3

IANA Function Review

Incorporated into the bylaws

6

Fundamental bylaws

All foregoing mechanisms are to be provided for in the bylaws as “fundamental bylaws”

The CWG-Stewardship’s proposal is expressly conditioned upon the outcomes of the CCWG-Accountability.

Completing our Process

The CWG-Stewardship sends Proposal to its Chartering Organizations for consideration and approval. **Goal is to transmit Proposal by end of ICANN 53.**

