

CWG-Stewardship

Cross Community Working Group to Develop an IANA Stewardship Transition Proposal on Naming Related Functions

Towards a Final Proposal

April 23, 2015 • v3.0

CWG-Stewardship: Part of a Process

April 23, 2015 • v3.0

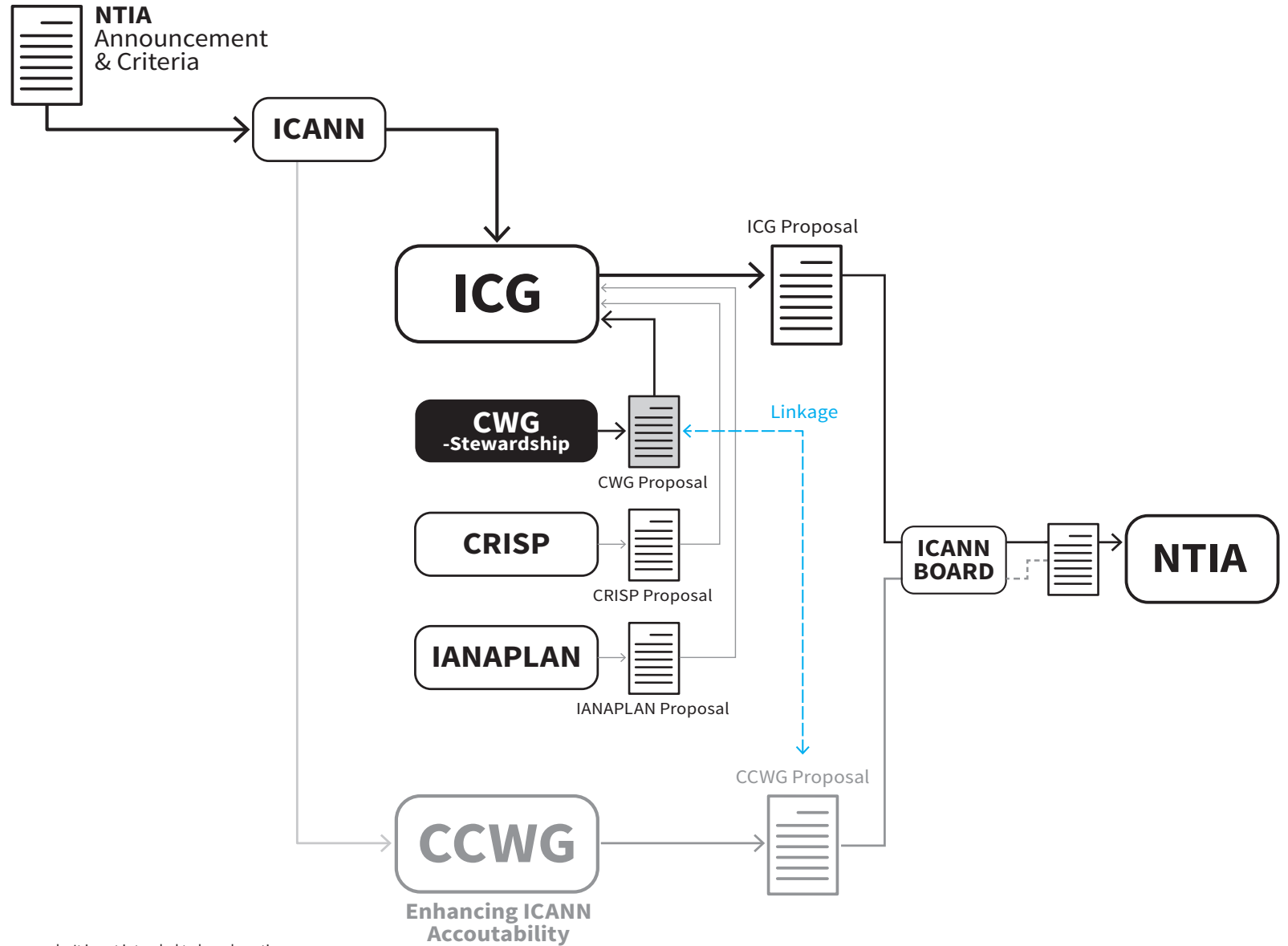

Note: the information on this page is for illustrative purposes only. It is not intended to be exhaustive.

CWG-Stewardship: **Goal & Scope**

April 23, 2015 • v3.0

The Goal of CWG-Stewardship

Produce a consolidated transition proposal for the elements of the IANA Functions relating to the Domain Name System.

The proposal must meet the needs of:

- The naming community in general
- All of the CWG-Stewardships' chartering organizations (ccNSO, SSAC, GNSO, ALAC, GAC)
- Direct consumers of IANA naming services including gTLDs and ccTLDs

The Scope of CWG-Stewardship

Based on a summary and description of the IANA Functions drawn from the NTIA's statement of work for that IANA Contract, IANA Functions Operator performs 11 functions.

The CWG-Stewardship is focused on 2-9 and 11

(but may also comment on 1 or 10).

1. Coordinates the assignment of technical protocol parameters including the management of the Address and Routing Parameter Area (ARPA) TLD;
2. Performs administrative functions associated with root zone management;
3. Manages root zone file change requests;
4. Manages "WHOIS" change requests and the WHOIS database;
5. Implements changes in the assignment of Country Code Top Level-Domains (ccTLDs) in accordance with established policy;
6. Implements decisions related to the delegation and redelegation of Generic Top Level Domain (gTLD) in accordance with ICANN policy;
7. Undertakes projects to increase root zone automation;
8. Manages Root Domain Name System Security Extensions (DNSSEC) keys;
9. Provides a Customer Service Complaint Resolution Process (CSCR);
10. Allocates Internet numbering resources; and
11. Performs other services (operate the .INTLD, implement modifications in performance of the IANA

CWG-Stewardship: Our Timeline • Progress to Date

April 23, 2015 • v3.0

Note: the information on this page is for illustrative purposes only. It is not intended to be exhaustive.



19 Members



125 Participants



94 Total Calls/ Meetings



4,688 Working Hours



3,922 Total Mailing List Exchanges

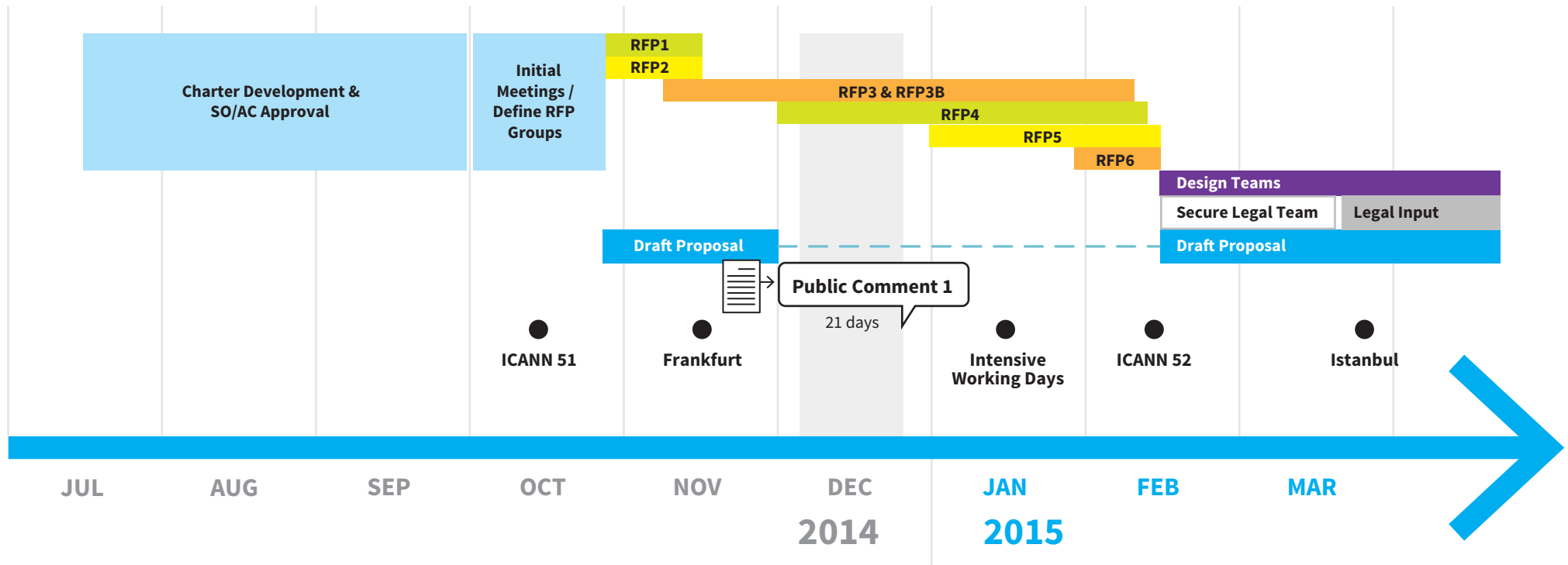

CWG-Stewardship: Proposal Development Overview

April 23, 2015 • v3.0

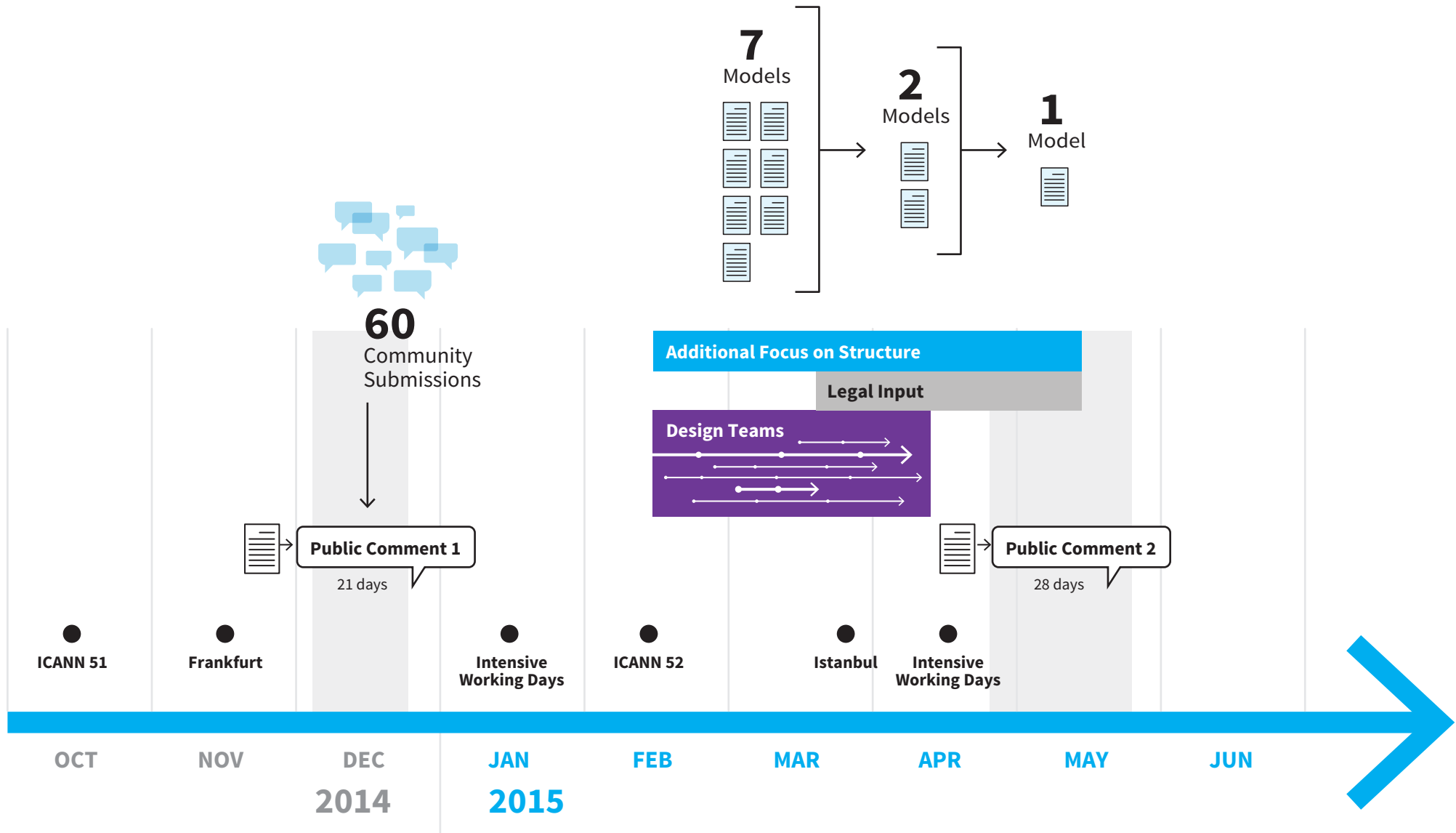

CWG-Stewardship: Linkage & Coordination with the CCWG-Accountability

April 23, 2015 • v3.0

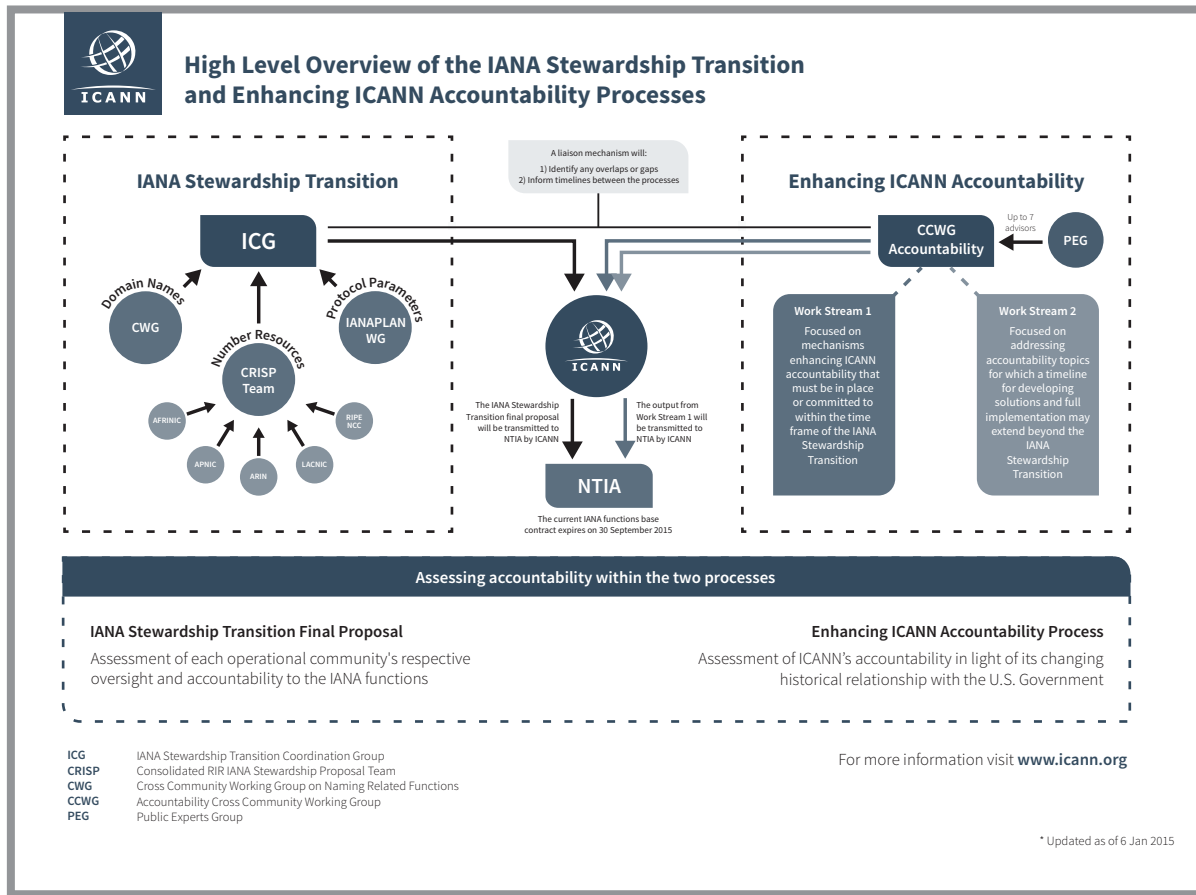

The Chairs recognize that continued and close engagement with the CCWG-Accountability is essential to the elaboration of a complete proposal, since aspects of the CWG-Stewardship proposal will be conditional on the output of the CCWG-Accountability.

What follows is a summary of the CWG-Stewardship's input, which was formally submitted to the CCWG-Accountability in a letter on 15 April, available here: <https://community.icann.org/x/DiknAw>.

continued on next page >>

Download full graphic here: <https://www.icann.org/en/system/files/files/iana-stewardship-accountability-07jan15-en.pdf>

CWG-Stewardship: Linkage & Coordination with the CCWG-Accountability

April 23, 2015 • v3.0

ICANN Budget

(in particular, relating to a confidence vote option)

The CWG-Stewardship supports the CCWG's proposal(s) for a budget veto tool, where the community has the option to reject an ICANN budget and send it back for further consideration and revision;

The CWG-Stewardship recommends as a part of its transition plan:

1. The IANA Function's comprehensive costs should be transparent for any future state of the IANA Function
2. Future FY ICANN Operating Plans & Budgets (including FY16 if possible) include at a minimum itemization of all IANA operations costs down to the project level and below as needed to the project level and below as needed

Community Empowerment Mechanisms

(in particular, relating to a confidence vote option)

The CWG-Stewardship will be relying on the community empowerment and accountability mechanisms that the CCWG-Accountability is currently considering and developing being in place at the time of the stewardship transition.

- The ability to review ICANN Board decisions relating to periodic or special reviews of the IANA Function
- The ability to approve or reject board decisions on the IANA Function Review as well as the related creation of a stakeholder community/ member group

Review and Redress Mechanisms

(in particular, relating to a 'fundamental bylaw' mechanism)

The CWG-Stewardship recommends regular reviews of the IANA Function take place.

- Reviews should happen every 5 years, and should operate in a manner analogous to an AoC review
- Reviews should be incorporated into ICANN's bylaw as part of a 'fundamental bylaw'
- A special review may be initiated following the CSC raising concerns with the GNSO and/or the ccNSO or by concerns raised by TLDs directly with the ccNSO or the GNSO

Appeal Mechanisms

(especially with regard to ccTLD related issues)

The CWG-Stewardship notes that ccTLDs may decide to develop their own appeals mechanism regarding re/delegation at a later date (post-transition), as such the CWG-Stewardship recommends:

- The CCWG-Accountability should not develop appeal mechanism(s) related to ccTLD delegation/ re-delegation issues
- The CCWG-Accountability should develop appeal mechanism(s) related to any other issues that may involve the IANA Function(s)

CWG-Stewardship: Design Teams Status • End of High Intensity Meetings

14 APR

7

April 23, 2015 • v3.0

	Priority	Status	Proposed Status	Links/Dependencies	Deadline
A IANA Service Level Expectations	1	In Progress	Prov. Complete	C, M, N / D	17 April
B Delegations / Redelegations Appeal	1	Submitted*	Complete		10 April
C Customer Standing Committee	1	Submitted*	Prov. Complete	J, H, N / A, D, M	10 April
D Authorization Function	1	Complete	Complete	F	–
E SAC 69	1	Complete	Complete	Red Team	–
F Relationships NTIA/IANA/Root Zone Maintainer	1	In Progress	Prov. Complete	D	17 April
G IANA Intellectual Property Rights	2	To Be Started	Not Needed/ Covered Elsewhere		–
H .INT Operations	2	To Be Started	Not Needed/ Covered Elsewhere		–
I Competition policy and Conflicts of Interest	2	To Be Started	Not Needed/ Covered Elsewhere		–
J CSC/MRT confidentiality and conflicts of interest	2	To Be Started	Not Needed/ Covered Elsewhere		–
K OFAC Licensing	2	To Be Started	Not Needed/ Covered Elsewhere		–
L Framework for Transition to Successor IANA Operator	1	Submitted*	Complete		10 April
M Escalation Mechanisms	1	Submitted*	Prov. Complete	A, C, N	10 April
N Periodic Review of the IANA Functions	1	Submitted*	Prov. Complete	A, C, M	10 April
O IANA Budget [NEW!]	–	Submitted*	Complete		10 April
● Red Team	–	To Be Started	Not Needed/ Covered Elsewhere		10 April

*Proposed content was submitted for review during high intensity meetings on 13-14 April

CWG-Stewardship: Internal Accountability Model

April 23, 2015 • v3.0

Current Contract

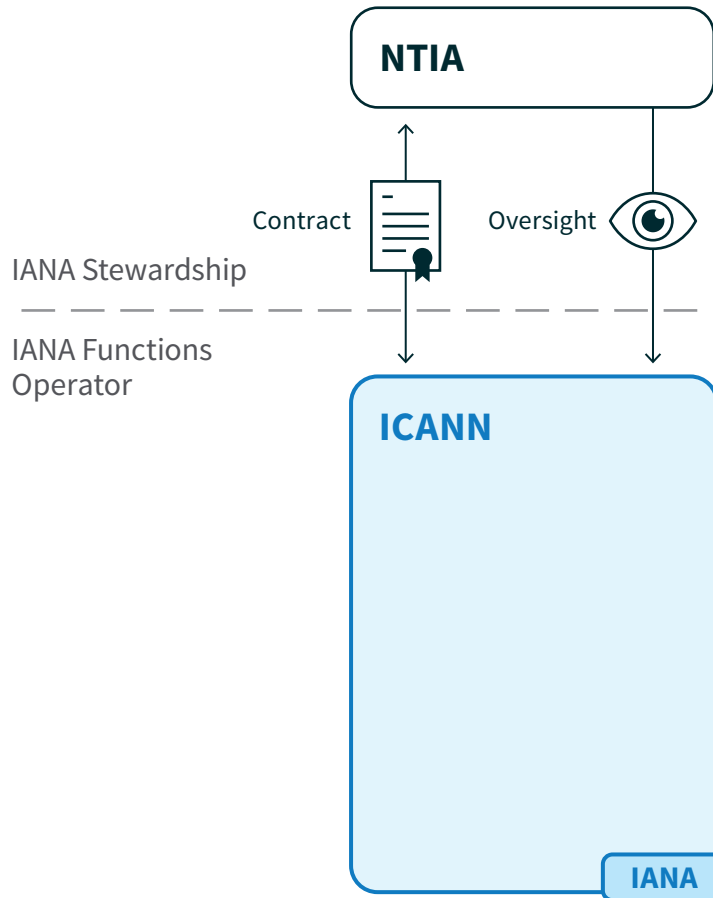

Post Transition

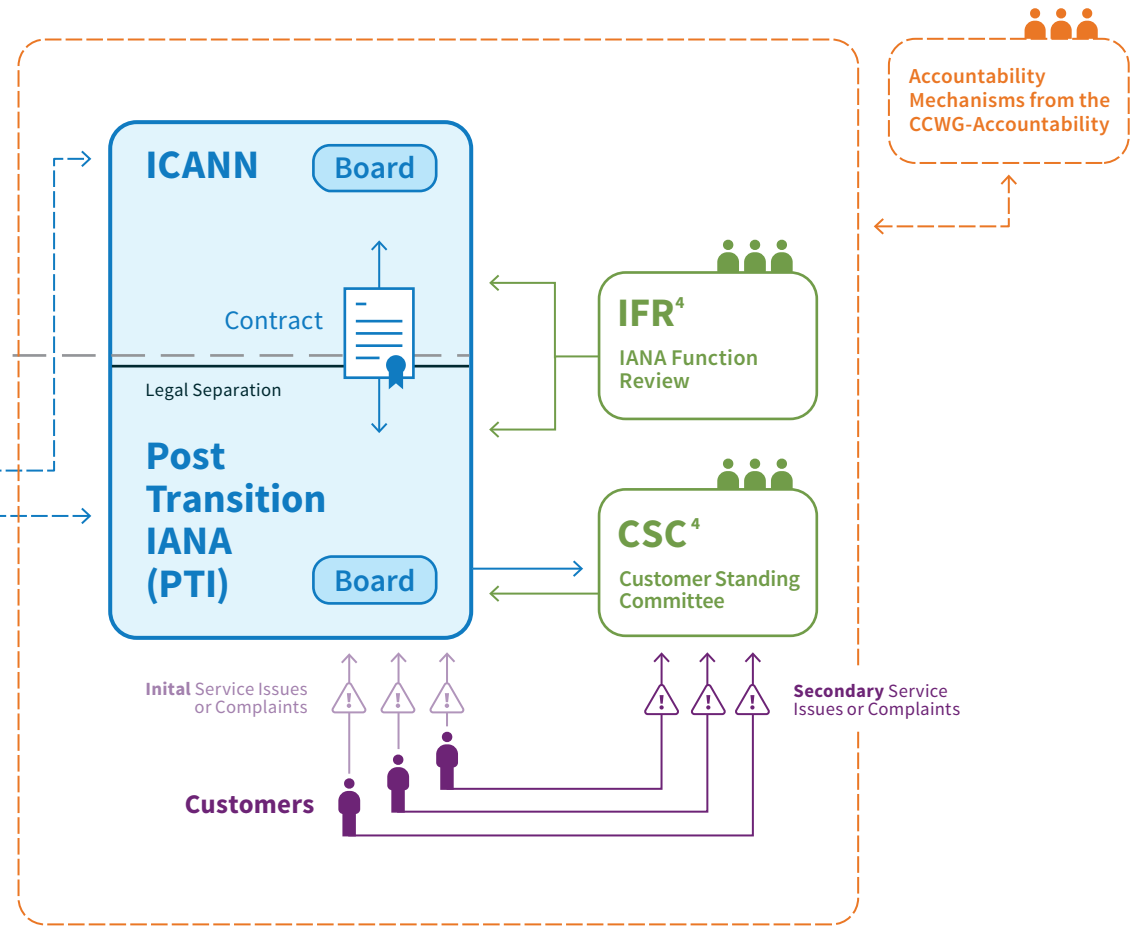

¹ The ultimate accountability mechanism is dependent on the work of the CCWG-Accountability.

⁴ Group, But Not Necessarily a Legal Entity

CWG-Stewardship: Our Timeline • The Road Ahead

April 23, 2015 • v3.0

Note: the information on this page is for illustrative purposes only. It is not intended to be exhaustive.

