

Final Report of the Temporary Specification for gTLD Registration Data Expedited Policy Development Process

Deleted: (Draft)

11 February 2019

Deleted: [Date]

Status of This Document

This is the Final Recommendations Report of the GNSO Expedited Policy Development Process (EPDP) Team on the Temporary Specification for gTLD Registration Data for submission to the GNSO Council.

Preamble

This Final Report documents the EPDP Team's: (i) deliberations and responses to the charter questions, (ii) input received on the EPDP's Initial Report and the EPDP Team's subsequent analysis (iii) policy recommendations and associated consensus levels, and (iv) implementation guidance, for GNSO Council consideration.

Table of Contents

<u>1 EXECUTIVE SUMMARY</u>	<u>3</u>
<u>2 OVERVIEW OF RECOMMENDATIONS</u>	<u>5</u>
<u>3 EPDP TEAM APPROACH</u>	<u>29</u>
<u>4 PUBLIC COMMENT ON THE EPDP TEAM INITIAL REPORT</u>	<u>32</u>
<u>5 EPDP TEAM RESPONSES TO CHARTER QUESTIONS & RECOMMENDATIONS</u>	<u>34</u>
<u>6 NEXT STEPS</u>	<u>78</u>
<u>GLOSSARY</u>	<u>79</u>
<u>ANNEX A - BACKGROUND</u>	<u>86</u>
<u>ANNEX B – EPDP TEAM MEMBERSHIP AND ATTENDANCE</u>	<u>87</u>
<u>ANNEX C - COMMUNITY INPUT</u>	<u>91</u>
<u>ANNEX D – DATA ELEMENTS WORKBOOKS</u>	<u>92</u>
<u>ANNEX E - CONSENSUS CALL PROCESS AND DESIGNATIONS TO DATE (11 FEBRUARY 2019)</u>	<u>148</u>

1 Executive Summary

On 17 May 2018, the ICANN Board of Directors (ICANN Board) adopted the [Temporary Specification for generic top-level domain \(gTLD\) Registration Data](#)¹ (“Temporary Specification”). The Temporary Specification modifies existing requirements in the Registrar Accreditation and Registry Agreements to comply with the European Union’s General Data Protection Regulation (“GDPR”)². In accordance with the ICANN Bylaws, the Temporary Specification will expire on 25 May 2019.

Formatted: No underline

On 19 July 2018, the GNSO Council [initiated](#) an Expedited Policy Development Process (EPDP) and [chartered](#) the EPDP on the Temporary Specification for gTLD Registration Data team. All GNSO Stakeholder Groups, Constituencies, and ICANN Advisory Committees, that indicated interest in participating, are represented on the EPDP Team, although the Charter limits the number of members per group.

The charter asks the EPDP to determine if the Temporary Specification for gTLD Registration Data should become an ICANN Consensus Policy as is, or with modifications. In addition, the result must comply with the GDPR and take into account other relevant privacy and data protection laws. Additionally, the EPDP Team’s charter requires discussion of a standardized access model to nonpublic registration data, after the EPDP Team completes policy recommendations and answers ‘gating questions.

On 21 November 2018, the EPDP Team published its [Initial Report for public comment](#). The Initial Report contained the EPDP Team’s preliminary recommendations and a set of questions for public comment. The EPDP Team also examined and made recommendations about: (i) the validity, legitimacy and legal basis of the purposes outlined in the Temporary Specification, (ii) the legitimacy, necessity and scope of (x) the registrar collection of registration data and (y) the transfer of data from registrars to registries, each as outlined in the Temporary Specification, and (iv) the publication of registration data by registrars and registries as outlined in the Temporary Specification.

The Initial Report also provided preliminary recommendations and questions for the public to consider: (i) the transfer of data from registrars and registries to escrow providers and ICANN, (ii) the transfer of data from registries to emergency back-end registry operators (“EBERO”), (iii) the definition and framework for reasonable access to registration data, (iv) respective roles and responsibilities under the GDPR, i.e., the responsible parties, (v) applicable updates to ICANN Consensus Policies, and (vi) future

¹ Because the Temporary Specification is central to the EPDP Team’s work, readers unfamiliar with the Temporary Specification may wish to read it before reading this Initial Report to gain a better understanding of and context for this Final Report.

² The GDPR can be found at <https://eur-lex.europa.eu/eli/reg/2016/679/oj>; for information on the GDPR see, <https://ico.org.uk/for-organisations/guide-to-the-general-data-protection-regulation-gdpr/lawful-basis-for-processing/contract/>

work by the GNSO to ensure relevant Consensus Policies are reassessed to become consistent with applicable law.

The EPDP Team documented each of the data processing steps, and the purpose and the legal basis for each. This foundational work was necessary to develop GDPR-compliant solutions and is available in the Report's Appendix.

After the publication of the Initial Report, the EPDP Team: (i) sought guidance on legal issues, (ii) carefully reviewed public comments received in response to the publication of the Initial Report, (iii) reviewed the work-in-progress with the community groups the Team members represent, (iv) deliberated for the production of this Final Report that will be reviewed by the GNSO Council and, if approved, forwarded to the ICANN Board of Directors for approval as an ICANN Consensus Policy. Consensus calls on the recommendations contained in this Final Report, as required by the GNSO Working Group Guidelines, were carried out by the EPDP Team Chair, as described here: <https://mm.icann.org/pipermail/gnso-epdp-team/2019-February/001436.html>.

2 Overview of Recommendations

The GNSO Council chartered this EPDP Team to determine if the Temporary Specification for gTLD Registration Data should become an ICANN Consensus Policy as is, or with Proposed Responses to the Charter Questions & Preliminary Recommendations.

After reviewing the public comments on the Initial Report and updating the recommendations, the EPDP Team presents its recommendations for GNSO Council consideration. [\[Note that the consensus call process has not been completed yet. As such, designations may change. See Annex E for further details.\]](#)

Deleted: This Final Report states the level of consensus within the EPDP Team for each recommendation.

2.1 Recommendations for Council consideration

EPDP Team Recommendation #1.

The EPDP Team recommends that the following ICANN Purposes for processing gTLD Registration Data form the basis of the new ICANN policy:

1. a. In accordance with the relevant registry agreements and registrar accreditation agreements, activate a registered name and allocate it to the Registered Name Holder.
 - b. Subject to the Registry and Registrar Terms, Conditions and Policies and ICANN Consensus Policies:
 - (i) Establish the rights of a Registered Name Holder in a Registered Name; and
 - (ii) Ensure that a Registered Name Holder may exercise its right in the use, maintenance and disposition of the Registered Name.;
2. Contributing to the maintenance of the security, stability, and resiliency of the Domain Name System in accordance with ICANN's mission through enabling responses to lawful data disclosure requests.³
3. Enable communication with the Registered Name Holder on matters relating to the Registered Name;
4. Provide mechanisms for safeguarding Registered Name Holders' Registration Data in the event of a business or technical failure of a Registrar or Registry Operator, or unavailability of a Registrar or Registry Operator, as described in the RAA and RA, respectively;
5. i) Handle contractual compliance monitoring requests and audit activities consistent with the terms of the Registry agreement and the Registrar accreditation agreements and any applicable data processing agreements, by processing specific data only as necessary;

³ Purpose 2 should not preclude disclosure in the course of investigating intellectual property infringement.

- ii) Handle compliance complaints initiated by ICANN, or third parties consistent with the terms of the Registry agreement and the Registrar accreditation agreements.
6. Operationalize policies for the resolution of disputes regarding or relating to the registration of domain names (as opposed to the use of such domain names, but including where such policies take into account use of the domain names), namely, the UDRP, URS, PDDRP, RRDRP, and the TDRP; and
 7. Enabling validation to confirm that Registered Name Holder meets gTLD registration policy eligibility criteria voluntarily adopted by Registry Operator and that are described or referenced in the Registry Agreement for that gTLD.⁴

EPDP Team Recommendation #2.

[[[The EPDP Team commits to considering in Phase 2 of its work whether additional purposes should be considered to facilitate ICANN's Office of the Chief Technology Officer (OCTO) to carry out its mission (see <https://www.icann.org/octo>). This consideration should be informed by legal guidance on if/how provisions in the GDPR concerning research apply to ICANN Org and the expression for the need of such pseudonymized data by ICANN.]]]

Deleted:

EPDP Team Recommendation #3.

In accordance with the EPDP Team Charter and in line with Purpose #2, the EPDP Team undertakes to make a recommendation pertaining to a standardised model for lawful disclosure of non-public Registration Data (referred to in the Charter as 'Standardised Access') now that the gating questions in the charter have been answered. This will include addressing questions such as:

- Whether such a system should be adopted
- What are the legitimate purposes for third parties to access registration data?
- What are the eligibility criteria for access to non-public Registration data?
- Do those parties/groups consist of different types of third-party requestors?
- What data elements should each user/party have access to?

In this context, the EPDP team will consider amongst other issues, disclosure in the course of intellectual property infringement and DNS abuse cases.⁵

⁴ The EPDP Team's approval of Purpose 7 does not prevent and should not be interpreted as preventing Registry Operators from voluntarily adopting gTLD registration policy eligibility criteria that are not described or referenced in their respective Registry Agreements.

⁵ The EPDP recognizes that ICANN has a responsibility to foster the openness, interoperability, resilience, security and/or stability of the DNS in accordance with its stated mission (citation required). It may have a purpose to require actors in the ecosystem to respond to data disclosure requests that are related to the security, stability and resilience of the system. The proposed Purpose 2 in this report is a placeholder, pending further legal analysis of the controller/joint controller relationship, and consultation with the EDPB. The EPDP recommends that further work be

Deleted: 9 February 2019

There is a need to confirm that disclosure for legitimate purposes is not incompatible with the purposes for which such data has been collected.

EPDP Team Recommendation #4.

The EPDP Team recommends that requirements related to the accuracy of registration data under the current ICANN contracts and consensus policies shall not be affected by this policy.⁶

Deleted: [This section is to be updated following finalization of the recommendations]

EPDP Team Recommendation #5.

The EPDP Team recommends that the data elements listed below (as illustrated in the data elements workbooks in Annex D) are required to be collected by registrars. In the aggregate, this means that the following data elements are to be collected⁷ where some data elements are automatically generated and, as indicated below, in some cases it is optional for the registered name holder to provide those data elements:

Data Elements (Collected & Generated ⁸)	
Domain Name	
Registrar Whois Server*	
Registrar URL*	
Updated Date*	
Registrar Registration Expiration Date*	
Registrar*	
Registrar IANA ID*	
Registrar Abuse Contact Email*	
Registrar Abuse Contact Phone*	
Reseller*	
Domain Status(es)*	
Registrant Fields	
	<ul style="list-style-type: none"> • Name • Organization (opt.) • Street • City • State/province

done in phase 2 on these issues, including a review of a limited purpose related to the enforcement of contracted party accountability for disclosure of personal data to legitimate requests.

⁶ The topic of accuracy as related to GDPR compliance is expected to be considered further as well as the WHOIS Accuracy Reporting System.

⁷ For those data elements marked as “(optional)”, these are optional for the RNH to provide.

⁸ Data Elements indicated with * are generated either by the Registrar or the Registry

Deleted: 9 February 2019

• Postal code
• Country
• Phone
• Phone ext (opt.)
• Fax (opt.)
• Fax ext (opt.)
• Email
Tech Fields
• Name
• Phone
• Email
Name Server
DNSSEC
Name Server IP Address
Last Update of Whois Database*
• Additional data elements as identified by Registry Operator in its registration policy, such as (i) status as Registry Operator Affiliate or Trademark Licensee [.MICROSOFT]; (ii) membership in community [.ECO]; (iii) licensing, registration or appropriate permits (.PHARMACY, .LAW) place of domicile [.NYC]; (iv) business entity or activity [.BANK, .BOT]

For further details, see [complete data elements matrix](#).

Field Code Changed

For the purpose of the Technical contact, which is optional for the Registered Name Holder to complete (and if the Registrar provides this option), Registrars are to advise the Registered Name Holder at the time of registration that the Registered Name Holder is free to (1) designate the same person as the registrant (or its representative) as the technical contact; or (2) provide contact information which does not directly identify the technical contact person concerned.

EPDP Team Recommendation #6.
 The EPDP Team recommends that, as soon as commercially reasonable, Registrar must provide the opportunity for the Registered Name Holder to provide its Consent to publish additional contact information in the RDS for the sponsoring registrar.

EPDP Team Recommendation #7.
 The EPDP Team recommends that the specifically-identified data elements under “[t]ransmission of registration data from Registrar to Registry”, as illustrated in the aggregate data elements workbooks, must be transferred from registrar to registry

Deleted: 9 February 2019

provided an appropriate legal basis exists and data processing agreement is in place. In the aggregate, these data elements are:

Data Elements (Collected & Generated ⁹)
Domain Name
Registrar Whois Server*
Registrar URL*
Updated Date*
Registrar Registration Expiration Date*
Registrar*
Registrar IANA ID*
Registrar Abuse Contact Email*
Registrar Abuse Contact Phone*
Reseller*
Domain Status(es)*
Registrant Fields
• Name
• Organization (opt.)
• Street
• City
• State/province
• Postal code
• Country
• Phone
• Phone ext (opt.)
• Fax (opt.)
• Fax ext (opt.)
• Email
<u>Tech</u> Fields
• Name
• Phone
• Email
Name Server
DNSSEC
Name Server IP Address
Last Update of Whois Database*

Deleted: Admin

⁹ Data Elements indicated with * are generated either by the Registrar or the Registry

Deleted: 9 February 2019

- Additional data elements as identified by Registry Operator in its registration policy, such as (i) status as Registry Operator Affiliate or Trademark Licensee [.MICROSOFT]; (ii) membership in community [.ECO]; (iii) licensing, registration or appropriate permits (.PHARMACY, .LAW) place of domicile [.NYC]; (iv) business entity or activity [.BANK, .BOT]

For illustrative purposes, see [complete data elements matrix](#).

Field Code Changed

EPDP Team Recommendation #8.

1. The EPDP Team recommends that ICANN Org develops legally-compliant data protection agreements with the data escrow providers.
2. The EPDP Team recommends updates to the contractual requirements for registries and registrars to transfer data that they process to the data escrow provider to ensure consistency with the data elements listed below (for illustrative purposes, see relevant workbooks in Annex D that analyze the purpose to provide mechanisms for safeguarding Registered Name Holders' Registration Data).
3. The data elements to be transferred by Registries and Registrars to data escrow providers are:

For registrars:

Data Elements (Collected & Generated ¹⁰)
Domain Name
Registrar Registration Expiration Date*
Registrar*
Reseller*
Registrant Fields
<ul style="list-style-type: none"> • Name
<ul style="list-style-type: none"> • Street
<ul style="list-style-type: none"> • City
<ul style="list-style-type: none"> • State/province
<ul style="list-style-type: none"> • Postal code
<ul style="list-style-type: none"> • Country
<ul style="list-style-type: none"> • Phone
<ul style="list-style-type: none"> • Email

¹⁰ Data Elements indicated with * are generated either by the Registrar or the Registry

For registries:

Data Elements (Collected & Generated ¹¹)
Domain Name
Registry Domain ID*
Registrar Whois Server*
Registrar URL*
Updated Date*
Creation Date*
Registry Expiry Date*
Registrar Registration Expiration Date*
Registrar*
Registrar IANA ID*
Registrar Abuse Contact Email*
Registrar Abuse Contact Phone*
Reseller*
Domain Status(es)*
Registry Registrant ID*
Registrant Fields
• Name
• Organization (opt.)
• Street
• City
• State/province
• Postal code
• Country
• Phone
• Phone ext (opt.)
• Fax (opt.)
• Fax ext (opt.)
• Email
Tech ID*
Tech Fields
• Name
• Phone
• Email

¹¹ Data Elements indicated with * are generated either by the Registrar or the Registry

Deleted: 9 February 2019

Name Server
DNSSEC
Name Server IP Address
<ul style="list-style-type: none"> Additional data elements as identified by Registry Operator in its registration policy, such as (i) status as Registry Operator Affiliate or Trademark Licensee [.MICROSOFT]; (ii) membership in community [.ECO]; (iii) licensing, registration or appropriate permits (.PHARMACY, .LAW] place of domicile [.NYC]; (iv) business entity or activity [.BANK, .BOT]

Deleted: Last Update of Whois Database* ... [1]

EPDP Team Recommendation #9.

1. The EPDP Team recommends that updates are made to the contractual requirements concerning the registration data elements for registries and registrars to transfer to ICANN Org the domain name registration data that they process when required/requested for purpose 5 (Contractual Compliance), consistent with the data elements listed hereunder (for illustrative purposes, please see the workbook that analyzes the purpose to handle contractual compliance monitoring requests, audits, and complaints submitted by Registry Operators, Registrars, Registered Name Holders, and other Internet users in Annex D).
2. The EPDP Team recommends that the following data elements be transferred from registries and registrars to ICANN Org for purpose 5 (Contractual Compliance)¹²:

Data Elements (Collected & Generated ¹³)
Domain Name
Registry Domain ID*
Registrar Whois Server*
Registrar URL*
Updated Date*
Creation Date*
Registry Expiry Date*
Registrar Registration Expiration Date*
Registrar*

¹² To clarify, the data elements listed here are the aggregate of data elements that ICANN Compliance may request. As noted in the [Summary of ICANN Organization's Contractual Compliance Team Data Processing Activities](#) "If the Contractual Compliance Team is unable to validate the issue(s) outlined in a complaint because the publicly available WHOIS data is redacted/masked, it will request the redacted/masked registration data directly from the contracted party (or its representative). In these instances, the Contractual Compliance Team will only request the redacted/masked data elements that are needed to validate the issue(s) outlined in the complaint".

¹³ Data Elements indicated with * are generated either by the Registrar or the Registry

Registrar IANA ID*
Registrar Abuse Contact Email*
Registrar Abuse Contact Phone*
Reseller*
Domain Status(es)*
Registry Registrant ID*
Registrant Fields
• Name
• Organization (opt.)
• Street
• City
• State/province
• Postal code
• Country
• Phone
• Phone ext (opt.)
• Fax (opt.)
• Fax ext (opt.)
• Email
Tech ID*
Tech Fields
• Name
• Phone
• Email
Name Server
DNSSEC
Name Server IP Address
Last Update of Whois Database*

EPDP Team Recommendation #10.

Requirements for processing personal data in public RDDS where processing is subject to GDPR: The EPDP Team recommends that redaction must be applied as follows to the data elements that are collected. Data elements neither redacted nor anonymized must appear via free public based query access¹⁴:

¹⁴ As noted in the data elements workbooks, "a minimum public data set of registration data will be made available for query of gTLD second level domains in a freely accessible directory. Where a data element has been designated as non-public, it will be redacted".

Data Elements	Redacted
Domain Name	No
Registrar Whois Server	No
Registrar URL	No
Updated Date	No
Creation Date	No
Registry Expiry Date	No
Registrar Registration Expiration Date	No
Registrar	No
Registrar IANA ID	No
Registrar Abuse Contact Email	No
Registrar Abuse Contact Phone	No
Reseller	No
Domain Status	No
Registry Registrant ID	Yes
Registrant Fields	
• Name	Yes
• Organization (opt.)	Yes/No ¹⁵
• Street	Yes
• State/province	No
• Postal code	Yes
• Country	No
• Phone	Yes
• Email	Yes ¹⁶
• Anonymized email / link to web form	No
Tech ID	Yes
Tech Fields	
• Name	Yes
• Phone	Yes
• Email	Yes ¹⁷
• Anonymized email / link to web form	No

¹⁵ See recommendation #13 for further details in relation to the publication of the Organization field.

¹⁶ The EPDP Team recommends that the 17 May 2018 Temp Spec requirement that a Registrar MUST provide an email address or a web form to facilitate email communication with the relevant contact, but MUST NOT identify the contact email address or the contact itself, continue to be in effect. See also the related recommendation #14 .

¹⁷ The EPDP Team recommends that the 17 May 2018 Temp Spec requirement that a Registrar MUST provide an email address or a web form to facilitate email communication with the relevant contact, but MUST NOT identify the contact email address or the contact itself, continue to be in effect. See also the related recommendation #14.

Data Elements	Redacted
NameServer(s)	No
DNSSEC	No
Name Server IP Address	No
Last Update of Whois Database	No

The EPDP Team also confirms that Registry Operator and Registrar MAY apply the requirements outlined in this recommendation, as well as recommendation #12, #13, #14 and #15 (i) where it has a commercially reasonable purpose to do so, or (ii) where it is not technically feasible to limit application of these requirements.

EPDP Team Recommendation #11. [Awaiting legal guidance]
 [[[The EPDP Team recommends that redaction must be applied as follows to this data element:

Data Element	Redacted
Registrant Field	
<ul style="list-style-type: none"> • City 	Yes ¹⁸]]]

EPDP Team Recommendation #12.

The EPDP Team recommends that:

- The Organization field will be published if that publication is acknowledged or confirmed by the registrant via a process that can be determined by each registrar. If the registered name holder does not confirm the publication, the Organization field can be redacted or the field contents deleted at the option of the registrar.
- The implementation will have a phase-in period to allow registrars the time to deal with existing registrations and develop procedures.
- In the meantime, registrars will be permitted to redact the Organization Field.
- A registry Operator, where they believe it feasible to do so, may publish or redact the Org Field in the RDDS output.

Implementation advice: the implementation review team should consider the following implementation model discussed by the EPDP Team:

For existing registrations, the first step will be to confirm the correctness / accuracy of the existing Organization field data.

For the period between the adoption of EPDP policy recommendations and some future “date certain” to be determined by the implementation review:

¹⁸ The IPC, GAC and BC indicated that they do not support this recommendation for redacting the city field.

- 1) Registrars will redact the Organization field
- 2) Registrars will contact the registered name holders that have entered data in the Organization field and request review and confirmation that the data is correct.
 - a) If the registered name holder confirms or corrects the data will remain in the Organization field.
 - b) If the registrant declines, or does not respond to the query, the Registrar may redact the Organization field, or delete the field contents. If necessary, the registration will be re-assigned to the Registered Name Holder.
- 3) If Registrar chooses to publish the Registrant Organization field, it will notify these registered name holders that of the “date certain,” the Organization field will be treated as non-personal data and be published, for those Registered Names Holders who have confirmed the data and agreed to publication.

For new registrations, beginning with the “date certain”:

- 1) New registrations will present some disclosure, disclaimer or confirmation when data is entered in the Organization field. Registrars are free to develop their own process (e.g., opt-in, pop-up advisory or question, locked/grayed out field).
- 2) If the registered name holder confirms the data and agrees to publication:
 - a) The data in the Organization field will be published,
 - b) The Organization will be listed as the Registered Name Holder.
 - c) The name of the registered name holder (a natural person) will be listed as the point of contact at the Registrant Organization.

After the implementation phase-in period, the ORG FIELD will no longer be REDACTED by the registrar.

EPDP Team Recommendation #13.

- 1) The EPDP Team recommends that the Registrar **MUST** provide an email address or a web form to facilitate email communication with the relevant contact, but **MUST NOT** identify the contact email address or the contact itself, unless as per Recommendation X, the Registered Name Holder has provided consent for the publication of its email address.
- 2) The EPDP Team recommends Registrars **MUST** maintain Log Files, which shall not contain any Personal Information, and which shall contain confirmation that a relay of the communication between the requestor and the Registered Name Holder has occurred, not including the origin, recipient, or content of the message. Such records will be available to ICANN for compliance purposes, upon request. Nothing in this

recommendation should be construed to prevent the registrar from taking reasonable and appropriate action to prevent the abuse of the registrar contact process.¹⁹

EPDP Team Recommendation #14.

In the case of a domain name registration where an "affiliated"²⁰ privacy/proxy service used (e.g. where data associated with a natural person is masked), Registrar (and Registry where applicable) MUST include in the public RDDS and return in response to any query full non-personal RDDS data of the privacy/proxy service, which MAY also include the existing privacy/proxy pseudonymized email.

Formatted: Border: Box: (Single solid line, Auto, 0.5 pt Line width)

EPDP Team Recommendation #15. [\[Agreement in principle – awaiting sign off of latest language\]](#)

1. [\[\[\[In order to inform its Phase 2 deliberations, the EPDP team recommends that ICANN Org, as a matter of urgency, undertakes a review of all of its active processes and procedures so as to identify and document the instances in which personal data is requested from a registrar beyond the period of the 'life of the registration'. Retention periods for specific data elements should then be identified, documented, and relied upon to establish the required relevant and specific minimum data retention expectations for registrars. The EPDP Team recommends community members be invited to contribute to this data gathering exercise by providing input on other legitimate purposes for which different retention periods may be applicable.](#)
2. [In the interim, the EPDP team has recognized that the Transfer Dispute Resolution Policy \("TDRP"\) has been identified as having the longest justified retention period of one year and has therefore recommended registrars be required to retain only those data elements deemed necessary for the purposes of the TDRP, for a period of one year following the life of the registration plus six months to implement the deletion, i.e., 18 months. This retention is grounded on the stated policy stipulation within the TDRP that claims under the policy may only be raised for a period of 12 months after the alleged breach \(FN: see TDRP section 2.2\) of the Transfer Policy \(FN: see Section 1.15 of TDRP\). This retention period does not restrict the ability of registries and registrars to retain data elements provided in Recommendations 4 -7 for other purposes specified in Recommendation 1 for shorter periods.²¹](#)

¹⁹ Examples of abuse could include, but are not limited to, requestors purposely flooding the registrar's system with voluminous and invalid contact requests. This recommendation is not intended to prevent legitimate requests.

²⁰ As defined in the [Registrar Accreditation Agreement, Specification on Privacy and Proxy Registrations](#): "For any Proxy Service or Privacy Service offered by the Registrar or its Affiliates, including any of Registrar's or its Affiliates' P/P services distributed through Resellers, and used in connection with Registered Names Sponsored by the Registrar, the Registrar and its Affiliates".

²¹ [In Phase 2, the EPDP Team will work on identifying different retention periods for any other purposes, including the purposes identified in this Report.](#)

3. The EPDP team recognizes that Contracted Parties may have needs or requirements for different retention periods in line with local law or other requirements. The EPDP team notes that nothing in this recommendation, or in separate ICANN-mandated policy, prohibits contracted parties from setting their own retention periods, which may be longer or shorter than what is specified in ICANN policy.
4. The EPDP team recommends that ICANN Org review its current data retention waiver procedure²² to improve efficiency, request response times, and GDPR compliance, e.g., if a Registrar from a certain jurisdiction is successfully granted a data retention waiver, similarly-situated Registrars might apply the same waiver through a notice procedure and without having to produce a separate application.]]]

EPDP Team Recommendation #16.

The EPDP Team recommends that Registrars and Registry Operators are permitted to differentiate between registrants on a geographic basis, but are not obligated to do so.

EPDP Team Recommendation #17.

- 1) The EPDP Team recommends that the policy recommendations in this Final Report apply to all gTLD registrations, without requiring Registrars or registries to differentiate between registrations of legal and natural persons, although registrars and registries are permitted to make this distinction.
- 2) The EPDP Team recommends that as soon as possible ICANN Org undertakes a study, for which the terms of reference are developed in consultation with the community, that considers:
 - The feasibility and costs including both implementation and potential liability costs of differentiating between legal and natural persons;
 - Examples of industries or other organizations that have successfully differentiated between legal and natural persons;
 - Privacy risks to registered name holders of differentiating between legal and natural persons; and
 - Other potential risks (if any) to registrars and registries of not differentiating.
- 3) The EPDP Team will discuss the Legal vs. Natural issue in Phase 2. Depending on the timing of the research, its discussions may inform the scope of research and/or use its findings.

EPDP Team Recommendation #18. [Agreement in principle – awaiting sign off of latest language]

[[[The EPDP Team recommends that the current requirements in Sections 4.1 and 4.2 of Appendix A to the Temporary Specification in relation to access to non-public

Formatted: Highlight

Deleted: [[[These criteria are applicable to disclosure requests relating to civil claims. LEA requests will be handled according to applicable laws.]]] ¶

²² For avoidance of doubt, ICANN's data retention waiver procedure only applies to contracted parties who need to apply for shorter data retention periods. Contracted parties do not need to seek a waiver for longer retention periods for data retention under their own controllership.

registration data, upon expiration are replaced with the criteria below and finalized through the requirements set during the implementation stage, recognizing that work in Phase 2 on a system for Standardized Access to Non-Public Registration Data may further complement, revise, or supersede these requirements. In addition, the EPDP team recommends that when a system for Standardized Access to Non-Public Registration Data is developed, the need for a policy governing Reasonable [Requests for Lawful Disclosure](#) outside of that model will be required.

The EPDP Team recommends that the new policy will refer to “Reasonable [Requests for Lawful Disclosure of Non-Public Registration Data](#)” or “Reasonable [Requests for Lawful Disclosure](#)”, instead of ‘Reasonable Access’ and that Registrar and Registry Operator must process and respond to [Reasonable](#) Requests for Lawful Disclosure.

The basic criteria for Reasonable [Requests](#) Lawful Disclosure are as follows: First, a [Reasonable](#) Request for Lawful Disclosure must follow the format required by the Registrar or Registry Operator and provide the required information, which are to be finalized during the implementation phase (see below). Second, delivery of a properly-formed [Reasonable](#) Request for Lawful Disclosure to a Registrar or Registry Operator does NOT require automatic disclosure of information. Third, Registrars and Registry Operators will consider each request on its merits, including the asserted GDPR legal bases.

Registrars and Registry Operators must publish, in a publicly accessible section of their web-site, the mechanism and process for submitting [Reasonable](#) Requests for Lawful Disclosure. The mechanism and process should include information on the required format and content of requests, means of providing a response, and the anticipated timeline for responses.

The EPDP Team recommends that criteria for a Reasonable [Request for](#) Lawful Disclosure and the requirements for acknowledging receipt of a request and response to such request will be defined as part of the implementation of these policy recommendations but will include at a minimum:

• Minimum Information Required for [Reasonable](#) Requests for Lawful Disclosure:

- Identification of and information about the requestor (including, the nature/type of business entity or individual, Power of Attorney statements, where applicable and relevant);
- Information about the legal rights of the requestor and specific rationale and/or justification for the request, (e.g. What is the basis or reason for the request; Why is it necessary for the requestor to ask for this data?);
- Affirmation that the request is being made in good faith;
- A list of data elements requested by the requestor and why this data is limited to the need;

- Agreement to process lawfully any data received in response to the request.
- **Timeline & Criteria for Registrar and Registry Operator Responses:**
 - Response time for acknowledging receipt of a Reasonable Request for Lawful Disclosure. Without undue delay, but not more than two (2) business days from receipt, unless shown circumstances does not make this possible.
 - Requirements for what information responses should include. Responses where disclosure of data (in whole or in part) has been denied should include: rationale sufficient for the requestor to understand the reasons for the decision, including, for example, an analysis and explanation of how the balancing test was applied (if applicable).
 - Logs of Requests, Acknowledgements and Responses should be maintained in accordance with standard business recordation practices so that they are available to be produced as needed including, but not limited to, for audit purposes by ICANN Compliance;
 - Response time for a response to the requestor will occur without undue delay and in any event within [X business] days of receipt of the request. (A finalized time frame to be set during implementation.)
 - A separate timeline of [less than X business days] will be considered for the response to 'Urgent' Reasonable Disclosure Requests, those Requests for which evidence is supplied to show an immediate need for disclosure [time frame to be finalized and criteria set for Urgent requests during implementation].

The EPDP Team recommends that the above be implemented and further work on defining these criteria commences as needed and as soon as possible.]]]]

EPDP Team Recommendation #19. [Agreement in principle – awaiting final sign off on language]

]]]]The EPDP Team recommends that ICANN Org negotiates and enters into required data protection agreements, as appropriate, with the Contracted Parties. In addition to the legally required components of such agreement, the agreement shall specify the responsibilities of the respective parties for the processing activities as described therein. Indemnification clauses should ensure that the risk for certain data processing is borne, to the extent appropriate, by the parties that are involved in the processing. Due consideration should be given to the analysis carried out by the EPDP Team in its Final Report.]]]]

EPDP Team Recommendation #20. [Agreement in principle – awaiting final sign off on language]

]]]]During Phase 1 of its work, the EPDP Team documented the data processing activities and responsible parties associated with gTLD registration data. The EPDP Team, accordingly, recommends the inclusion of the data processing activities and responsible

parties, outlined below, to be confirmed and documented in the relevant data protection agreements, noting, however, this Recommendation may be affected by the finalization of the necessary agreements that would confirm and define the roles and responsibilities.^[11]

ICANN PURPOSE²³:		
As subject to Registry and Registrar terms, conditions and policies, and ICANN Consensus Policies:		
<ul style="list-style-type: none"> To establish the rights of a Registered Name Holder in a Registered Name; to ensure that a Registered Name Holder may exercise its rights in the use and disposition of the Registered Name; and To activate a registered name and allocate it to a Registered Name Holder. 		
Processing Activity	Responsible Party²⁴:	Lawful Basis²⁵:
Collection	ICANN Registrars Registries	6(1)(b) for Registrars 6(1)(f) for ICANN and Registries
Transmission from Rr to Ry	Registrars Registries	Certain data elements (domain name and nameservers) would be required to be disclosed. The lawful basis would be 6(1)b, should personal data be involved for Registrars and 6(1)(f) of the GDPR for Registries. For other data elements, Art. 6(1)(f) of the GDPR.
Disclosure	Registrars Registries	Certain data elements (domain name and nameservers) would be required to be transferred from the Registrar to Registry. The lawful basis

²³ The term ICANN Purpose is used to describe purposes for processing personal data that should be governed by ICANN Org via a Consensus Policy. Note there are additional purposes for processing personal data, which the contracted parties might pursue, but these are outside of what ICANN and its community should develop policy on or contractually enforce. It does not necessarily mean that such purpose is solely pursued by ICANN org.

²⁴ Note, the responsible party is not necessarily the party carrying out the processing activity. This applies to all references of 'responsible party' in these tables.

²⁵ In relation to the application of 6(1)b, please see input provided by external legal counsel in relation to charter questions k, l and m above.

Data Retention		would be 6(1)b, should personal data be involved, for Registrars and 6 (1)(f) of the GDPR for Registries. 6(1)(f)
	ICANN	6(1)(f)

ICANN PURPOSE:
Maintaining the security, stability and resiliency of the Domain Name System In accordance with ICANN’s mission through the enabling of lawful access for legitimate third-party interests to data elements collected for the other purposes identified herein.

<u>Processing Activity</u>	<u>Responsible Party:</u>	<u>Lawful Basis:</u>
Collection	ICANN Registrars Registries	6(1)(f)
Transmission from Rr to Ry	N/A	N/A
Disclosure	ICANN	6(1)(f)
Data Retention	ICANN	N/A

ICANN PURPOSE:
Enable communication with and/or notification to the Registered Name Holder and/or their delegated agents of technical and/or administrative issues with a Registered Name

<u>Processing Activity</u>	<u>Responsible Party:</u>	<u>Lawful Basis:</u>
Collection	Registrar Registries	6(1)(b) for Registrars 6(1)(f) for Registries
Transmission from Rr to Ry	ICANN Registries	6(1)(f)
Disclosure	TBD	
Data Retention	ICANN	N/A

ICANN PURPOSE:
Provide mechanisms for safeguarding Registered Name Holders' Registration Data in the event of a business or technical failure, or other unavailability of a Registrar or Registry Operator

<u>Processing Activity</u>	<u>Responsible Party:</u>	<u>Lawful Basis</u>
Collection	ICANN	6(1)(f)
Transmission from Rr to Ry	ICANN	6(1)(f)
Disclosure	ICANN	6(1)(f)
Data Retention	ICANN	6(1)(f)

ICANN PURPOSE:
Handle contractual compliance monitoring requests, audits, and complaints submitted by Registry Operators, Registrars, Registered Name Holders, and other Internet users.

<u>Processing Activity</u>	<u>Responsible Party:</u>	<u>Lawful Basis:</u>
Collection	ICANN	6(1)(f)
Transmission from Rr to Ry	ICANN	6(1)(f)
Disclosure	N/A	
Data Retention	ICANN	6(1)(f)

ICANN PURPOSE:
Coordinate, operationalize and facilitate policies for resolution of disputes regarding or relating to the registration of domain names (as opposed to the use of such domain names), namely, the UDRP, URS, PDDRP, RRDRP and future-developed domain name registration-related dispute procedures for which it is established that the processing of personal data is necessary

<u>Processing Activity</u>	<u>Responsible Party:</u>	<u>Lawful Basis:</u>
Collection	ICANN Registrars	6(1)(b) for Registrars 6(1)(f) for Registries
Transmission from Rr to Ry	ICANN Registries Registrars	6(1)(b) for Registrars 6(1)(f) for Registries

Transmission to dispute resolution providers	ICANN Registries Registrars Dispute Resolution Provider – Processor or independent controller	6(1)(b) for Registrars 6(1)(f) for Registries and ICANN
Disclosure		
Data Retention		

ICANN PURPOSE:		
Enabling validation to confirm that Registered Name Holder meets optional gTLD registration policy eligibility criteria voluntarily adopted by Registry Operator.		
Processing Activity	Responsible Party:	Lawful basis:
Collecting specific data for Registry Agreement-mandated eligibility requirements	Registries	6(1)(b) for Registrars 6(1)(f) for Registries
Collecting specific data for Registry Operator-adopted eligibility requirements	Registries	6(1)(b) for Registrars 6(1)(f) for Registries
Transmission from Rr to Ry RA-mandated eligibility requirements	Registries	6(1)(b) for Registrars 6(1)(f) for Registries
Transmission from Rr to Ry Registry-adopted eligibility requirements	Registries	6(1)(b) for Registrars 6(1)(f) for Registries
Disclosure	Registries	N/A

Deleted: 9 February 2019

Data Retention	Registries	6(1)(f)
-----------------------	------------	---------

Deleted: ¶
¶
¶

EPDP Team Recommendation #21.

The EPDP Team recommends that, for the new policy on gTLD registration data, the following requirements MUST apply in relation to URS and UDRP until such time as these are superseded by recommendations from the RPMs PDP WG and/or policies from the EPDP regarding disclosure:

Uniform Rapid Suspension (supplemental requirements for the 17 October 2013 URS High Level Technical Requirements for Registries and Registrars and URS Rules effective 28 June 2013)

(1) Registry Operator Requirement: The Registry Operator (or appointed BERO) MUST provide the URS provider with the full Registration Data for each of the specified domain names, upon the URS provider notifying the Registry Operator (or appointed BERO) of the existence of a complaint, or participate in another mechanism to provide the full Registration Data to the Provider as specified by ICANN. If the gTLD operates as a "thin" registry, the Registry Operator MUST provide the available Registration Data to the URS Provider.

(2) Registrar Requirement: If the domain name(s) subject to the complaint reside on a "thin" registry, the Registrar MUST provide the full Registration Data to the URS Provider upon notification of a complaint.

(3) URS Rules: Complainant's complaint will not be deemed defective for failure to provide the name of the Respondent (Registered Name Holder) and all other relevant contact information required by Section 3 of the URS Rules if such contact information of the Respondent is not available in registration data publicly available in RDDS or not otherwise known to Complainant. In such an event, Complainant may file a complaint against an unidentified Respondent and the Provider shall provide the Complainant with the relevant contact details of the Registered Name Holder after being presented with a complaint against an unidentified Respondent.

Uniform Dispute Resolution Policy (supplemental requirements for the Rules for Uniform Domain Name Dispute Resolution Policy (the "Rules"))

(1) Registrar Requirement: The Registrar MUST provide the UDRP provider with the full Registration Data for each of the specified domain names, upon the UDRP provider notifying the Registrar of the existence of a complaint, or participate in another mechanism to provide the full Registration Data to the Provider as specified by ICANN.

(2) Complainant's complaint will not be deemed defective for failure to provide the name of the Respondent (Registered Name Holder) and all other relevant contact information required by Section 3 of the UDRP Rules if such contact information of the Respondent is not available in registration data publicly available in RDDS or not otherwise known to Complainant. In such an event, Complainant may file a complaint

against an unidentified Respondent and the Provider shall provide the Complainant with the] relevant contact details of the Registered Name Holder after being presented with a complaint against an unidentified Respondent.

EPDP Team Recommendation #22.

The EPDP Team also recommends that the GNSO Council instructs the review of all RPMs PDP WG to consider, as part of its deliberations, whether there is a need to update existing requirements to clarify that a complainant must only be required to insert the publicly-available RDDS data for the domain name(s) at issue in its initial complaint. The EPDP Team also recommends the GNSO Council to instruct the RPMs PDP WG to consider whether upon receiving updated RDDS data (if any), the complainant must be given the opportunity to file an amended complaint containing the updated respondent information.

EPDP Team Recommendation #23.

The EPDP Team recommends that ICANN Org must enter into appropriate data protection agreements with dispute resolution providers in which, amongst other items, the data retention period is specifically addressed.

EPDP Team Recommendation #24.

The EPDP Team recommends that for the new policy on gTLD registration data, the following requirements MUST apply in relation to the Transfer Policy until such time these are superseded by recommendations that may come out of the Transfer Policy review that is being undertaken by the GNSO Council:

Supplemental procedures for the [Transfer Policy](#) applicable to all ICANN-accredited Registrars

(a) Until such time when the RDAP service (or other secure methods for transferring data) is required by ICANN to be offered, if the Gaining Registrar is unable to gain access to then-current Registration Data for a domain name subject of a transfer, the related requirements in the Transfer Policy will be superseded by the below provisions:

(a1) The Gaining Registrar is not REQUIRED to obtain a Form of Authorization from the Transfer Contact.

(a2) The Registrant MUST independently re-enter Registration Data with the Gaining Registrar. In such instance, the Gaining Registrar is not REQUIRED to follow the Change of Registrant Process as provided in Section II.C. of the Transfer Policy.

(b) As used in the Transfer Policy:

(b1) The term "Whois data" SHALL have the same meaning as "Registration Data".

(b2) The term "Whois details" SHALL have the same meaning as "Registration Data".

(b3) The term "Publicly accessible Whois" SHALL have the same meaning as "RDDS".

(b4) The term "Whois" SHALL have the same meaning as "RDDS".

Deleted: 9 February 2019

(c) Registrar and Registry Operator SHALL follow best practices in generating and updating the "AuthInfo" code to facilitate a secure transfer process.

(d) Registry Operator MUST verify that the "AuthInfo" code provided by the Gaining Registrar is valid in order to accept an inter-registrar transfer request.

EPDP Team Recommendation #25.

The EPDP Team recommends that the GNSO Council, as part of its review of the Transfer Policy, specifically requests the review of the implications, as well as adjustments, that may be needed to the Transfer Policy as a result of GDPR, with great urgency.

EPDP Team Recommendation #26.

The EPDP Team recommends that ICANN Org enters into required data processing agreements such as a Data Processing Agreement (GDPR Art. 28) or Joint Controller Agreement (Art. 26), as appropriate, with the non-Contracted Party entities involved in registration data processing such as data escrow providers and EBERO providers. These agreements are expected to set out the relationship obligations and instructions for data processing between the different parties.

EPDP Team Recommendation #27.

The EPDP Team recommends that as part of the implementation of these policy recommendations, updates are made to the following existing policies / procedures, and any others that may have been omitted, to ensure consistency with these policy recommendations as, for example, a number of these refer to administrative and/or technical contact which will no longer be required data elements:

- [Registry Registration Data Directory Services Consistent Labeling and Display Policy](#)
- [Thick WHOIS Transition Policy for .COM, .NET, .JOBS](#)
- [Rules for Uniform Domain Name Dispute Resolution Policy](#)
- [WHOIS Data Reminder Policy](#)
- [Transfer Policy](#)
- [Uniform Rapid Suspension System \(URS\) Rules](#)
- [Transfer Dispute Resolution Policy](#)

EPDP Team Recommendation #28. Agreement in principle – awaiting final sign off on language

[[[The EPDP Team recommends that the effective date of the gTLD Registration Data Policy shall be February 29, 2020. All gTLD Registry Operators and ICANN-accredited registrars will be required to comply with the gTLD Registration Data Policy as of that date. The EPDP Team recommends that until February 29, 2020, registries and registrars are required EITHER to comply with this gTLD Registration Data Policy OR continue to implement measures consistent with the Temporary Specification (as adopted by the ICANN Board on 17 May 2018, and expired on 25 May 2019). Registries and registrars

Deleted: []

Deleted: [[[]

Deleted: [[]

Deleted: [[]

Deleted: [[]

Deleted: [[]

who continue to implement measures compliant with the expired Temporary Specification will not be subject to Compliance penalty specifically related to those measures until February 29, 2020.

The EPDP Team furthermore recommends that, as a matter of urgency, the GNSO Council and ICANN Org, informally convene the Implementation Review Team to allow for the necessary planning to take place before ICANN Board consideration of this Final Report, following which the IRT would be formally convened. [III](#).

EPDP Team Recommendation #29.

Recognizing that in the case of some existing registrations, there may be an Administrative Contact but no or incomplete Registered Name Holder contact information, the EPDP team recommends that prior to eliminating Administrative Contact fields, all Registrars must ensure that each registration contains Registered Name Holder contact information.

2.2 Conclusions and Next Steps

This Final Report will be submitted to the GNSO Council for its consideration and approval.

2.3 Other Relevant Sections of this Report

This Final Report also includes:

- Background of the issue, documenting how the Board adopted the Temporary Specification and the required procedures accompanying that adoption;
- Documentation of participation in the EPDP Team's deliberations, attendance records, and links to Statements of Interest;
- An annex that includes the EPDP Team's mandate as defined in the Charter adopted by the GNSO Council and;
- Information concerning community input obtained through formal SO/AC and SG/C channels as well as the publication of the Initial Report for public comment, including the input provided.

3 EPDP Team Approach

This Section provides a summary overview of the EPDP Team’s working methodology and approach.

3.1 Working Methodology

The EPDP Team began its deliberations on [1 August 2018](#). It worked primarily through conference calls scheduled two or more times per week, in addition to email exchanges on its mailing list. Additionally, the EPDP Team held three face-to-face meetings; one at the ICANN headquarters in Los Angeles in September 2018; one at the ICANN 63 Public Meeting in Barcelona in October 2018; and a third in Toronto in January 2019. The EPDP Team’s wiki [workspace documents its meetings](#), including its [mailing list](#), draft documents, background materials, and input received from ICANN’s SO/ACs including the GNSO’s Stakeholder Groups and Constituencies.

The EPDP Team also prepared a Work Plan, which was reviewed and updated on a regular basis, and a template to (i) tabulate Constituency and Stakeholder Group statements (see Annex B); and (ii) input from other ICANN SOs/ACs and individual EPDP Team members (see Annex B). This template was also used to record input from other ICANN Supporting Organizations and Advisory Committees, as well as individual EPDP Team members’ responses (either on their own behalf or as representatives of their respective groups) which can be found in Annex C.

The EPDP Team held a [community session](#) at the ICANN63 Public Meeting in Barcelona, to present its methodologies and preliminary findings to the broader ICANN community for discussion and feedback.

3.2 Initial Fact-Finding and Triage

The EPDP Team Charter required the team to review a list of topics and questions, as part of its work to develop policy recommendations relating to the Temporary Specification. These topics and questions were derived in large part from the prior work of the [EPDP Drafting Team](#), comprised of GNSO Councilors.

The EPDP Team’s first deliverable under its charter was a “triage” document of the Temporary Specification to identify items that had Full Consensus support of the EPDP Team, and should be adopted as is (without further discussion or modifications).

The Triage report disclosed few areas where the EPDP Team agreed with the Temporary Specification language. However, there were several areas of agreement with the underlying principles in several sections of the Temporary Specification. Where a constituency / stakeholder group / advisory committee did indicate support for a certain section of the

Temporary Specification, edits were often also suggested, meaning that essentially no section of the Temporary Specification will be adopted without modifications.

The Triage report and the surveys and discussions that formed the basis for the Triage report informed the EPDP Team's work on the Initial Report:

1. EPDP Team members' comments suggested sequencing of topics, which improved efficiency.
2. EPDP Team members' rationales in support of/opposition to each section narrowed the discussion to particular issues and suggested proposed modifications.
3. The EPDP Team compiled a library of each group's positions on a variety of topics, including outstanding issues to be discussed in the course of the Team's deliberations.

The Triage Report as well as input received can be found here:

<https://community.icann.org/x/jxBpBQ>.

3.3 Discussion Summary Indexes

The Triage Report resulted in the Support Team's development of the Discussion Summary Indexes to combine all input received into one standard document, allowing the EPDP Team to prepare for meeting deliberations with the same set of information. The Discussion Summary Indexes included: (i) the relevant Charter Questions mapped to the Temporary Specification; (ii) relevant input received in response to the triage surveys, (iii) early input and (iv) advice provided by the European Data Protection Board (EDPB). The Discussion Summary Indexes can be found here: <https://community.icann.org/x/ExxpBQ>.

3.4 Data Elements Workbooks

The EPDP Team realized the need to review each of the data elements collected, the purpose for its processing, and the legal basis for that data processing. This work resulted in the creation of the Data Elements Workbooks, which bring together purpose, data elements, processing activities, lawful basis for processing and responsible parties. For the Data Element Workbook for each purpose identified by the EPDP Team, see Annex D.

3.5 Small Teams

The EPDP Team worked in small teams to develop proposed consensus positions for the entire team to consider. The EPDP Team used small teams before the Initial Report to explore overarching Charter issues, develop proposed answers to Charter Questions, and formulate preliminary recommendations for review by the full EPDP Team. The small teams covered three topics:

1. Legal and natural persons:
Should Contracted Parties be allowed or required to treat legal and natural persons differently, and what mechanism is needed to ensure reliable determination of status?
Is there a legal basis for Contracted Parties to treat legal and natural persons differently?
What are the risks associated with differentiation of registrant status as legal or natural persons across multiple jurisdictions? (See EDPB letter of 5 July 2018).
2. Geographic basis:
Should Registry Operators and Registrars (“Contracted Parties”) be permitted or required to differentiate between registrants on a geographic basis?
3. Temporary Specification and Reasonable Access
Should existing requirements in the Temporary Specification remain in place until a model for access is finalized?

The EPDP Team also utilized small teams to review and analyze the public comments received on its Initial Report.

This approach, including the resultant work products, form the basis for the EPDP Team’s responses to the Charter Questions and recommendations are in the next section of this Final Report.

3.6 Mediation Techniques

The EPDP Team worked in face-to-face meetings with certified mediators from the Consensus Building Institute (www.cbi.org), who were generally credited with positively impacting the timely development of consensus positions and keeping discussions on track.

3.7 Charter Questions

In addressing the Charter Questions, the EPDP Team considered (1) each group’s responses to the [triage surveys](#); (2) each group’s [Early Input](#) on specific charter questions; and (3) public comments on the Initial Report.

4 Public Comment on the EPDP Team Initial Report

4.1 Background

On 21 November 2018, the EPDP Team published its [Initial Report for public comment](#). The Initial Report outlined the core issues discussed, proposed responses to Charter Questions and accompanying preliminary recommendations.

The EPDP Team welcomed community feedback on any issue in the Initial Report; however, the EPDP Team particularly sought input on the following questions. In responding to the below questions, the Initial Report encouraged commenters to (1) consider GDPR compliance in all responses, (2) identify specific changes, and (3) provide a rationale for any requested change:

- Are the proposed purposes outlined in the Initial Report sufficiently specific and, if not, how do you propose to modify them? Should any purposes be added?
- Are the recommended data elements as listed in the Initial Report as required for registrar collection necessary for the purposes identified? If not, why not? Are any data elements missing that are necessary to achieve the purposes identified?
- Are there other data elements than those listed in the Initial Report that are required to be transferred between registrars and registries / escrow providers that are necessary to achieve the purposes identified?
- Are there other data elements than those listed in the Initial Report that are required to be transferred between registrars and registries / ICANN Compliance that are necessary to achieve the purposes identified? Are there identified data elements that are not required to be transferred between registrars and registries / ICANN Compliance and are not necessary to achieve the purposes identified?
- Should the EPDP Team consider any changes in the redaction of data elements, compared to what is recommended in the Initial Report?
- Should the EPDP Team consider any changes to the recommended data retention periods compared to those recommended in the Initial Report? Do you believe the justification for retaining data beyond the term of the domain name registration is sufficient? Why or why not?
- What other factors should the EPDP team consider about whether Contracted Parties should be permitted or required to differentiate between registrants on a geographic basis? Between natural and legal persons? Are there any other risks associated with differentiation of registrant status (as natural or legal person) or geographic location? If so, please identify those factors and/or risks and how they would affect possible recommendations. Should the community explore whether procedures would be feasible to accurately distinguish on a global scale whether registrants/contracted parties fall within jurisdiction of the GDPR or other data protection laws? Can the community point to existing examples of where such a

differentiation is already made and could it apply at a global scale for purposes of registration data?

- Should the EPDP Team consider any changes to its recommendations in relation to "reasonable access" as outlined in the Initial Report?
- Are there any changes that the EPDP Team should consider in relation to the URS and UDRP that have not already been identified in the Initial Report?
- Are there any changes that the EPDP Team should consider in relation to the Transfer Policy that have not already been identified Initial Report?

4.2 Input received

Due to the expedited nature of this EPDP, the public comment forum ran for 30 days. The EPDP Team used a Google form to facilitate review of public comments. Nine GNSO Stakeholder Groups, Constituencies and ICANN Advisory Committees, submitted comments in addition to thirty-three contributions from individuals or organizations. The input provided is at:

<https://docs.google.com/spreadsheets/d/1GUf86Ngo97g74wLyDmeBv8lGcUtjLJWjsEdxBXcYDD4/edit#gid=694919619>.

4.3 Review of public comments

To facilitate its review of the public comments, the EPDP Team developed a set of [public comment review tools](#) (PCRTs). Through the work of small teams, plenary sessions, and face-to-face time, the EPDP Team completed its review and assessment of the input provided and agreed on changes to be made to the recommendations and/or report.

5 EPDP Team Responses to Charter Questions & Recommendations

After reviewing the public comments on the Initial Report and updating the recommendations, the EPDP Team presents its recommendations for GNSO Council consideration. This Final Report states the level of consensus within the EPDP Team **achieved for the different recommendations. Unless indicated differently, recommendations have achieved full consensus / consensus of the EPDP Team [Note that the consensus call process has not been completed yet. As such, designations may change. See Annex E for further details.]**

Deleted: for

Formatted: Highlight

Deleted: each recommendation.

From the EPDP Team Charter:

“The EPDP Team is being chartered to determine if the Temporary Specification for gTLD Registration Data should become an ICANN Consensus Policy, as is or with modifications, while complying with the GDPR and other relevant privacy and data protection law. As part of this determination, the EPDP Team is, at a minimum, expected to consider the following elements of the Temporary Specification and answer the following charter questions. The EPDP Team shall consider what subsidiary recommendations it might make for future work by the GNSO which might be necessary to ensure relevant Consensus Policies, including those related to registration data, are reassessed to become consistent with applicable law”.

Part 1: Purposes for Processing Registration Data

Charter Question

- a) Purposes outlined in Sec. 4.4.1-4.4.13 of the Temporary Specification:
- a1) Are the purposes enumerated in the Temporary Specification valid and legitimate?
 - a2) Do those purposes have a corresponding legal basis?
 - a3) Should any of the purposes be eliminated or adjusted?
 - a4) Should any purposes be added?

EPDP Team considerations and deliberations in addressing the charter questions:

- The EPDP Team reviewed the feedback that the European Data Protection Board provided in relation to lawful purposes for processing personal data and took specific note of the following:

“Nevertheless, the EDPB considers it essential that a clear distinction be maintained between the different processing activities that take place in the context of WHOIS and the respective purposes pursued by the various stakeholders involved. There are processing activities determined by ICANN, for which ICANN, as well as the registrars and registries, require their own

legal basis and purpose, and then there are processing activities determined by third parties, which require their own legal basis and purpose. The EDPB therefore reiterates that ICANN should take care not to conflate its own purposes with the interests of third parties, nor with the lawful grounds of processing which may be applicable in a particular case.”²⁶

As well as,

“As expressed also in earlier correspondence with ICANN (including [this letter](#) of December 2017 and [this letter](#) of April 2018), WP29 expects ICANN to develop and implement a WHOIS model which will enable legitimate uses by relevant stakeholders, such as law enforcement, of personal data concerning registrants in compliance with the GDPR, without leading to an unlimited publication of those data.”²⁷

- The Discussion Summary Index for section 4.4 captures this input, and is at <https://community.icann.org/x/ExxpBQ>.
- The EPDP Team deliberated on the purposes listed in the Temporary Specification as a starting point, but reformulated the text and further specified the relevant lawful basis (if any) and the party/parties involved in the processing.
- “ICANN Purpose” is used to describe purposes for processing personal data that should be governed by ICANN Org via a Consensus Policy.
- Contracted parties might pursue additional purposes for processing personal data, but these are outside of what ICANN and its community should develop policy or contractually enforce. This does not necessarily mean that such purpose is solely pursued by ICANN Org, apart from purpose 2.

EPDP Team Recommendation #1.

The EPDP Team recommends that the following ICANN Purposes for processing gTLD Registration Data form the basis of the new ICANN policy:

2. a. In accordance with the relevant registry agreements and registrar accreditation agreements, activate a registered name and allocate it to the Registered Name Holder.
 - b. Subject to the Registry and Registrar Terms, Conditions and Policies and ICANN Consensus Policies:
 - (i) Establish the rights of a Registered Name Holder in a Registered Name; and

²⁶ See <https://www.icann.org/en/system/files/correspondence/jelinek-to-marby-05jul18-en.pdf>

²⁷ See https://edpb.europa.eu/news/news/2018/european-data-protection-board-endorsed-statement-wp29-icannwhois_en

- (ii) Ensure that a Registered Name Holder may exercise its right in the use, maintenance and disposition of the Registered Name.;
8. Contributing to the maintenance of the security, stability, and resiliency of the Domain Name System in accordance with ICANN's mission through enabling responses to lawful data disclosure requests.²⁸
 9. Enable communication with the Registered Name Holder on matters relating to the Registered Name;
 10. Provide mechanisms for safeguarding Registered Name Holders' Registration Data in the event of a business or technical failure of a Registrar or Registry Operator, or unavailability of a Registrar or Registry Operator, as described in the RAA and RA, respectively;
 11. i) Handle contractual compliance monitoring requests and audit activities consistent with the terms of the Registry agreement and the Registrar accreditation agreements and any applicable data processing agreements, by processing specific data only as necessary;
ii) Handle compliance complaints initiated by ICANN, or third parties consistent with the terms of the Registry agreement and the Registrar accreditation agreements.
 12. Operationalize policies for the resolution of disputes regarding or relating to the registration of domain names (as opposed to the use of such domain names, but including where such policies take into account use of the domain names), namely, the UDRP, URS, PDDRP, RRDRP, and the TDRP; and
 13. Enabling validation to confirm that Registered Name Holder meets gTLD registration policy eligibility criteria voluntarily adopted by Registry Operator and that are described or referenced in the Registry Agreement for that gTLD.²⁹

Note that for each of these purposes, the EPDP Team has also identified: (i) the related processing activities; (ii) the corresponding lawful basis for each processing activity; and (iii) the data controllers and processors involved in each processing activity. For more information regarding the above, please refer to the Data Elements Workbooks which can be found in Annex D.

Note that Purpose 2 is a placeholder pending further work on the issue of access in Phase 2 of this EPDP and is expected to be revisited once this Phase 2 work has been completed.

Note that updates have been made to the data elements workbooks for purpose 6 to clarify that the WHOIS Accuracy Reporting System (ARS) is considered covered as part of that purpose.

- The EPDP Team considered an additional purpose for processing registration data to address the needs and benefits provided by DNS security and stability research by

²⁸ Purpose 2 should not preclude disclosure in the course of investigating intellectual property infringement.

²⁹ The EPDP Team's approval of Purpose 7 does not prevent and should not be interpreted as preventing Registry Operators from voluntarily adopting gTLD registration policy eligibility criteria that are not described or referenced in their respective Registry Agreements.

ICANN Org through investigation, research and publication of reports on threats to the operational stability, reliability, security, global interoperability, resilience, and openness of the DNS.

In doing so, the EPDP Team considered:

- input provided by ICANN Org on the current use of data by ICANN's Office of the Chief Technology Officer (OCTO) (see <https://community.icann.org/x/ahppBQ>), and
- relevant GDPR provisions that allow the use of personal data to carry out research, provided that other GDPR requirements are met.

In its input, OCTO stated it "does not require personal data in domain name registration data for its work. For example, OCTO's Domain Abuse Activity Reporting (DAAR) project <<https://www.icann.org/octo-ssr/daar>> uses only the registrar and nameserver information."

The discussion led to the preliminary conclusion that it was clear that OCTO does not at this time require the use of personal data in its work.

However, questions remained as to whether OCTO may require the use of pseudonymized data in the future in order to carry out its work. If this is the case, clarification may be required as to:

- how GDPR provisions would apply to ICANN Org given its multiple roles as data controller and processor and also the fact that ICANN Org currently does not collect the data; and
- whether ICANN Org could qualify for processing pseudonymized data for research purposes under some existing purpose for processing data listed above in this report.

Therefore, the EPDP Team recognized that additional consideration can be given to this topic once the questions above regarding the need for pseudonymized data and legal interpretation are answered. As a result, the EPDP Team is putting forward the following recommendation, recognizing that legal guidance received in the interim could make it no longer relevant.

EPDP Team Recommendation #2.

|||The EPDP Team commits to considering in Phase 2 of its work whether additional purposes should be considered to facilitate ICANN's Office of the Chief Technology Officer (OCTO) to carry out its mission (see <https://www.icann.org/octo>). This consideration should be informed by legal guidance on if/how provisions in the GDPR concerning research apply to ICANN Org and the expression for the need of such pseudonymized data by ICANN. |||

EPDP Team Recommendation #3.

In accordance with the EPDP Team Charter and in line with Purpose #2, the EPDP Team undertakes to make a recommendation pertaining to a standardised model for lawful disclosure of non-public Registration Data (referred to in the Charter as 'Standardised Access') now that the gating questions in the charter have been answered. This will include addressing questions such as:

- Whether such a system should be adopted
- What are the legitimate purposes for third parties to access registration data?
- What are the eligibility criteria for access to non-public Registration data?
- Do those parties/groups consist of different types of third-party requestors?
- What data elements should each user/party have access to?

In this context, the EPDP team will consider amongst other issues, disclosure in the course of intellectual property infringement and DNS abuse cases.³⁰

There is a need to confirm that disclosure for legitimate purposes is not incompatible with the purposes for which such data has been collected.

EPDP Team Recommendation #4.

The EPDP Team recommends that requirements related to the accuracy of registration data under the current ICANN contracts and consensus policies shall not be affected by this policy.³¹

Part 2: Required Data Processing Activities

Charter Question

b) Collection of registration data by registrar:

- b1) What data should registrars be required to collect for each of the following contacts: Registrant, Tech, Admin, Billing?
- b2) What data is collected because it is necessary to deliver the service of fulfilling a domain registration, versus other legitimate purpose as outlined in part (A) above?
- b3) How shall legitimacy of collecting data be defined (at least for personal data collected from European registrants and others in jurisdictions with data protection law)?

³⁰ The EPDP recognizes that ICANN has a responsibility to foster the openness, interoperability, resilience, security and/or stability of the DNS in accordance with its stated mission (citation required). It may have a purpose to require actors in the ecosystem to respond to data disclosure requests that are related to the security, stability and resilience of the system. The proposed Purpose 2 in this report is a placeholder, pending further legal analysis of the controller/joint controller relationship, and consultation with the EDPB. The EPDP recommends that further work be done in phase 2 on these issues, including a review of a limited purpose related to the enforcement of contracted party accountability for disclosure of personal data to legitimate requests.

³¹ The topic of accuracy as related to GDPR compliance is expected to be considered further as well as the WHOIS Accuracy Reporting System.

b4) Under the purposes identified in Section A, is there legal justification for collection of these data elements, or a legal reason why registrars should not continue to collect all data elements for each contact?

EPDP Team considerations and deliberations in addressing the charter questions:

- The EPDP Team considered both the input provided by each group in response to the triage surveys as well as the input provided by each group in response to the request for early input in relation to these questions.
- In addition, the EPDP Team reviewed the feedback from the European Data Protection Board related to the collection of registration data and took specific note of the following:

“The EDPB considers that registrants should in principle not be required to provide personal data directly identifying individual employees (or third parties) fulfilling the administrative or technical functions on behalf of the registrant. Instead, registrants should be provided with the option of providing contact details for persons other than themselves if they wish to delegate these functions and facilitate direct communication with the persons concerned. It should therefore be made clear, as part of the registration process, that the registrant is free to (1) designate the same person as the registrant (or its representative) as the administrative or technical contact; or (2) provide contact information which does not directly identify the administrative or technical contact person concerned (e.g. admin@company.com). For the avoidance of doubt, the EDPB recommends explicitly clarifying this within future updates of the Temporary Specification³²”.

- The EPDP Team also took note of a related footnote which states, “[if contact details for persons other than the RNH are provided] it should be ensured that the individual concerned is informed”. The EPDP Team discussed whether this note implies that it is sufficient for the Registered Name Holder (RNH) to inform the individual it has designated as the technical contact, or whether the registrar may have the additional legal obligations to obtain consent. The EPDP Team requested external legal counsel guidance on this topic and received the following summary answer:

“In cases where the RNH and the technical contact are not the same person, relying on the RNH to provide notice on the registrar's behalf will not meet GDPR's notice requirements if the RNH fails to provide the notice. While this may provide grounds for a contractual claim against the RNH, it is unlikely to provide a viable defence under the GDPR. Moreover, this arrangement will make it difficult for registrars to demonstrate that notice has been provided. If

³² See <https://www.icann.org/en/system/files/correspondence/jelinek-to-marby-05jul18-en.pdf>

notice is not effectively provided, this could affect the legitimate interests analysis, since technical contacts may not "reasonably expect" the manner in which their data will be processed. If relying on consent, such an arrangement would make it difficult to document that consent has been provided"³³.

- Noting some of the possible legal and technical challenges involved in collecting data from a third party, some (RySG, RrSG, NCSG) expressed the view that registrars should have the option, but should not be contractually required, to offer the RNH the ability to provide additional contact fields, e.g., technical function. Others (BC, IPC, ALAC, GAC and SSAC) expressed the view that registrars should be required to offer the RNH this ability, as making this optional could ultimately lead to risks to DNS stability, security and resiliency. The stakeholders supporting this view noted this functionality is considered important and desirable for some RNHs. The Team could not come to agreement on this issue and as such no recommendation is included in this Final Report in relation to whether optional also means, optional or required for the registrar to offer.
- All of the aforementioned input has been captured in the Discussion Summary Index for Appendix A which can be found here: <https://community.icann.org/x/ExxpBQ>.
- As a starting point, the EPDP examined data elements required to be collected today. The data elements workbooks in Annex D outline in detail which data elements are required to be collected for which purpose, and which data elements are optional for a Registered Name Holder to provide. Similarly, the data elements workbooks identify the applicable lawful basis. Processing activities identified as lawful under art. 6.1(b) are considered necessary for the performance of a contract (e.g., deliver the service of fulfilling a domain name registration).

EPDP Team Recommendation #5.

The EPDP Team recommends that the data elements listed below (as illustrated in the data elements workbooks in Annex D) are required to be collected by registrars. In the aggregate, this means that the following data elements are to be collected³⁴ where some data elements are automatically generated and, as indicated below, in some cases it is optional for the registered name holder to provide those data elements:

Data Elements (Collected & Generated ³⁵)
Domain Name
Registrar Whois Server*
Registrar URL*
Updated Date*

³³ For further details, please see <https://mm.icann.org/pipermail/gnso-epdp-legal/2019-January/000034.html>.

³⁴ For those data elements marked as "(optional)", these are optional for the RNH to provide.

³⁵ Data Elements indicated with * are generated either by the Registrar or the Registry

Registrar Registration Expiration Date*
Registrar*
Registrar IANA ID*
Registrar Abuse Contact Email*
Registrar Abuse Contact Phone*
Reseller*
Domain Status(es)*
Registrant Fields
• Name
• Organization (opt.)
• Street
• City
• State/province
• Postal code
• Country
• Phone
• Phone ext (opt.)
• Fax (opt.)
• Fax ext (opt.)
• Email
Tech Fields
• Name
• Phone
• Email
Name Server
DNSSEC
Name Server IP Address
Last Update of Whois Database*
• Additional data elements as identified by Registry Operator in its registration policy, such as (i) status as Registry Operator Affiliate or Trademark Licensee [.MICROSOFT]; (ii) membership in community [.ECO]; (iii) licensing, registration or appropriate permits (.PHARMACY, .LAW) place of domicile [.NYC]; (iv) business entity or activity [.BANK, .BOT]

For further details, see [complete data elements matrix](#).

For the purpose of the Technical contact, which is optional for the Registered Name Holder to complete (and if the Registrar provides this option), Registrars are to advise the Registered Name Holder at the time of registration that the Registered Name Holder is free

Field Code Changed

to (1) designate the same person as the registrant (or its representative) as the technical contact; or (2) provide contact information which does not directly identify the technical contact person concerned.

Note:

In its most recent deliberations, the EPDP Team:

- decided that it would be optional for the registered name holder to provide: technical contact name, email, and phone number
- did not reach agreement on whether it would be optional or required for the registrar to offer the ability to the Registered Name Holder to provide these data elements,

The following groups expressed support for requiring registrars to provide the option for the RNH to provide tech contact data: IPC, BC, ALAC, SSAC, and GAC. The following groups expressed support for leaving it optional for registrars to provide the option for the RNH to provide tech contact data: RrSG, RySG and NCSG).

Please see the data element workbooks in Annex D for further detail in relation to the meaning of optional in the context of the different data elements.

EPDP Team Recommendation #6.

The EPDP Team recommends that, as soon as commercially reasonable, Registrar must provide the opportunity for the Registered Name Holder to provide its Consent to publish additional contact information in the RDS for the sponsoring registrar.

Charter Question

- c) Transfer of data from registrar to registry:
- c1) What data should registrars be required to transfer to the registry?
 - c2) What data is required to fulfill the purpose of a registry registering and resolving a domain name?
 - c3) What data is transferred to the registry because it is necessary to deliver the service of fulfilling a domain registration versus other legitimate purposes as outlined in part (a) above?
 - c4) Is there a legal reason why registrars should not be required to transfer data to the registries, in accordance with previous consensus policy on this point?
 - c5) Should registries have the option to require contact data or not?
 - c6) Is there a valid purpose for the registrant contact data to be transferred to the registry, or should it continue to reside at the registrar?

EPDP Team considerations and deliberations in addressing the charter questions:

- For each of the Purposes for Processing Registration Data (above), the EPDP Team has identified where and which data is required to be transferred from the registrar to registry for the "Purposes" identified in response to charter question (a) as well as

the identified corresponding lawful basis. As an illustration, please see the data elements workbooks in Annex D of this report for further details. Those processing activities identified as having as a lawful basis under GDPR Art 6.1(b) were considered by the EPDP Team to be necessary for the performance of a contract, i.e., to deliver the service of fulfilling a domain registration.

- As part of this analysis, the EPDP Team has identified a set of data elements that are required to be transferred from the registrar to the registry in order to fulfill the Purposes for Processing Registration Data. This set of data elements constitutes an “aggregate minimum data set.” This is an aggregate minimum data set of all identified Purposes that registrars will be required to transfer to registries. This aggregate minimum data set also includes those data elements that MAY NOT be transferred from the registrar to the registry, where such a registry does not require such a transfer (with due regard to that registry’s terms, conditions, and policies).

EPDP Team Recommendation #7.

The EPDP Team recommends that the specifically-identified data elements under “[t]ransmission of registration data from Registrar to Registry”, as illustrated in the aggregate data elements workbooks, must be transferred from registrar to registry provided an appropriate legal basis exists and data processing agreement is in place. In the aggregate, these data elements are:

Data Elements (Collected & Generated ³⁶)
Domain Name
Registrar Whois Server*
Registrar URL*
Updated Date*
Registrar Registration Expiration Date*
Registrar*
Registrar IANA ID*
Registrar Abuse Contact Email*
Registrar Abuse Contact Phone*
Reseller*
Domain Status(es)*
Registrant Fields
<ul style="list-style-type: none"> • Name • Organization (opt.) • Street • City

³⁶ Data Elements indicated with * are generated either by the Registrar or the Registry

Deleted: 9 February 2019

• State/province
• Postal code
• Country
• Phone
• Phone ext (opt.)
• Fax (opt.)
• Fax ext (opt.)
• Email
Tech Fields
• Name
• Phone
• Email
Name Server
DNSSEC
Name Server IP Address
Last Update of Whois Database*
• Additional data elements as identified by Registry Operator in its registration policy, such as (i) status as Registry Operator Affiliate or Trademark Licensee [.MICROSOFT]; (ii) membership in community [.ECO]; (iii) licensing, registration or appropriate permits (.PHARMACY, .LAW) place of domicile [.NYC]; (iv) business entity or activity [.BANK, .BOT]

Deleted: Admin

For illustrative purposes, see [complete data elements matrix](#).

Field Code Changed

Charter Question

- d) Transfer of data from registrar/registry to data escrow provider:
 - d1) Should there be any changes made to the policy requiring registries and registrars to transfer the data that they process to the data escrow provider?
 - d2) Should there be any changes made to the procedures for transfer of data from a data escrow provider to ICANN Org?

EPDP Team considerations and deliberations in addressing the charter questions

- The EPDP Team considered both the input provided by each group in response to the triage surveys as well as the input provided by each group in response to the request for early input in relation to these questions.
- The EPDP Team considered Charter Question d1 and d2 in the context of the purpose to provide mechanisms for safeguarding Registered Name Holders' Registration Data and agreed that only data elements collected for other purposes identified herein and/or transferred from registrar to registry should be considered for escrow as those elements have been identified as necessary to meet the purpose.

Formatted: Bulleted + Level: 1 + Aligned at: 0.25" + Indent at: 0.5"

Deleted: ¶

EPDP Team Recommendation #8.

1. The EPDP Team recommends that ICANN Org develops legally-compliant data protection agreements with the data escrow providers.
2. The EPDP Team recommends updates to the contractual requirements for registries and registrars to transfer data that they process to the data escrow provider to ensure consistency with the data elements listed below (for illustrative purposes, see relevant workbooks in Annex D that analyze the purpose to provide mechanisms for safeguarding Registered Name Holders' Registration Data).
3. The data elements to be transferred by Registries and Registrars to data escrow providers are:

For registrars:

Data Elements (Collected & Generated ³⁷)
Domain Name
Registrar Registration Expiration Date*
Registrar*
Reseller*
Registrant Fields
<ul style="list-style-type: none"> • Name • Street • City • State/province • Postal code • Country • Phone • Email

For registries:

Data Elements (Collected & Generated ³⁸)
Domain Name
Registry Domain ID*

³⁷ Data Elements indicated with * are generated either by the Registrar or the Registry

³⁸ Data Elements indicated with * are generated either by the Registrar or the Registry

Registrar Whois Server*
Registrar URL*
Updated Date*
Creation Date*
Registry Expiry Date*
Registrar Registration Expiration Date*
Registrar*
Registrar IANA ID*
Registrar Abuse Contact Email*
Registrar Abuse Contact Phone*
Reseller*
Domain Status(es)*
Registry Registrant ID*
Registrant Fields
• Name
• Organization (opt.)
• Street
• City
• State/province
• Postal code
• Country
• Phone
• Phone ext (opt.)
• Fax (opt.)
• Fax ext (opt.)
• Email
Tech ID*
Tech Fields
• Name
• Phone
• Email
Name Server
DNSSEC
Name Server IP Address

- Additional data elements as identified by Registry Operator in its registration policy, such as (i) status as Registry Operator Affiliate or Trademark Licensee [.MICROSOFT]; (ii) membership in community [.ECO]; (iii) licensing, registration or appropriate permits (.PHARMACY, .LAW) place of domicile [.NYC]; (iv) business entity or activity [.BANK, .BOT]

Charter Question

- e) Transfer of data from registrar/registry to ICANN:
- e1) Should there be any changes made to the policy requiring registries and registrars to transfer the domain name registration data that they process to ICANN Compliance, when required/requested?

EPDP Team considerations and deliberations in addressing the charter questions

- The EPDP Team discussed current requirements as well as future needs in relation to contractual compliance and consulted with the ICANN Compliance Team.

EPDP Team Recommendation #9.

1. The EPDP Team recommends that updates are made to the contractual requirements concerning the registration data elements for registries and registrars to transfer to ICANN Org the domain name registration data that they process when required/requested for purpose 5 (Contractual Compliance), consistent with the data elements listed hereunder (for illustrative purposes, please see the workbook that analyzes the purpose to handle contractual compliance monitoring requests, audits, and complaints submitted by Registry Operators, Registrars, Registered Name Holders, and other Internet users in Annex D).
2. The EPDP Team recommends that the following data elements be transferred from registries and registrars to ICANN Org for purpose 5 (Contractual Compliance)³⁹:

Data Elements (Collected & Generated ⁴⁰)
Domain Name
Registry Domain ID*
Registrar Whois Server*

³⁹ To clarify, the data elements listed here are the aggregate of data elements that ICANN Compliance may request. As noted in the [Summary of ICANN Organization’s Contractual Compliance Team Data Processing Activities](#) “If the Contractual Compliance Team is unable to validate the issue(s) outlined in a complaint because the publicly available WHOIS data is redacted/masked, it will request the redacted/masked registration data directly from the contracted party (or its representative). In these instances, the Contractual Compliance Team will only request the redacted/masked data elements that are needed to validate the issue(s) outlined in the complaint”.

⁴⁰ Data Elements indicated with * are generated either by the Registrar or the Registry

Registrar URL*
Updated Date*
Creation Date*
Registry Expiry Date*
Registrar Registration Expiration Date*
Registrar*
Registrar IANA ID*
Registrar Abuse Contact Email*
Registrar Abuse Contact Phone*
Reseller*
Domain Status(es)*
Registry Registrant ID*
Registrant Fields
• Name
• Organization (opt.)
• Street
• City
• State/province
• Postal code
• Country
• Phone
• Phone ext (opt.)
• Fax (opt.)
• Fax ext (opt.)
• Email
Tech ID*
Tech Fields
• Name
• Phone
• Email
Name Server
DNSSEC
Name Server IP Address
Last Update of Whois Database*

Charter Question

f) Publication of data by registrar/registry:

f1) Should there be any changes made to registrant data that is required to be redacted? If so, what data should be published in a freely accessible directory?

- f2) Should standardized requirements on registrant contact mechanism be developed?
- f3) Under what circumstances should third parties be permitted to contact the registrant, and how should contact be facilitated in those circumstances?

EPDP Team considerations and deliberations in addressing the charter questions

- The EPDP Team discussed which data elements are to be published in a freely accessible directory and which data elements are to be redacted. As a starting point, the EPDP Team considered the existing data-redaction list in the Temporary Specification (see Appendix A of the Temporary Specification). Although many agreed with the treatment (redaction vs. publication) of data-elements under the Temporary Specification, there was some disagreement as to whether the following elements should be treated differently, to either be redacted (as some believe they could contain personally identifiable information) or, in the alternative published, as described in greater detail below:
 - Organization,
 - City, and
 - Email Address.
- However, following review of the public comments received and further deliberation, the EPDP Team agreed to the following:

EPDP Team Recommendation #10.

Requirements for processing personal data in public RDDS where processing is subject to GDPR: The EPDP Team recommends that redaction must be applied as follows to the data elements that are collected. Data elements neither redacted nor anonymized must appear via free public based query access⁴¹:

Data Elements	Redacted
Domain Name	No
Registrar Whois Server	No
Registrar URL	No
Updated Date	No
Creation Date	No
Registry Expiry Date	No
Registrar Registration Expiration Date	No
Registrar	No
Registrar IANA ID	No
Registrar Abuse Contact Email	No

⁴¹ As noted in the data elements workbooks, “a minimum public data set of registration data will be made available for query of gTLD second level domains in a freely accessible directory. Where a data element has been designated as non-public, it will be redacted”.

Data Elements	Redacted
Registrar Abuse Contact Phone	No
Reseller	No
Domain Status	No
Registry Registrant ID	Yes
Registrant Fields	
• Name	Yes
• Organization (opt.)	Yes/No ⁴²
• Street	Yes
• State/province	No
• Postal code	Yes
• Country	No
• Phone	Yes
• Email	Yes ⁴³
• Anonymized email / link to web form	No
Tech ID	Yes
Tech Fields	
• Name	Yes
• Phone	Yes
• Email	Yes ⁴⁴
• Anonymized email / link to web form	No
NameServer(s)	No
DNSSEC	No
Name Server IP Address	No
Last Update of Whois Database	No

The EPDP Team also confirms that Registry Operator and Registrar MAY apply the requirements outlined in this recommendation, as well as recommendation #12, #13, #14 and #15 (i) where it has a commercially reasonable purpose to do so, or (ii) where it is not technically feasible to limit application of these requirements.

⁴² See recommendation #13 for further details in relation to the publication of the Organization field.

⁴³ The EPDP Team recommends that the 17 May 2018 Temp Spec requirement that a Registrar MUST provide an email address or a web form to facilitate email communication with the relevant contact, but MUST NOT identify the contact email address or the contact itself, continue to be in effect. See also the related recommendation #14 .

⁴⁴ The EPDP Team recommends that the 17 May 2018 Temp Spec requirement that a Registrar MUST provide an email address or a web form to facilitate email communication with the relevant contact, but MUST NOT identify the contact email address or the contact itself, continue to be in effect. See also the related recommendation #14.

Deleted: 9 February 2019

EPDP Team Recommendation #11. [Awaiting legal guidance]
 [[[The EPDP Team recommends that redaction must be applied as follows to this data element:

Formatted: Highlight

Data Element	Redacted
Registrant Field	
<ul style="list-style-type: none"> • City 	Yes ⁴⁵]]]

EPDP Team Recommendation #12.

The EPDP Team recommends that:

- The Organization field will be published if that publication is acknowledged or confirmed by the registrant via a process that can be determined by each registrar. If the registered name holder does not confirm the publication, the Organization field can be redacted or the field contents deleted at the option of the registrar.
- The implementation will have a phase-in period to allow registrars the time to deal with existing registrations and develop procedures.
- In the meantime, registrars will be permitted to redact the Organization Field.
- A registry Operator, where they believe it feasible to do so, may publish or redact the Org Field in the RDDS output.

Implementation advice: the implementation review team should consider the following implementation model discussed by the EPDP Team:

For existing registrations, the first step will be to confirm the correctness / accuracy of the existing Organization field data.

For the period between the adoption of EPDP policy recommendations and some future “date certain” to be determined by the implementation review:

- 1) Registrars will redact the Organization field
- 2) Registrars will contact the registered name holders that have entered data in the Organization field and request review and confirmation that the data is correct.
 - a) If the registered name holder confirms or corrects the data will remain in the Organization field.
 - b) If the registrant declines, or does not respond to the query, the Registrar may redact the Organization field, or delete the field contents. If necessary, the registration will be re-assigned to the Registered Name Holder.
- 3) If Registrar chooses to publish the Registrant Organization field, it will notify these registered name holders that of the “date certain,” the Organization field will be treated

⁴⁵ The IPC, GAC and BC indicated that they do not support this recommendation for redacting the city field.

as non-personal data and be published, for those Registered Names Holders who have confirmed the data and agreed to publication.

For new registrations, beginning with the “date certain”:

- 1) New registrations will present some disclosure, disclaimer or confirmation when data is entered in the Organization field. Registrars are free to develop their own process (e.g., opt-in, pop-up advisory or question, locked/grayed out field).
- 2) If the registered name holder confirms the data and agrees to publication:
 - a) The data in the Organization field will be published,
 - b) The Organization will be listed as the Registered Name Holder.
 - c) The name of the registered name holder (a natural person) will be listed as the point of contact at the Registrant Organization.

After the implementation phase-in period, the ORG FIELD will no longer be REDACTED by the registrar.

EPDP Team Recommendation #13.

- 1) The EPDP Team recommends that the Registrar **MUST** provide an email address or a web form to facilitate email communication with the relevant contact, but **MUST NOT** identify the contact email address or the contact itself, unless as per Recommendation X, the Registered Name Holder has provided consent for the publication of its email address.
- 2) The EPDP Team recommends Registrars **MUST** maintain Log Files, which shall not contain any Personal Information, and which shall contain confirmation that a relay of the communication between the requestor and the Registered Name Holder has occurred, not including the origin, recipient, or content of the message. Such records will be available to ICANN for compliance purposes, upon request. Nothing in this recommendation should be construed to prevent the registrar from taking reasonable and appropriate action to prevent the abuse of the registrar contact process.⁴⁶

Note: in relation to 1), this matches the requirements in Section 2.5.1 of Appendix A to the Temporary Specification

Note: The EPDP notes operational difficulties having to do with contacting registered name holders through webforms (where there is no confirmation that the message sent was received) and pseudonymized email addresses. Therefore, the registrar cannot be reasonably expected to confirm, or attempt to confirm by any means, the receipt of any such relayed communication. The EPDP notes that the GNSO Council may choose to consider

⁴⁶ Examples of abuse could include, but are not limited to, requestors purposely flooding the registrar’s system with voluminous and invalid contact requests. This recommendation is not intended to prevent legitimate requests.

further work on a potential method for safely and reliably contacting registrants in cases where their email cannot be displayed.

Note: Recommendation 3 of the EPDP Team's Final Report specifically provides that the EPDP Team's work shall not affect the accuracy of registration data under the current ICANN contracts and consensus policies. Accordingly, registrars are still required to reverify a registered name holder's email address if the registrar receives information suggesting that the contact information is incorrect. This would include a bounced email notification or non-delivery notification message in response to a registrar-initiated communication. This requirement can be found in paragraph 4 of the Whois Accuracy Program Specification in the Registrar Accreditation Agreement.

EPDP Team Recommendation #14.

In the case of a domain name registration where an "affiliated"⁴⁷ privacy/proxy service used (e.g. where data associated with a natural person is masked), Registrar (and Registry where applicable) MUST include in the public RDDS and return in response to any query full non-personal RDDS data of the privacy/proxy service, which MAY also include the existing privacy/proxy pseudonymized email.

Charter Question

g) Data retention:

- g1) Should adjustments be made to the data retention requirement (life of the registration + 2 years)?
- g2) If not, are changes to the waiver process necessary?
- g3) In light of the EDPB letter of 5 July 2018, what is the justification for retaining registration data beyond the term of the domain name registration?

EPDP Team considerations and deliberations in addressing the charter questions

- In addition, the EPDP Team reviewed the feedback that the European Data Protection Board provided in relation to data retention and took specific note of the following:

“personal data shall be kept in a form which permits identification of data subjects for no longer than is necessary for the purposes for which the personal data are processed (article 5(2) GDPR). This is a matter which has already been addressed repeatedly by both the WP29 and the EDPS.¹⁹ It is for ICANN to determine the appropriate retention period, and it must be able to demonstrate why it is necessary to keep personal data for that period. So far

Deleted: Note: In response to the SSAC's feedback regarding verification of bounced email notifications, Recommendation 3 of the EPDP Team's Final Report specifically provides that the EPDP Team's work shall not affect the accuracy of registration data under the current ICANN contracts and consensus policies. Accordingly, registrars are still required to reverify a registered name holder's email address if the registrar receives information suggesting that the contact information is incorrect. This would include a bounced email notification or non-delivery notification message in response to a registrar-initiated communication. This requirement can be found in paragraph 4 of the Whois Accuracy Program Specification in the Registrar Accreditation Agreement. ¶

⁴⁷ As defined in the [Registrar Accreditation Agreement, Specification on Privacy and Proxy Registrations](#): “For any Proxy Service or Privacy Service offered by the Registrar or its Affiliates, including any of Registrar's or its Affiliates' P/P services distributed through Resellers, and used in connection with Registered Names Sponsored by the Registrar, the Registrar and its Affiliates”.

ICANN is yet to demonstrate why each of the personal data elements processed in the context of WHO IS must in fact be retained for a period of 2 years beyond the life of the domain name registration. The EDPB therefore reiterates the request ICANN to re-evaluate the proposed retention period of two years and to explicitly justify and document why it is necessary to retain personal data for this period in light of the purposes pursued⁴⁸.

- For each of the purposes, the EPDP Team has identified in the data elements workbooks in Annex D the desired data retention period, including a rationale for why data needs to be retained for that period.

EPDP Team Recommendation #15. Agreement in principle – awaiting final sign off of language

1. In order to inform its Phase 2 deliberations, the EPDP team recommends that ICANN Org, as a matter of urgency, undertakes a review of all of its active processes and procedures so as to identify and document the instances in which personal data is requested from a registrar beyond the period of the 'life of the registration'. Retention periods for specific data elements should then be identified, documented, and relied upon to establish the required relevant and specific minimum data retention expectations for registrars. The EPDP Team recommends community members be invited to contribute to this data gathering exercise by providing input on other legitimate purposes for which different retention periods may be applicable.
2. In the interim, the EPDP team has recognized that the Transfer Dispute Resolution Policy ("TDRP") has been identified as having the longest justified retention period of one year and has therefore recommended registrars be required to retain only those data elements deemed necessary for the purposes of the TDRP, for a period of one year following the life of the registration plus six months to implement the deletion, i.e., 18 months. This retention is grounded on the stated policy stipulation within the TDRP that claims under the policy may only be raised for a period of 12 months after the alleged breach (FN: see TDRP section 2.2) of the Transfer Policy (FN: see Section 1.15 of TDRP). This retention period does not restrict the ability of registries and registrars to retain data elements provided in Recommendations 4 -7 for other purposes specified in Recommendation 1 for shorter periods.⁴⁹
3. The EPDP team recognizes that Contracted Parties may have needs or requirements for different retention periods in line with local law or other requirements. The EPDP team notes that nothing in this recommendation, or in separate ICANN-mandated policy, prohibits contracted parties from setting their own retention periods, which may be longer or shorter than what is specified in ICANN policy.

⁴⁸ See <https://www.icann.org/en/system/files/correspondence/jelinek-to-marby-05jul18-en.pdf>

⁴⁹ In Phase 2, the EPDP Team will work on identifying different retention periods for any other purposes, including the purposes identified in this Report.

4. [The EPDP team recommends that ICANN Org review its current data retention waiver procedure⁵⁰ to improve efficiency, request response times, and GDPR compliance, e.g., if a Registrar from a certain jurisdiction is successfully granted a data retention waiver, similarly-situated Registrars might apply the same waiver through a notice procedure and without having to produce a separate application.,\]\]\]](#)

Charter Question

h) Applicability of Data Processing Requirements

- h1) Should Registry Operators and Registrars (“Contracted Parties”) be permitted or required to differentiate between registrants on a geographic basis?
 h2) Is there a legal basis for Contracted Parties to differentiate between registrants on a geographic basis?
 h3) Should Contracted Parties be allowed or required to treat legal and natural persons differently, and what mechanism is needed to ensure reliable determination of status?
 h4) Is there a legal basis for Contracted Parties to treat legal and natural persons differently?
 h5) What are the risks associated with differentiation of registrant status as legal or natural persons across multiple jurisdictions? (See EDPB letter of 5 July 2018).

EPDP Team considerations and deliberations in addressing the charter questions

- In relation to charter question h1, the EPDP Team agrees that contracted parties should be (and are) *permitted* to differentiate between registrants on a geographic basis; however, the EPDP Team members have divergent views on whether differentiation on a geographic basis should be required.
- The EPDP Team considered the public comment and developed the following thoughts in its deliberations in addressing the charter questions:
 - The EPDP Team discussed this extensively (as documented in the Initial Report) as well as in the context of the review on the public comments received on the Initial Report. In relation to part of charter question h1, the EPDP Team agrees that contracted parties should be (and are) permitted to differentiate between registrants on a geographic basis;
 - However, the EPDP Team members have divergent views on whether differentiation on a geographic basis should be required.
 - Recognizing that ICANN is a Data Controller in many scenarios and that ICANN may be considered “established” in Europe (within the meaning of the GDPR), the EPDP Team discussed whether those factors would have an effect upon the discussion and determining GDPR-compliant outcomes. It became clear that legal guidance in relation to the applicability of GDPR in the context

⁵⁰ For avoidance of doubt, ICANN’s data retention waiver procedure only applies to contracted parties who need to apply for shorter data retention periods. Contracted parties do not need to seek a waiver for longer retention periods for data retention under their own controllership.

Deleted: The EPDP team recommends that ICANN Org, as a matter of urgency and as soon as practicable, undertakes a review of all its active processes and procedures so as to identify and document the instances in which personal data is requested from a registrar beyond the period of the ‘life of the registration’. Retention periods for specific data elements should then be identified, documented, and relied upon to establish the required relevant and specific minimum data retention expectations for registrars. In addition, community members should be invited to contribute to this data gathering exercise by providing input on other legitimate purposes for which different retention purposes may be applicable. These contributions could help inform the deliberations foreseen during phase 2 of the EPDP Team’s work.

In the interim, the EPDP team has recognized that the Transfer Dispute Resolution Policy (“TDRP”) has been identified as having the longest justified retention period of one year and has therefore recommended registrars be required to retain only those data elements deemed necessary for the purposes of the TDRP, for a period of one year following the life of the registration. This retention is grounded on the stated policy stipulation within the TDRP that claims under the policy may only be raised for a period of 12 months after the alleged breach (FN: see TDRP section 2.2) of the Transfer Policy (FN: see Section 1.15 of TDRP). This retention period does not restrict the ability of registries and registrars to retain data elements provided in Recommendations 4 -7 for other purposes specified in Recommendation 1 for shorter periods.

The EPDP team recognizes that Contracted Parties may have needs or requirements for different retention periods in line with local law or other requirements. The EPDP team recommends that nothing in this recommendation, or in separate ICANN-mandated policy, should prohibit contracted parties from setting their own retention periods beyond that which is expected in ICANN policy. Similarly, should local law prevent retention for the minimum period as set by ICANN, the EPDP team recommends that a suitable waiver procedure is put in place that can address such situations. In addition, the waiver procedure should be reviewed to determine if it would be appropriate for other Contracted Parties to “join” themselves to an existing waiver upon demonstration of being subject to the same law or other requirement that grounded the original waiver application

- of ICANN having an ‘establishment’ in Europe could further inform requirements.
- The EPDP Team also discussed the possibility of developing a set of rules for guiding the making of geographical distinctions in an GDPR-compliant manner (akin to the EWG hypothesized “rules engine”). The Team agreed that creating this set of rules was a complex task (just as it would be for individual registrars) and agreed such development could not occur within the remit of this Phase I EPDP. Such a development would also be dependent on the response to the aforementioned legal guidance.
 - The EPDP Team discussed Charter Question h3, namely, should Contracted Parties be allowed or required to treat legal and natural persons differently, and what mechanism is needed to ensure reliable determination of status? In determining the answer to this question, the EPDP Team sought the guidance of external legal counsel, inquiring specifically, “If a registrar permits a registrant, at the time of domain name registration, to self-identify as a natural or legal person, does a registrant’s incorrect self-identification that results in the public display of personal data create liability under GDPR? If so, please advise, for each possible participant in the domain name registration process listed below, if that participant incurs liability.” External legal counsel provided the following summary answer:

“We conclude that the relevant parties could be subject to liability if a registrant wrongly self-identifies as a legal person (and not a natural person) and the registrant’s data is disclosed in reliance on this self-identification. To reduce the risks, we propose several solutions, such as focus group testing of the registration process to minimise the risk of errors and technical tools (if feasible) to verify the information provided. We also recommend providing clear notice to data subjects of the consequences for them of the designation as either a legal or a natural person as well as a way for data subjects to easily correct a mistaken classification. One way to do this effectively would be to send a follow-up email after registration to the listed contacts – this could also help with the notice issue addressed in question 1”⁵¹.

- Factoring in the different positions on these questions as outlined in the Initial Report and considering the input received to the questions outlined in the Initial Report, the EPDP Team is putting forward the following recommendations in response to the charter questions.

EPDP Team Recommendation #16.

The EPDP Team recommends that Registrars and Registry Operators are permitted to differentiate between registrants on a geographic basis, but are not obligated to do so.

⁵¹ For further details, see <https://mm.icann.org/pipermail/gnso-epdp-legal/2019-January/000034.html>

EPDP Team Recommendation #17.

- 1) The EPDP Team recommends that the policy recommendations in this Final Report apply to all gTLD registrations, without requiring Registrars or registries to differentiate between registrations of legal and natural persons, although registrars and registries are permitted to make this distinction.
- 2) The EPDP Team recommends that as soon as possible ICANN Org undertakes a study, for which the terms of reference are developed in consultation with the community, that considers:
 - The feasibility and costs including both implementation and potential liability costs of differentiating between legal and natural persons;
 - Examples of industries or other organizations that have successfully differentiated between legal and natural persons;
 - Privacy risks to registered name holders of differentiating between legal and natural persons; and
 - Other potential risks (if any) to registrars and registries of not differentiating.
- 3) The EPDP Team will discuss the Legal vs. Natural issue in Phase 2. Depending on the timing of the research, its discussions may inform the scope of research and/or use its findings.

- i) Transfer of data from registry to Emergency Back End Registry Operator (“EBERO”)
 - i1) Consider that in most EBERO transition scenarios, no data is actually transferred from a registry to an EBERO. Should this data processing activity be eliminated or adjusted?

EPDP Team considerations and deliberations in addressing the charter questions

- While most EBERO transition scenarios may not involve the transfer of registration data, the EPDP Team documented this processing activity in order to comprehensively account for all relevant processing activities. In reviewing processing activities associated with EBERO, the EPDP Team noted that the EBERO process invokes the registry escrow process. Specifically, Section 2.3 and Specification 2 of the Registry Agreement refer to the Escrow Format Specification, which specifically mentions “such as domains, contacts, name servers, etc[.]” The EPDP Team concluded that no other registration data is processed under other components of the EBERO process. Thus, a separate workbook specifically for EBERO was not created because the Registry Escrow purpose (see Workbook E-Ry) documents the transfer of data within the processing activities section of the workbook.

Charter Question

- j). Temporary Specification and Reasonable Access
 - j1) Should existing requirements in the Temporary Specification remain in place until a model for access is finalized?

1. If so:
 1. Under Section 4 of Appendix A of the Temporary Specification, what is meant by “reasonable access” to Non-Public data?
 2. What criteria must Contracted Parties be obligated to consider in deciding whether to disclose non-public Registration data to an outside party requestor (i.e. whether or not the legitimate interest of the outside party seeking disclosure are overridden by the interests or fundamental rights or freedoms of the registrant)?
2. If not:
 1. What framework(s) for disclosure could be used to address (i) issues involving abuse of domain name registrations, including but not limited to consumer protection, investigation of cybercrime, DNS abuse and intellectual property protection, (ii) addressing appropriate law enforcement needs, and (iii) provide access to registration data based on legitimate interests not outweighed by the fundamental rights of relevant data subjects?

j2) Can the obligation to provide “reasonable access” be further clarified and/or better defined through the implementation of a community-wide model for access or similar framework which takes into account at least the following elements:

 1. What outside parties / classes of outside parties, and types of uses of non-public Registration Data by such parties, fall within legitimate purposes and legal basis for such use?
 2. Should such outside parties / classes of outside parties be vetted by ICANN in some manner and if so, how?
 3. If the parties should not be vetted by ICANN, who should vet such parties?
 4. In addition to vetting the parties, either by ICANN or by some other body or bodies, what other safeguards should be considered to ensure disclosure of Non-Public Personal Data is not abused?
 - The intent of the recommendation hereunder is to provide clarity around the process and expectations of reasonable lawful disclosure in terms of making requests. The recommendation attempts to ensure that expectations are set for how to submit requests and in what fashion those requests will be handled once received. The Recommendation does NOT assume that disclosure will be made and, further, it is not contemplated how and on what basis a decision for disclosing (or not) will be made. Those issues are expected to be dealt with in Phase 2 of the EPDP Team’s work.

EPDP Team Recommendation #18. *Agreement in principle – awaiting final sign off on language.*
 [[[The EPDP Team recommends that the current requirements in Sections 4.1 and 4.2 of Appendix A to the Temporary Specification in relation to access to non-public registration data, upon expiration are replaced with the criteria below and finalized through the requirements set during the implementation stage, recognizing that work in Phase 2 on a system for Standardized Access to Non-Public Registration Data may further complement, revise, or supersede these requirements. In addition, the EPDP team recommends that when

Formatted: Highlight

Deleted: [[[These criteria are applicable to disclosure requests relating to civil claims. LEA requests will be handled according to applicable laws.]]] ¶

a system for Standardized Access to Non-Public Registration Data is developed, the need for a policy governing Reasonable [Requests for](#) Lawful Disclosure outside of that model will be required.

The EPDP Team recommends that the new policy will refer to “Reasonable [Requests for](#) Lawful Disclosure of Non-Public Registration Data” or “Reasonable [Requests for](#) Lawful Disclosure”, instead of ‘Reasonable Access’ and that Registrar and Registry Operator must process and respond to [Reasonable](#) Requests for Lawful Disclosure.

The basic criteria for Reasonable [Requests](#) Lawful Disclosure are as follows: First, a [Reasonable](#) Request for Lawful Disclosure must follow the format required by the Registrar or Registry Operator and provide the required information, which are to be finalized during the implementation phase (see below). Second, delivery of a properly-formed [Reasonable](#) Request for Lawful Disclosure to a Registrar or Registry Operator does NOT require automatic disclosure of information. Third, Registrars and Registry Operators will consider each request on its merits, including the asserted GDPR legal bases.

Deleted: 1

Registrars and Registry Operators must publish, in a publicly accessible section of their website, the mechanism and process for submitting [Reasonable](#) Requests for Lawful Disclosure. The mechanism and process should include information on the required format and content of requests, means of providing a response, and the anticipated timeline for responses.

The EPDP Team recommends that criteria for a Reasonable [Request for](#) Lawful Disclosure and the requirements for acknowledging receipt of a request and response to such request will be defined as part of the implementation of these policy recommendations but will include at a minimum:

● Minimum Information Required for [Reasonable](#) Requests for Lawful Disclosure:

- Identification of and information about the requestor (including, the nature/type of business entity or individual, Power of Attorney statements, where applicable and relevant);
- Information about the legal rights of the requestor and specific rationale and/or justification for the request, (e.g. What is the basis or reason for the request; Why is it necessary for the requestor to ask for this data?);
- Affirmation that the request is being made in good faith;
- A list of data elements requested by the requestor and why this data is limited to the need;
- Agreement to process lawfully any data received in response to the request.

● Timeline & Criteria for Registrar and Registry Operator Responses:

- Response time for acknowledging receipt of a Reasonable Request for Lawful Disclosure. Without undue delay, but not more than two (2) business days from receipt, unless shown circumstances does not make this possible.
- Requirements for what information responses should include. Responses where disclosure of data (in whole or in part) has been denied should include: rationale sufficient for the requestor to understand the reasons for the decision, including, for example, an analysis and explanation of how the balancing test was applied (if applicable).
- Logs of Requests, Acknowledgements and Responses should be maintained in accordance with standard business recordation practices so that they are available to be produced as needed including, but not limited to, for audit purposes by ICANN Compliance;
- Response time for a response to the requestor will occur without undue delay and in any event within [X business] days of receipt of the request. (A finalized time frame to be set during implementation.)
- A separate timeline of [less than X business days] will considered for the response to 'Urgent' Reasonable Disclosure Requests, those Requests for which evidence is supplied to show an immediate need for disclosure [time frame to be finalized and criteria set for Urgent requests during implementation].

The EPDP Team recommends that the above be implemented and further work on defining these criteria commences as needed and as soon as possible.^[11]

Part 3: Data Processing Terms

- k) ICANN's responsibilities in processing data
 - k1) For which data processing activities undertaken by registrars and registries as required by the Temporary Specification does ICANN determine the purpose and means of processing?
 - k2) In addition to any specific duties ICANN may have as data controller, what other obligations should be noted by this EPDP Team, including any duties to registrants that are unique and specific to ICANN's role as the administrator of policies and contracts governing gTLD domain names?
- l) Registrar's responsibilities in processing data
 - l1) For which data processing activities required by the Temporary Specification does the registrar determine the purpose and means of processing?
 - l2) Identify a data controller and data processor for each type of data.
 - l3) Which registrant data processing activities required by the Temporary Specification do registrars undertake solely at ICANN's direction?
 - l4) What are the registrar's responsibilities to the data subject with respect to data processing activities that are under ICANN's control?

m) Registry's responsibilities in processing data

- m1) For which data processing activities required by the Temporary Specification does the registry determine the purpose and means of processing?
- m2) Which data processing activities required by the Temporary Specification does the registry undertake solely at ICANN's direction?
- m3) Are there processing activities that registries may optionally pursue?
- m4) What are the registry's responsibilities to the data subject based on the above?

EPDP Team considerations and deliberations in addressing the charter questions

- Through its work on the data elements workbooks, the EPDP Team has identified for illustrative purposes the following for each of the purposes: (1) responsible party/parties, and (2) which party/parties is/are involved in the relevant processing steps, see Annex D.
- Some members of the EPDP Team considered whether the identification of Data Controllers & Processors or other recommendations in this report could have an impact on "No Third-Party Beneficiary" clauses in existing ICANN Contracted Party agreements and whether it should be made clear that this may not be the intention.
- The EPDP Team took note of the GDPR requirements and notes that in instances where the EPDP Team has classified ICANN as a Controller, ICANN would be expected to comply with the law. However, the EPDP Team is not recommending additional requirements for ICANN at this time.
- Similarly, the EPDP Team took note of the GDPR requirements and notes that in instances where the EPDP Team has classified Registries and Registrars as Controllers, or Processors, the Registry and/or Registrar would be expected to comply with the law. However, the EPDP Team is not recommending additional requirements for contracted parties at this time.
- The EPDP Team asked two questions about the application of Article 6(1)b to external legal counsel:
 - a) Does the reference 'to which the data subject is party' limit the use of this lawful basis only to those entities that have a direct contractual relationship with the Registered Name Holder?
 - b) Does "necessary for the performance of a contract" relate solely to the registration and activation of a domain, or, alternatively, could related activities such as fighting DNS abuse also be considered necessary for the performance of a contract?

External legal counsel provided the following summary answers:

"a) it is not clear if the contractual necessity condition can only apply where there is a contract between data controller and data subject, or whether the contract could be between another person and the data subject. (For example, so that ICANN or a registry could argue that their processing is necessary for the contract between the registrar and the RNH/data subject). In countries where we have checked, there are no cases on point. Some data protection authorities interpret the provision narrowly. However, there is also

guidance arguing for a more liberal approach. We think a more liberal approach is correct – but this is untested.

b) What is 'necessary' is interpreted strictly. We do not think that the EPDP could successfully argue that preventing DNS abuses is 'necessary' for the contract with the RNH. There is guidance from the Article 29 Working Party on this which has examples somewhat similar to ICANN's situation".⁵²

Processors, Controllers, Co-Controllers and Joint Controllers

Controller is the person or entity, that alone or jointly with others, determines the purpose and means of processing. Processing, in turn is *"any operation or set of operations which is performed on personal data or on sets of personal data, whether or not by automated means, such as collection, recording, organization, structuring, storage, adaptation or alteration, retrieval, consultation, use, disclosure by transmission, dissemination or otherwise making available, alignment or combination, restriction, erasure or destruction"*.

Pursuant to Art. 4 no. (7) GDPR "controller" means the natural or legal person, public authority, agency or other body which, **alone or jointly with others**, determines the purposes and means of the processing of personal data; where the purposes and means of such processing are determined by Union or Member State law, the controller or the specific criteria for its nomination may be provided for by Union or Member State law.

In situations where two or more controllers "jointly" determine the purposes and means of processing, Art. 26 GDPR specifies additional requirements that apply ("Joint Controller").

In contrast to controllers, processors do not have the right to make decisions with regard to the purposes and means of processing, but act for the contractor (controller) with a duty to comply with the controller(s)' instructions.

Processors can be afforded some discretion in deciding on the means of processor, whereas a determination of the purposes of processing is usually a function reserved to controllers.⁵³

The purpose of processing is an "expected result that is intended or guides planned actions". The means of processing is the "type and manner in which a result or objective is achieved"⁵⁴.

Processors are distinguished from [joint] controllers based on the following criteria:

⁵² For further details, please see <https://mm.icann.org/pipermail/gnso-epdp-legal/2019-January/000035.html>.

⁵³ *Klabundein Ehmman/Selmayr*, "Datenschutz-Grundverordnung" Art.4 marg. no. 29

⁵⁴ Art. 29 Data Protection Working Party, Statement 1/2010 of 16 February 2010, p. 16, available at http://ec.europa.eu/justice/policies/privacy/docs/wpdocs/2010/wp169_de.pdf

- A person or entity that has no legal or factual influence on the decision concerning the purposes for and manner in which personal data is processed cannot be a controller.
- A person or entity that alone or jointly with others decides on the purposes of processing is always a controller.
- The controller may also delegate the decision(s) concerning the means of processing to the processor, but the controller cannot delegate the “essential elements which are traditionally and inherently reserved to the determination of the controller, such as ‘which data shall be processed?’, ‘for how long shall they be processed?’ ‘who shall have access to them?’, and so on.”.
- Processors are independent legal persons who are different from the controller and who process data on behalf of the controller(s) without deciding on the purposes of processing.⁵⁵

Where two or more different organizations jointly determine the purposes or the essential elements of the means of the processing they will be joint controllers and must enter into an agreement as required by Art. 26 of the GDPR. The participation of the parties to the joint determination may take different forms and does not need to be equally shared. Jointly must interpreted “as meaning ‘together with’ or ‘not alone’ in different forms and combinations” and “the assessment of joint control should mirror the assessment of ‘single’ control”. Therefore, it cannot be assumed that ICANN and the contracted parties are co-controllers for the processing of data, rather than joint controllers. A co-controllership would require two or more parties which are completely independent of one another, co-operatively working together in the processing of data but for different purposes.

ICANN and the EPDP Charter Questions and How the Above Principles are Applied Herein

As discussed below, the processing of registration data is covered by the overarching purpose of the registration of a domain name by all three parties in this process.

Purpose of Art. 26 GDPR

The regulation is to primarily protect of the rights and freedoms of data subjects.⁵⁶ This document is intended to address the clear allocation of responsibilities in relation to ensure the rights of data subjects. In more complex role allocations, e.g. in the area of domain registration with several distribution levels, the data subject’s right of access and other rights are to be guaranteed across levels.⁵⁷

⁵⁵ Art. 29 Data Protection Working Party, Statement 1/2010 of 16 February 2010, p. 18, 39, 40, available at http://ec.europa.eu/justice/policies/privacy/docs/wpdocs/2010/wp169_de.pdf

⁵⁶ Bertmannin Ehmman/Selmayr “Datenschutz-Grundverordnung” Art. 26, marg. no. 1

⁵⁷ Art. 29 Data Protection Working Party, Statement 1/2010 of 16 February 2010, p. 27, available at http://ec.europa.eu/justice/policies/privacy/docs/wpdocs/2010/wp169_de.pdf

“The definition of the term “processing” listed in Article 2 lit. b of the guideline does not exclude the option that diverse actors participate in diverse operations or sets of operations in connection with personal data. These operations can be executed simultaneously or in diverse stages. In such a complex environment it is even more important that roles and responsibilities are allocated to ensure that the complexity of joint control does not result in an impractical division of responsibility that would affect the effectiveness of data protection law.”⁵⁸

Recital 79 GDPR furthermore clarifies that the regulation is to simplify monitoring by the supervisory authorities.

The factual control of the data processing, as well as control over external effects vis-à-vis the data subject, is determinative when reviewing responsibility.

Furthermore, processing should not be artificially divided into smaller processing steps, but can be uniformly considered as a set of operations. In this respect, data collection, passing on to the registry, review and implementation and ongoing management of the registration can be considered as one set of “domain registration” operations, because it pursues the overall purpose of registering the domain for a new registrant. This also applies if diverse agencies pursue different purposes within the processing chain, when engaged in the detail of smaller processing steps on a micro level. On a macro level, the same purpose is pursued overall with all small steps in the chain, so that a uniform set of operations specifically applies here (Art.29 Group WP 169, p. 25).

Differentiation is required when considering the operation of collecting and processing the data collected by the registrar from its customers in order to create an invoice, to maintain a customer account, and to manage the contractual relationship with its customers. This data fulfils another purpose that is not codetermined by the registry and ICANN.

Further analysis should be carried out to determine, for the table below, which processing activities are determined jointly and which are not.

This also corresponds to the legislative intent to have clear and simple regulations concerning responsibility in case of multiple participants and complex processing structures, and to prevent a splitting of responsibilities to protect the data subjects as far as possible.

Pursuant to Article 1 Section 1.1 of the ICANN bylaws, ICANN has responsibility:

“to ensure the stable and secure operation of the Internet's unique identifier systems as described in this Section 1.1(a) (the “Mission”). Specifically, ICANN:

(i) Coordinates the allocation and assignment of names in the root zone of the Domain Name System (“DNS”) and coordinates the development and implementation of policies concerning the registration of second-level domain names in generic top-

⁵⁸ Art. 29 Data Protection Working Party, Statement 1/2010 of 16 February 2010, p. 22, available at http://ec.europa.eu/justice/policies/privacy/docs/wpdocs/2010/wp169_de.pdf

level domains ("**gTLDs**"). In this role, ICANN's scope is to coordinate the development and implementation of policies:

- For which uniform or coordinated resolution is reasonably necessary to facilitate the openness, interoperability, resilience, security and/or stability of the DNS including, with respect to gTLD registrars and registries, policies in the areas described in Annex G-1 and Annex G-2;"

As already stated, ICANN fulfils this responsibility among other things by contractually specifying for the various participants the data which must mandatorily be collected and retained. With these legitimate provisions, ICANN specifies a purpose for the processing operation overall and thus becomes joint controller in addition to registry and registrar. It should be noted that ICANN's responsibility is unaffected by the fact that certain requirements have been decided upon by multiple stakeholders or have determined and put into effect through a community effort. Such joint discussion or drafting of certain policies or requirements does not place ICANN in a role as the entity ultimately requiring the contracted parties to act in accordance with the policies issued by ICANN.

Joint and several liability

Irrespective of joint control, if two or more controllers are involved in the "same" processing then there will be joint and several liability unless a party can provide it is not responsible for the event giving rise to the damage (Art. 82). The factual responsibility may be adjusted only *inter parties*. Therefore, having clear allocations between the parties is even more important *inter parties*.

Fines

However, such joint and multiple liability may not apply to fines under Art. 83 (4) lit. a) GDPR. In this respect, registry and registrar are liable pursuant to their role allocation for breaches in their area or against duties under the GDPR, which were incumbent upon them within the scope of the contractual basis.

Joint Controller Agreement

Joint controllers must furthermore specify, in a transparent form, who fulfills which duties vis-à-vis the data subjects, as well as who the contact point for data subject's rights is (Art. 26 (1) p. 2 GDPR).

However, the data subject is authorized to address any of the participating responsible agencies to assert its rights, regardless of the specification concerning competence (Art. 26 (3) GDPR).

The agreement is to regulate the specific controllers that are to fulfill the duties prescribed by GDPR. Pursuant to Recital 79 GDPR, the following must be specifically regulated in a transparent form:

- how the relations and functions of the controllers among each other are designed,
- how roles are distributed between controllers to fulfill data subject rights of registrants,

Article 26 permits the parties to allocate responsibility for providing notice to the party best able to fulfill the obligation. However, Art. 26 GDPR suggests that multiple controllers fulfill information obligations centrally. Details shall be agreed upon between the parties.

Therefore, in relation to the above, as described, the EPDP, has set forth within the Initial Report, the Responsibility of each named party in relation to the specified Purposes, listed and based on the legal basis recommendations, for the respective Purpose and in relation to its duties performed for the data subject.

In relation to Preliminary Recommendation #13 below, the EPDP Team understands that relationship between ICANN Org, Registries and Registrars requires work at a greater level of granularity than in this report. During the further work of the EPDP and negotiations that will subsequently take place between the Registries, Registrars and ICANN in relation to memorializing the relationship between the parties for various processing activities the parties shall conduct a detailed review of the individual processing activities and the actions to be taken by the respective parties to determine if there is joint control and the scope of any joint control; and b) (irrespective of joint control) to allocate responsibility. If there is joint control, then any agreement shall meet the requirements of Art. 26 sec 2 of the GDPR (including a document being made to data subjects), which specifies:

"The arrangement referred to in paragraph 1 shall duly reflect the respective roles and relationships of the joint controllers vis-à-vis the data subjects. The essence of the arrangement shall be made available to the data subject."

A clear demarcation the processing activities covered by the agreement versus those carried out by either party outside the scope of the agreement shall be documented.

The agreement shall recognize that parties are currently using third parties' services or otherwise work with third parties, such as

- Data Escrow Agents
- EBEROs
- Registry Service Providers
- Registrar as a Service Providers
- Resellers
- Dispute Resolution Providers
- the TMCH.

This may or may not include processing of personal data by those third parties. Where personal data is processed by third parties, the respective agreement will need to ensure that the data processing is carried out in a way compliant with GDPR. However, conditional to GDPR compliance, nothing in the agreement shall prevent the respective parties from engaging third parties and entering into the required agreements without further

authorizations from the other parties.

EPDP Team Recommendation #19.

The EPDP Team recommends that ICANN Org negotiates and enters into required data protection agreements, as appropriate, with the Contracted Parties. In addition to the legally required components of such agreement, the agreement shall specify the responsibilities of the respective parties for the processing activities as described therein. Indemnification clauses should ensure that the risk for certain data processing is borne, to the extent appropriate, by the parties that are involved in the processing. Due consideration should be given to the analysis carried out by the EPDP Team in its Final Report.

EPDP Team Recommendation #20.

During Phase 1 of its work, the EPDP Team documented the data processing activities and responsible parties associated with gTLD registration data. The EPDP Team, accordingly, recommends the inclusion of the data processing activities and responsible parties, outlined below, to be confirmed and documented in the relevant data protection agreements, noting, however, this Recommendation may be affected by the finalization of the necessary agreements that would confirm and define the roles and responsibilities.

ICANN PURPOSE⁵⁹:

As subject to Registry and Registrar terms, conditions and policies, and ICANN Consensus Policies:

- To establish the rights of a Registered Name Holder in a Registered Name; to ensure that a Registered Name Holder may exercise its rights in the use and disposition of the Registered Name; and
- To activate a registered name and allocate it to a Registered Name Holder.

Processing Activity	Responsible Party⁶⁰:	Lawful Basis⁶¹:
Collection	ICANN Registrars Registries	6(1)(b) for Registrars 6(1)(f) for ICANN and Registries
Transmission from Rr to Ry	Registrars Registries	Certain data elements (domain name and nameservers) would be required to be disclosed. The lawful basis would be

⁵⁹ The term ICANN Purpose is used to describe purposes for processing personal data that should be governed by ICANN Org via a Consensus Policy. Note there are additional purposes for processing personal data, which the contracted parties might pursue, but these are outside of what ICANN and its community should develop policy on or contractually enforce. It does not necessarily mean that such purpose is solely pursued by ICANN org.

⁶⁰ Note, the responsible party is not necessarily the party carrying out the processing activity. This applies to all references of 'responsible party' in these tables.

⁶¹ In relation to the application of 6(1)b, please see input provided by external legal counsel in relation to charter questions k, l and m above.

Disclosure		6(1)b, should personal data be involved for Registrars and 6 (1)(f) of the GDPR for Registries. For other data elements, Art. 6(1)(f) of the GDPR.
	Registrars Registries	Certain data elements (domain name and nameservers) would be required to be transferred from the Registrar to Registry. The lawful basis would be 6(1)b, should personal data be involved, for Registrars and 6 (1)(f) of the GDPR for Registries. 6(1)(f)
Data Retention	ICANN	6(1)(f)

ICANN PURPOSE:

Maintaining the security, stability and resiliency of the Domain Name System In accordance with ICANN’s mission through the enabling of lawful access for legitimate third-party interests to data elements collected for the other purposes identified herein.

Processing Activity	Responsible Party:	Lawful Basis:
Collection	ICANN Registrars Registries	6(1)(f)
Transmission from Rr to Ry	N/A	N/A
Disclosure	ICANN	6(1)(f)
Data Retention	ICANN	N/A

ICANN PURPOSE:

Enable communication with and/or notification to the Registered Name Holder and/or their delegated agents of technical and/or administrative issues with a Registered Name

<u>Processing Activity</u>	<u>Responsible Party:</u>	<u>Lawful Basis:</u>
Collection	Registrar Registries	6(1)(b) for Registrars 6(1)(f) for Registries
Transmission from Rr to Ry	ICANN Registries	6(1)(f)
Disclosure	TBD	
Data Retention	ICANN	N/A

ICANN PURPOSE:

Provide mechanisms for safeguarding Registered Name Holders' Registration Data in the event of a business or technical failure, or other unavailability of a Registrar or Registry Operator

<u>Processing Activity</u>	<u>Responsible Party:</u>	<u>Lawful Basis</u>
Collection	ICANN	6(1)(f)
Transmission from Rr to Ry	ICANN	6(1)(f)
Disclosure	ICANN	6(1)(f)
Data Retention	ICANN	6(1)(f)

ICANN PURPOSE:

Handle contractual compliance monitoring requests, audits, and complaints submitted by Registry Operators, Registrars, Registered Name Holders, and other Internet users.

<u>Processing Activity</u>	<u>Responsible Party:</u>	<u>Lawful Basis:</u>
Collection	ICANN	6(1)(f)
Transmission from Rr to Ry	ICANN	6(1)(f)
Disclosure	N/A	
Data Retention	ICANN	6(1)(f)

ICANN PURPOSE:

Coordinate, operationalize and facilitate policies for resolution of disputes regarding or relating to the registration of domain names (as opposed to the use of such domain names), namely, the UDRP, URS, PDDRP, RRDRP and future-developed

domain name registration-related dispute procedures for which it is established that the processing of personal data is necessary

<u>Processing Activity</u>	<u>Responsible Party:</u>	<u>Lawful Basis:</u>
Collection	ICANN Registrars	6(1)(b) for Registrars 6(1)(f) for Registries
Transmission from Rr to Ry	ICANN Registries Registrars	6(1)(b) for Registrars 6(1)(f) for Registries
Transmission to dispute resolution providers	ICANN Registries Registrars Dispute Resolution Provider – Processor or independent controller	6(1)(b) for Registrars 6(1)(f) for Registries and ICANN
Disclosure		
Data Retention		

ICANN PURPOSE:

Enabling validation to confirm that Registered Name Holder meets optional gTLD registration policy eligibility criteria voluntarily adopted by Registry Operator.

<u>Processing Activity</u>	<u>Responsible Party:</u>	<u>Lawful basis:</u>
Collecting specific data for Registry Agreement-mandated eligibility requirements	Registries	6(1)(b) for Registrars 6(1)(f) for Registries
Collecting specific data for Registry Operator-adopted eligibility requirements	Registries	6(1)(b) for Registrars 6(1)(f) for Registries
Transmission from Rr to Ry RA-mandated	Registries	6(1)(b) for Registrars 6(1)(f) for Registries

eligibility requirements		
Transmission from Rr to Ry Registry-adopted eligibility requirements	Registries	6(1)(b) for Registrars 6(1)(f) for Registries
Disclosure	Registries	N/A
Data Retention	Registries	6(1)(f)

Part 4: Updates to Other Consensus Policies

Charter Question

n) URS

n1) Should Temporary Specification language be confirmed, or are additional adjustments needed?

o) UDRP

o1) Should Temporary Specification language be confirmed, or are additional adjustments needed?

EPDP Team considerations and deliberations in addressing the charter questions

- The EPDP Team noted that as of the Team’s deliberations, although some members have reported no significant issues in relation to the functioning and operation of the URS and UDRP following the adoption of the Temporary Specification, others reported difficulties as access to domain name registration pre-filing is often unavailable in the absence of an agreed upon standard for “reasonable access”.
- The EPDP Team also took note of the fact that an existing GNSO PDP WG, namely the Review of All Rights Protection Mechanisms in All gTLDs (RPMs) PDP WG, is currently tasked with reviewing the URS and UDRP and is expected to factor in any changes resulting from GDPR requirements.
- The EPDP Team requests that when the EPDP Team commences its deliberations on a standardized access framework, a representative of the RPMs PDP WG shall provide an update on the current status of deliberations so that the EPDP Team may determine if/how the WG’s recommendations may affect consideration of the URS and UDRP in the context of the standardized access framework deliberations.

EPDP Team Recommendation #21.

The EPDP Team recommends that, for the new policy on gTLD registration data, the following requirements MUST apply in relation to URS and UDRP until such time as these are superseded by recommendations from the RPMs PDP WG and/or policies from the EPDP regarding disclosure:

Uniform Rapid Suspension (supplemental requirements for the 17 October 2013 URS High Level Technical Requirements for Registries and Registrars and URS Rules effective 28 June 2013)

(1) Registry Operator Requirement: The Registry Operator (or appointed BERO) MUST provide the URS provider with the full Registration Data for each of the specified domain names, upon the URS provider notifying the Registry Operator (or appointed BERO) of the existence of a complaint, or participate in another mechanism to provide the full Registration Data to the Provider as specified by ICANN. If the gTLD operates as a "thin" registry, the Registry Operator MUST provide the available Registration Data to the URS Provider.

(2) Registrar Requirement: If the domain name(s) subject to the complaint reside on a "thin" registry, the Registrar MUST provide the full Registration Data to the URS Provider upon notification of a complaint.

(3) URS Rules: Complainant's complaint will not be deemed defective for failure to provide the name of the Respondent (Registered Name Holder) and all other relevant contact information required by Section 3 of the URS Rules if such contact information of the Respondent is not available in registration data publicly available in RDDS or not otherwise known to Complainant. In such an event, Complainant may file a complaint against an unidentified Respondent and the Provider shall provide the Complainant with the relevant contact details of the Registered Name Holder after being presented with a complaint against an unidentified Respondent.

Uniform Dispute Resolution Policy (supplemental requirements for the Rules for Uniform Domain Name Dispute Resolution Policy (the "Rules"))

(1) Registrar Requirement: The Registrar MUST provide the UDRP provider with the full Registration Data for each of the specified domain names, upon the UDRP provider notifying the Registrar of the existence of a complaint, or participate in another mechanism to provide the full Registration Data to the Provider as specified by ICANN.

(2) Complainant's complaint will not be deemed defective for failure to provide the name of the Respondent (Registered Name Holder) and all other relevant contact information required by Section 3 of the UDRP Rules if such contact information of the Respondent is not available in registration data publicly available in RDDS or not otherwise known to Complainant. In such an event, Complainant may file a complaint against an unidentified Respondent and the Provider shall provide the Complainant with the relevant contact details of the Registered Name Holder after being presented with a complaint against an unidentified Respondent.

EPDP Team Recommendation #22.

The EPDP Team also recommends that the GNSO Council instructs the review of all RPMs PDP WG to consider, as part of its deliberations, whether there is a need to update existing requirements to clarify that a complainant must only be required to insert the publicly-available RDDS data for the domain name(s) at issue in its initial complaint. The EPDP Team also recommends the GNSO Council to instruct the RPMs PDP WG to consider whether upon receiving updated RDDS data (if any), the complainant must be given the opportunity to file an amended complaint containing the updated respondent information.

EPDP Team Recommendation #23.

The EPDP Team recommends that ICANN Org must enter into appropriate data protection agreements with dispute resolution providers in which, amongst other items, the data retention period is specifically addressed.

Charter Question

p) Transfer Policy

- p1) Should Temporary Specification language be confirmed or modified until a dedicated PDP can revisit the current transfer policy?
- p2) If so, which language should be confirmed, the one based on RDAP or the one based in current WHOIS?

EPDP Team considerations and deliberations in addressing the charter questions

- The EPDP Team noted that as of the Team's deliberations, no significant issues have been reported in relation to the functioning and operation of the Transfer Policy, although some indicated that based on anecdotal evidence, the number of hijacking incidents may have gone down as the result of the registrant email address no longer being published, while others pointed to increased security risks as a result of those changes.
- The EPDP Team also took note of the fact that a review of the Transfer Policy has commenced which, in addition to including an overall review of the Transfer Policy, also includes additional information as to how the GDPR and the Temporary Specification requirements have affected inter-registrar transfers.

EPDP Team Recommendation #24.

The EPDP Team recommends that for the new policy on gTLD registration data, the following requirements MUST apply in relation to the Transfer Policy until such time these are superseded by recommendations that may come out of the Transfer Policy review that is being undertaken by the GNSO Council:

Supplemental procedures for the [Transfer Policy](#) applicable to all ICANN-accredited Registrars

(a) Until such time when the RDAP service (or other secure methods for transferring data) is required by ICANN to be offered, if the Gaining Registrar is unable to gain access to then-

current Registration Data for a domain name subject of a transfer, the related requirements in the Transfer Policy will be superseded by the below provisions:

(a1) The Gaining Registrar is not REQUIRED to obtain a Form of Authorization from the Transfer Contact.

(a2) The Registrant MUST independently re-enter Registration Data with the Gaining Registrar. In such instance, the Gaining Registrar is not REQUIRED to follow the Change of Registrant Process as provided in Section II.C. of the Transfer Policy.

(b) As used in the Transfer Policy:

(b1) The term "Whois data" SHALL have the same meaning as "Registration Data".

(b2) The term "Whois details" SHALL have the same meaning as "Registration Data".

(b3) The term "Publicly accessible Whois" SHALL have the same meaning as "RDDS".

(b4) The term "Whois" SHALL have the same meaning as "RDDS".

(c) Registrar and Registry Operator SHALL follow best practices in generating and updating the "AuthInfo" code to facilitate a secure transfer process.

(d) Registry Operator MUST verify that the "AuthInfo" code provided by the Gaining Registrar is valid in order to accept an inter-registrar transfer request.

EPDP Team Recommendation #25.

The EPDP Team recommends that the GNSO Council, as part of its review of the Transfer Policy, specifically requests the review of the implications, as well as adjustments, that may be needed to the Transfer Policy as a result of GDPR, with great urgency.

Charter Question

q) Sunsetting WHOIS Contractual Requirements

q1) After migration to RDAP, when can requirements in the Contracts to use WHOIS protocol be eliminated?

q2) If EPDP Team's decision includes a replacement directory access protocol, such as RDAP, when can requirements in the Contracts to use WHOIS protocol be eliminated?

At the time of publication of this Final Report, the EPDP Team elected to prioritize its policy recommendations with respect to the Temporary Specification. The EPDP Team believes addressing eventual migration to RDAP and sunsetting of WHOIS requirements is premature at this time, i.e., before the policy recommendations are implemented and work on RDAP has been finalized.

While the exact date of the possible elimination of WHOIS requirements will be determined in the policy implementation phase, the EPDP Team notes any current WHOIS requirements negated or made redundant by eventual policy recommendations will no longer be required.

Other recommendations

EPDP Team Recommendation #26.
 The EPDP Team recommends that ICANN Org enters into required data processing agreements such as a Data Processing Agreement (GDPR Art. 28) or Joint Controller Agreement (Art. 26), as appropriate, with the non-Contracted Party entities involved in registration data processing such as data escrow providers and EBERO providers. These agreements are expected to set out the relationship obligations and instructions for data processing between the different parties.

EPDP Team Recommendation #27.
 The EPDP Team recommends that as part of the implementation of these policy recommendations, updates are made to the following existing policies / procedures, and any others that may have been omitted, to ensure consistency with these policy recommendations as, for example, a number of these refer to administrative and/or technical contact which will no longer be required data elements:

- [Registry Registration Data Directory Services Consistent Labeling and Display Policy](#)
- [Thick WHOIS Transition Policy for .COM, .NET, .JOBS](#)
- [Rules for Uniform Domain Name Dispute Resolution Policy](#)
- [WHOIS Data Reminder Policy](#)
- [Transfer Policy](#)
- [Uniform Rapid Suspension System \(URS\) Rules](#)
- [Transfer Dispute Resolution Policy](#)

Implementation

Although the objective is to keep the timeframe for implementation to a minimum, additional time will be necessary to implement these policy recommendations. As such, the EPDP Team has considered how to avoid a gap between the adoption of these policy recommendations by the ICANN Board and the subsequent implementation, noting the impending expiration of the Temporary Specification requirements. As such:

EPDP Team Recommendation #28.
 The EPDP Team recommends that the effective date of the gTLD Registration Data Policy shall be February 29, 2020. All gTLD Registry Operators and ICANN-accredited registrars will be required to comply with the gTLD Registration Data Policy as of that date. The EPDP Team recommends that until February 29, 2020, registries and registrars are required EITHER to comply with this gTLD Registration Data Policy OR continue to implement measures consistent with the Temporary Specification (as adopted by the ICANN Board on 17 May 2018, and expired on 25 May 2019). Registries and registrars who continue to implement

- Deleted: [[[
- Deleted: [
- Deleted:]
- Deleted: [
- Deleted:]

Deleted: 9 February 2019

measures compliant with the expired Temporary Specification will not be subject to Compliance penalty specifically related to those measures until February 29, 2020.

The EPDP Team furthermore recommends that, as a matter of urgency, the GNSO Council and ICANN Org, informally convene the Implementation Review Team to allow for the necessary planning to take place before ICANN Board consideration of this Final Report, following which the IRT would be formally convened.

Deleted:]]]

Deleted: ¶
In addition, ¶

EPDP Team Recommendation #29.

Recognizing that in the case of some existing registrations, there may be an Administrative Contact but no or incomplete Registered Name Holder contact information, the EPDP team recommends that prior to eliminating Administrative Contact fields, all Registrars must ensure that each registration contains Registered Name Holder contact information.

Furthermore, the EPDP Team expects that as part of the implementation process due consideration is given to how appropriate notice is provided to the Registered Name Holder of the changes that will occur as a result of these policy recommendations to allow the Registered Name Holder to adjust as necessary. If deemed appropriate, this could follow an approach similar to the one described for the Organization Field transition process.

Implementation Guidance

In relation to the definitional work that will take place during the implementation phase, “Registration Data” will mean the data elements identified in Annex D, collected from a natural and legal person in connection with a domain name registration.

The EPDP Team expects that the same due diligence is undertaken in the implementation phase in relation to understanding and assuring compliance with GDPR and due consideration is given to the definition of personal data (see e.g. <https://ico.org.uk/for-organisations/guide-to-data-protection/guide-to-the-general-data-protection-regulation-gdpr/key-definitions/what-is-personal-data/>).

EPDP Team’s Policy Change Impact Analysis

Per the EPDP Team’s Charter, the goal of this effort is to determine if the Temporary Specification for gTLD Registration Data should become an ICANN Consensus Policy, as is or with modifications, while complying with the GDPR and other relevant privacy and data protection law. As part of this determination, the EPDP Team has considered the elements of the Temporary Specification as outlined in the charter and answered the charter questions. The EPDP Team has considered what subsidiary recommendations it might make for future work by the GNSO which might be necessary to ensure relevant Consensus Policies, including those related to registration data, are reassessed to become consistent with applicable law (see relevant recommendations).

The EPDP Team recommends that as part of the implementation process further consideration will be given to a set of metrics to help inform the evaluation to measure success of these policy recommendations.

6 Next Steps

6.1 Next Steps

This Final Report will be submitted to the GNSO Council for its consideration and approval.

Glossary

1. Advisory Committee

An Advisory Committee is a formal advisory body made up of representatives from the Internet community to advise ICANN on a particular issue or policy area. Several are mandated by the ICANN Bylaws and others may be created as needed. Advisory committees have no legal authority to act for ICANN, but report their findings and make recommendations to the ICANN Board.

2. ALAC - At-Large Advisory Committee

ICANN's At-Large Advisory Committee (ALAC) is responsible for considering and providing advice on the activities of the ICANN, as they relate to the interests of individual Internet users (the "At-Large" community). ICANN, as a private sector, non-profit corporation with technical management responsibilities for the Internet's domain name and address system, will rely on the ALAC and its supporting infrastructure to involve and represent in ICANN a broad set of individual user interests.

3. Business Constituency

The Business Constituency represents commercial users of the Internet. The Business Constituency is one of the Constituencies within the Commercial Stakeholder Group (CSG) referred to in Article 11.5 of the ICANN bylaws. The BC is one of the stakeholder groups and constituencies of the Generic Names Supporting Organization (GNSO) charged with the responsibility of advising the ICANN Board on policy issues relating to the management of the domain name system.

4. ccNSO - The Country-Code Names Supporting Organization

The ccNSO the Supporting Organization responsible for developing and recommending to ICANN's Board global policies relating to country code top-level domains. It provides a forum for country code top-level domain managers to meet and discuss issues of concern from a global perspective. The ccNSO selects one person to serve on the board.

5. ccTLD - Country Code Top Level Domain

ccTLDs are two-letter domains, such as .UK (United Kingdom), .DE (Germany) and .JP (Japan) (for example), are called country code top level domains (ccTLDs) and correspond to a country, territory, or other geographic location. The rules and policies for registering domain names in the ccTLDs vary significantly and ccTLD registries limit use of the ccTLD to citizens of the corresponding country.

For more information regarding ccTLDs, including a complete database of designated ccTLDs and managers, please refer to <http://www.iana.org/cctld/cctld.htm>.

6. Contracted Parties House

The Contracted Parties House (CPH) is one of two houses in the GNSO. The CPH includes the two stakeholder groups, the Registry Stakeholder Group and the Registrar Stakeholder Group.

7. Domain Name Registration Data

Domain name registration data, also referred to registration data, refers to the information that registrants provide when registering a domain name and that registrars or registries collect. Some of this information is made available to the public. For interactions between ICANN Accredited Generic Top-Level Domain (gTLD) registrars and registrants, the data elements are specified in the current RAA. For country code Top Level Domains (ccTLDs), the operators of these TLDs set their own or follow their government's policy regarding the request and display of registration information.

8. Domain Name

As part of the Domain Name System, domain names identify Internet Protocol resources, such as an Internet website.

9. DNS - Domain Name System

DNS refers to the Internet domain-name system. The Domain Name System (DNS) helps users to find their way around the Internet. Every computer on the Internet has a unique address - just like a telephone number - which is a rather complicated string of numbers. It is called its "IP address" (IP stands for "Internet Protocol"). IP Addresses are hard to remember. The DNS makes using the Internet easier by allowing a familiar string of letters (the "domain name") to be used instead of the arcane IP address. So instead of typing 207.151.159.3, you can type www.internic.net. It is a "mnemonic" device that makes addresses easier to remember.

10. EPDP – Expedited Policy Development Process

A set of formal steps, as defined in the ICANN bylaws, to guide the initiation, internal and external review, timing and approval of policies needed to coordinate the global Internet's system of unique identifiers. An EPDP may be initiated by the GNSO Council only in the following specific circumstances: (1) to address a narrowly defined policy issue that was identified and scoped after either the adoption of a GNSO policy recommendation by the ICANN Board or the implementation of such an adopted recommendation; or (2) to provide new or additional policy recommendations on a specific policy issue that had been substantially scoped previously, such that extensive, pertinent background information already exists, e.g. (a) in an Issue Report for a possible PDP that was not initiated; (b) as part of a previous PDP that was not completed; or (c) through other projects such as a GNSO Guidance Process.

11. GAC - Governmental Advisory Committee

The GAC is an advisory committee comprising appointed representatives of national governments, multi-national governmental organizations and treaty organizations, and

distinct economies. Its function is to advise the ICANN Board on matters of concern to governments. The GAC will operate as a forum for the discussion of government interests and concerns, including consumer interests. As an advisory committee, the GAC has no legal authority to act for ICANN, but will report its findings and recommendations to the ICANN Board.

12. General Data Protection Regulation (GDPR)

The General Data Protection Regulation (EU) 2016/679 (GDPR) is a regulation in EU law on data protection and privacy for all individuals within the European Union (EU) and the European Economic Area (EEA). It also addresses the export of personal data outside the EU and EEA areas.

13. GNSO - Generic Names Supporting Organization

The supporting organization responsible for developing and recommending to the ICANN Board substantive policies relating to generic top-level domains. Its members include representatives from gTLD registries, gTLD registrars, intellectual property interests, Internet service providers, businesses and non-commercial interests.

14. Generic Top Level Domain (gTLD)

"gTLD" or "gTLDs" refers to the top-level domain(s) of the DNS delegated by ICANN pursuant to a registry agreement that is in full force and effect, other than any country code TLD (ccTLD) or internationalized domain name (IDN) country code TLD.

15. gTLD Registries Stakeholder Group (RySG)

The gTLD Registries Stakeholder Group (RySG) is a recognized entity within the Generic Names Supporting Organization (GNSO) formed according to Article X, Section 5 (September 2009) of the Internet Corporation for Assigned Names and Numbers (ICANN) Bylaws.

The primary role of the RySG is to represent the interests of gTLD registry operators (or sponsors in the case of sponsored gTLDs) ("Registries") (i) that are currently under contract with ICANN to provide gTLD registry services in support of one or more gTLDs; (ii) who agree to be bound by consensus policies in that contract; and (iii) who voluntarily choose to be members of the RySG. The RySG may include Interest Groups as defined by Article IV. The RySG represents the views of the RySG to the GNSO Council and the ICANN Board of Directors with particular emphasis on ICANN consensus policies that relate to interoperability, technical reliability and stable operation of the Internet or domain name system.

16. ICANN - The Internet Corporation for Assigned Names and Numbers

The Internet Corporation for Assigned Names and Numbers (ICANN) is an internationally organized, non-profit corporation that has responsibility for Internet Protocol (IP) address space allocation, protocol identifier assignment, generic (gTLD) and country code (ccTLD) Top-Level Domain name system management, and root server system management functions. Originally, the Internet Assigned Numbers Authority (IANA) and other entities

performed these services under U.S. Government contract. ICANN now performs the IANA function. As a private-public partnership, ICANN is dedicated to preserving the operational stability of the Internet; to promoting competition; to achieving broad representation of global Internet communities; and to developing policy appropriate to its mission through bottom-up, consensus-based processes.

17. Intellectual Property Constituency (IPC)

The Intellectual Property Constituency (IPC) represents the views and interests of the intellectual property community worldwide at ICANN, with a particular emphasis on trademark, copyright, and related intellectual property rights and their effect and interaction with Domain Name Systems (DNS). The IPC is one of the constituency groups of the Generic Names Supporting Organization (GNSO) charged with the responsibility of advising the ICANN Board on policy issues relating to the management of the domain name system.

18. Internet Service Provider and Connectivity Provider Constituency (ISPCP)

The ISPs and Connectivity Providers Constituency is a constituency within the GNSO. The Constituency's goal is to fulfill roles and responsibilities that are created by relevant ICANN and GNSO bylaws, rules or policies as ICANN proceeds to conclude its organization activities. The ISPCP ensures that the views of Internet Service Providers and Connectivity Providers contribute toward fulfilling the aims and goals of ICANN.

19. Name Server

A Name Server is a DNS component that stores information about one zone (or more) of the DNS name space.

20. Non Commercial Stakeholder Group (NCSG)

The Non Commercial Stakeholder Group (NCSG) is a Stakeholder Group within the GNSO. The purpose of the Non Commercial Stakeholder Group (NCSG) is to represent, through its elected representatives and its Constituencies, the interests and concerns of noncommercial registrants and noncommercial Internet users of generic Top-level Domains (gTLDs). It provides a voice and representation in ICANN processes to: non-profit organizations that serve noncommercial interests; nonprofit services such as education, philanthropies, consumer protection, community organizing, promotion of the arts, public interest policy advocacy, children's welfare, religion, scientific research, and human rights; public interest software concerns; families or individuals who register domain names for noncommercial personal use; and Internet users who are primarily concerned with the noncommercial, public interest aspects of domain name policy.

21. Non-Contracted Parties House

The Non-Contracted Parties House (NCPH) is one of the two major structures making up the GNSO. The GNSO is a bicameral structure, with one house made up of those that are directly contracting with ICANN, and the other for those that are not. The NCPH includes members who are internet service providers, businesses, connectivity providers and intellectual

property constituencies. The NCPH is composed of the Commercial and Non-Commercial Stakeholders Groups.

22. Post Delegation Dispute Resolution Procedures (PDDRs)

Post-Delegation Dispute Resolution Procedures have been developed to provide those harmed by a new gTLD Registry Operator's conduct an alternative avenue to complain about that conduct. All such dispute resolution procedures are handled by providers external to ICANN and require that complainants take specific steps to address their issues before filing a formal complaint. An Expert Panel will determine whether a Registry Operator is at fault and recommend remedies to ICANN.

23. Registered Name

"Registered Name" refers to a domain name within the domain of a gTLD, whether consisting of two (2) or more (e.g., john.smith.name) levels, about which a gTLD Registry Operator (or an Affiliate or subcontractor thereof engaged in providing Registry Services) maintains data in a Registry Database, arranges for such maintenance, or derives revenue from such maintenance. A name in a Registry Database may be a Registered Name even though it does not appear in a zone file (e.g., a registered but inactive name).

24. Registrar

The word "registrar," when appearing without an initial capital letter, refers to a person or entity that contracts with Registered Name Holders and with a Registry Operator and collects registration data about the Registered Name Holders and submits registration information for entry in the Registry Database.

25. Registrar Accreditation Agreement

The Registrar Accreditation Agreement (RAA) is the contract that governs the relationship between ICANN and its accredited registrars. The RAA sets out the obligations of both parties.

26. Registrars Stakeholder Group (RrSG)

The Registrars Stakeholder Group is one of several Stakeholder Groups within the ICANN community and is the representative body of registrars. It is a diverse and active group that works to ensure the interests of registrars and their customers are effectively advanced. We invite you to learn more about accredited domain name registrars and the important roles they fill in the domain name system.

27. Registry Agreement

The Registry Agreement (RA) is the contract that governs the relationship between ICANN and each Registry Operator. The RA sets out the obligations of both parties.

28. Registry Operator

A "Registry Operator" is the person or entity then responsible, in accordance with an agreement between ICANN (or its assignee) and that person or entity (those persons or entities) or, if that agreement is terminated or expires, in accordance with an agreement between the US Government and that person or entity (those persons or entities), for providing Registry Services for a specific gTLD.

29. Registry-Registrar Agreement

The Registry-Registrar Agreement is a contract between a Registrar and a Registry operator that sets out the obligations both parties.

30. Registration Data Directory Service (RDDS)

Domain Name Registration Data Directory Service or RDDS refers to the service(s) offered by registries and registrars to provide access to Domain Name Registration Data.

31. Registration Restrictions Dispute Resolution Procedure (RRDRP)

The Registration Restrictions Dispute Resolution Procedure (RRDRP) is intended to address circumstances in which a community-based New gTLD Registry Operator deviates from the registration restrictions outlined in its Registry Agreement.

32. SO - Supporting Organizations

The SOs are the three specialized advisory bodies that advise the ICANN Board of Directors on issues relating to domain names (GNSO and CCNSO) and, IP addresses (ASO).

33. SSAC - Security and Stability Advisory Committee

An advisory committee to the ICANN Board comprised of technical experts from industry and academia as well as operators of Internet root servers, registrars and TLD registries.

34. TLD - Top-level Domain

TLDs are the names at the top of the DNS naming hierarchy. They appear in domain names as the string of letters following the last (rightmost) ".", such as "net" in <http://www.example.net>. The administrator for a TLD controls what second-level names are recognized in that TLD. The administrators of the "root domain" or "root zone" control what TLDs are recognized by the DNS. Commonly used TLDs include .COM, .NET, .EDU, .JP, .DE, etc.

35. Uniform Dispute Resolution Policy (UDRP)

The Uniform Dispute Resolution Policy (UDRP) is a rights protection mechanism that specifies the procedures and rules that are applied by registrars in connection with disputes that arise over the registration and use of gTLD domain names. The UDRP provides a mandatory administrative procedure primarily to resolve claims of abusive, bad faith domain name registration. It applies only to disputes between registrants and third parties, not disputes between a registrar and its customer.

36. Uniform Rapid Suspension (URS)

The Uniform Rapid Suspension System is a rights protection mechanism that complements the existing Uniform Domain-Name Dispute Resolution Policy (UDRP) by offering a lower-cost, faster path to relief for rights holders experiencing the most clear-cut cases of infringement.

37. WHOIS

WHOIS protocol is an Internet protocol that is used to query databases to obtain information about the registration of a domain name (or IP address). The WHOIS protocol was originally specified in RFC 954, published in 1985. The current specification is documented in RFC 3912. ICANN's gTLD agreements require registries and registrars to offer an interactive web page and a port 43 WHOIS service providing free public access to data on registered names. Such data is commonly referred to as "WHOIS data," and includes elements such as the domain registration creation and expiration dates, nameservers, and contact information for the registrant and designated administrative and technical contacts.

WHOIS services are typically used to identify domain holders for business purposes and to identify parties who are able to correct technical problems associated with the registered domain.

Annex A - Background

Process Background

On 19 July 2018, the GNSO Council [initiated](#) an Expedited Policy Development Process (EPDP) and [chartered](#) the EPDP on the Temporary Specification for gTLD Registration Data Team. Unlike other GNSO PDP efforts, which are open for anyone to join, the GNSO Council chose to limit the membership composition of this EPDP, primarily in recognition of the need to complete the work in a relatively short timeframe and to resource the effort responsibly. GNSO Stakeholder Groups, the Governmental Advisory Committee (GAC), the Country Code Supporting Organization (ccNSO), the At-Large Advisory Committee (ALAC), the Root Server System Advisory Committee (RSSAC) and the Security and Stability Advisory Committee (SSAC) were each been invited to appoint up to a set number of members and alternates, as outlined in the [charter](#). In addition, the ICANN Board and ICANN Org have been invited to assign a limited number of liaisons to this effort. A call for volunteers to the aforementioned groups was issued in July, and the EPDP Team held its first meeting on [1 August 2018](#).

Issue Background

On 17 May 2018, the ICANN Board of Directors (ICANN Board) adopted the [Temporary Specification for generic top-level domain \(gTLD\) Registration Data](#) (“Temporary Specification”) pursuant to the procedures for the establishment of temporary policies in ICANN’s agreements with Registry Operators and Registrars (“Contracts”). The Temporary Specification provides modifications to existing requirements in the Registrar Accreditation and Registry Agreements in order to comply with the European Union’s General Data Protection Regulation (“GDPR”). Following adoption of a temporary specification, the procedure for Temporary Policies as outlined in the Registrar Accreditation and Registry Agreements, provides the Board “shall immediately implement the Consensus Policy development process set forth in ICANN’s Bylaws”. Additionally, the procedure provides this Consensus Policy development process on the Temporary Specification must be carried out within a one-year period as the Temporary Specification can only remain in force for up to one year, from the effective date of 25 May 2018, i.e., the Temporary Specification will expire on 25 May 2019.

On 19 July 2018, the GNSO Council [initiated](#) an Expedited Policy Development Process (EPDP) and [chartered](#) the EPDP on the Temporary Specification for gTLD Registration Data Team. The EPDP Team held its first meeting on [1 August 2018](#).

Deleted: 9 February 2019

Annex B – EPDP Team Membership and Attendance

EPDP Team Membership and Attendance

The members of the EPDP Team are:

	Members / Liaisons	Affiliation	SOI	% of Meetings Attended ⁶²
1	Alan Woods	RySG	SOI	91.2
2	Kristina Rosette ⁶³	RySG	SOI	91.1
2	Beth Bacon ⁶⁴	RySG	SOI	14.0
3	Marc Anderson	RySG	SOI	100
4	James M. Bladel	RrSG	SOI	77.2
5	Matt Serlin	RrSG	SOI	86.0
6	Emily Taylor	RrSG	SOI	84.2
7	Alex Deacon	IPC	SOI	91.2
8	Diane Plaut	IPC	SOI	89.5
9	Margie Milam	BC	SOI	93.0
10	Mark Svancarek	BC	SOI	93.0
11	Esteban Lescano ⁶⁵	ISPCP	SOI	32.7
11	Fiona Assonga ⁶⁶	ISPCP	SOI	10.5
12	Thomas Rickert	ISPCP	SOI	91.2
13	Stephanie Perrin	NCSG	SOI	96.5

Deleted: 1

Deleted: 12.5

Deleted: 78

Deleted: 6

Deleted: 85

Deleted: 7

Deleted: 81

Deleted: 6

Deleted: 1

Deleted: 3

Deleted: 92

Deleted: 9

Deleted: 92

Deleted: 9

Deleted: 35

Deleted: 3

Deleted: 7

Deleted: 1

Deleted: 4

⁶² This does not include attendance to F2F meetings which is recorded separately. See <https://community.icann.org/x/rQarBQ>, <https://community.icann.org/x/0QO8BQ>, <https://community.icann.org/x/1AO8BQ>, <https://community.icann.org/x/2gO8BQ>, <https://community.icann.org/x/3wO8BQ> and https://community.icann.org/x/sAn_BQ.

⁶³ changed to observer on 08, February 2019

⁶⁴ changed to member on 08, February for Kristina Rosette until 31, March 2019

⁶⁵ Resigned 6 February 2019

⁶⁶ Became member on 06, February 2019 - no longer alternate due to Esteban Lescano' leaving

Deleted: 9 February 2019

	Members / Liaisons	Affiliation	SOI	% of Meetings Attended ⁶²
14	Ayden Férdeline	NCSG	SOI	<u>71.9</u>
15	Milton Mueller	NCSG	SOI	73.7
16	Julf Helsingius	NCSG	SOI	89.5
17	Amr Elsadr	NCSG	SOI	<u>84.2</u>
18	Farzaneh Badiel	NCSG	SOI	87.7
19	Georgios Tselentis	GAC	SOI	73.7
20	Kavouss Arasteh	GAC	SOI	<u>86.5</u>
21	Ashley Heineman	GAC	SOI	<u>68.4</u>
22	Alan Greenberg	ALAC	SOI	91.2
23	Hadia Elminiawi	ALAC	SOI	100
24	Benedict Addis	SSAC	SOI	<u>78.9</u>
25	Ben Butler	SSAC	SOI	94.7
26	Chris Disspain	ICANN Board Liaison	SOI	<u>92.1</u>
27	Leon Felipe Sanchez	ICANN Board Liaison	SOI	75.4
28	Rafik Dammak	GNSO Council Liaison	SOI	100
29	Trang Nguyen	ICANN Org Liaison (GDD)	SOI	Not tracked
30	Dan Halloran	ICANN Org Liaison (Legal)	n/a	Not tracked
31	Kurt Pritz	EPDP Team Chair	SOI	100

Deleted: 73

Deleted: 2

Deleted: 2

Deleted: 3

Deleted: 85

Deleted: 7

Deleted: 5

Deleted: 2

Deleted: 84

Deleted: 6

Deleted: 69

Deleted: 9

Deleted: 1

Deleted: 80

Deleted: 4

Deleted: 6

Deleted: 89.5

The alternates of the EPDP Team are:

Deleted: 9 February 2019

	Alternates	Affiliation	SOI	% of Meetings Attended
1	TBC	RySG		
2	Arnaud Wittersheim	RySG	SOI	1.8
3	Sebastien Ducos	RySG	SOI	1.8
4	Jeff Yeh ⁶⁷	RrSG	SOI	3.8
4	Volker Greimann ⁶⁸	RrSG	SOI	6.5
5	Lindsay Hamilton-Reid ⁶⁹	RrSG	SOI	42.1
5	Sarah Wyld ⁷⁰	RrSG	SOI	61.5
6	Theo Geurts	RrSG	SOI	22.8
7	Brian King	IPC	SOI	17.5
8	Steve DelBianco	BC	SOI	7.0
9	Suman Lal Pradhan ⁷¹	ISPCP	SOI	0
10	Tatiana Tropina	NCSG	SOI	21.1
11	David Cake	NCSG	SOI	5.3
12	Collin Kurre	NCSG	SOI	28.1
13	Chris Lewis-Evans	GAC	SOI	36.8
14	Rahul Gosain	GAC	SOI	14.0
15	Laureen Kapin	GAC	SOI	19.3
16	Holly Raiche	ALAC	SOI	1.8

Deleted: 4

Deleted: 5

Deleted: 5.9

Deleted: 38.9

Deleted: 23

Deleted: 2

Deleted: 9

Deleted: 1

Deleted: 4

Deleted: 4

Deleted: 26

Deleted: 8

Deleted: 37

Deleted: 57

Deleted: 3

Deleted: 17

Deleted: 9

⁶⁷ changed to observer 08, October 2018

⁶⁸ Joined as alternate on 08, October 2018

⁶⁹ Resigned as alternate on 18, December 2018

⁷⁰ Joined as alternate on 18, December 2018

⁷¹ Joined as alternate on 06, February 2019 replacing Fiona Assonga as the alternate

Deleted: 9 February 2019

17	Seun Ojedeji	ALAC	SOI	3.5
18	Greg Aaron	SSAC	SOI	8.8
19	Rod Rasmussen	SSAC	SOI	8.8

Deleted: 6

Deleted: 7.1

Deleted: 9

EPDP Staff Support Team
Berry Cobb
Caitlin Tubergen
Marika Konings
Andrea Glandon
Terri Agnew

The detailed attendance records can be found at <https://community.icann.org/x/4opHBQ>.

The EPDP Team email archives can be found at <https://mm.icann.org/pipermail/gnso-epdp-team/>.

* The following are the ICANN SO/ACs and GNSO Stakeholder Groups and Constituencies for which EPDP TEAM members provided affiliations:

- RrSG – Registrar Stakeholder Group
- RySG – Registry Stakeholder Group
- BC – Business Constituency
- NCSG – Non-Commercial Stakeholder Group
- IPC – Intellectual Property Constituency
- ISPCP – Internet Service and Connection Providers Constituency
- GAC – Governmental Advisory Committee
- ALAC – At-Large Advisory Committee
- SSAC – Security and Stability Advisory Committee

Annex C - Community Input

Request for Input

According to the GNSO's PDP Manual, an EPDP Team should formally solicit statements from each GNSO Stakeholder Group and Constituency at an early stage of its deliberations. An EPDP Team is also encouraged to seek the opinion of other ICANN Supporting Organizations and Advisory Committees who may have expertise, experience or an interest in the issue. As a result, the EPDP Team reached out to all ICANN Supporting Organizations and Advisory Committees as well as GNSO Stakeholder Groups and Constituencies with a request for input at the start of its deliberations. In response, statements were received from:

- The GNSO Business Constituency (BC)
- The GNSO Intellectual Property Constituency (IPC)
- The GNSO Non-Commercial Stakeholder Group (NCSG)
- The Registries Stakeholder Group (RySG)
- The At-Large Advisory Committee (ALAC)
- The Governmental Advisory Committee (GAC)
- The Security and Stability Advisory Committee (SSAC)

The full statements can be found here: <https://community.icann.org/x/Ag9pBQ>.

Review of Input Received

All of the statements received were added to the [Discussion Summary Index](#) for the corresponding section in the Temporary Specification (where applicable) and reviewed by the EPDP Team as part of its deliberations on that particular topic.

Annex D – Data Elements Workbooks

Table of Contents:

#	Purpose	Link
1A	In accordance with the relevant registry agreements and registrar accreditation agreements, activate a registered name and allocate it to the Registered Name Holder.	LINK
1B	Subject to the Registry and Registrar Terms, Conditions and Policies and ICANN Consensus Policies: <ol style="list-style-type: none"> i. Establish the rights of a Registered Name Holder in a Registered Name; and ii. Ensure that a Registered Name Holder may exercise its right in the use, maintenance and disposition of the Registered Name. 	LINK
2	Contributing to the maintenance of the security, stability, and resiliency of the Domain Name System in accordance with ICANN's mission through enabling responses to lawful data disclosure requests.	LINK
3	Enable communication with the Registered Name Holder on matters relating to the Registered Name.	LINK
4A	Provide mechanisms for safeguarding Registered Name Holders' Registration Data in the event of a business or technical failure of a Registrar or Registry Operator, or unavailability of a Registrar or Registry Operator, as described in the RAA and RA, respectively.	LINK
4B	Provide mechanisms for safeguarding Registered Name Holders' Registration Data in the event of a business or technical failure of a Registrar or Registry Operator, or unavailability of a Registrar or Registry Operator, as described in the RAA and RA, respectively.	LINK
5	<ol style="list-style-type: none"> i. Handle contractual compliance monitoring requests and audit activities consistent with the terms of the Registry agreement and the Registrar accreditation agreements and any applicable data processing agreements, by processing specific data only as necessary; ii. Handle compliance complaints initiated by ICANN, or third parties consistent with the terms of the Registry agreement and the Registrar accreditation agreements. 	LINK
6	Operationalize policies for the resolution of disputes regarding or relating to the registration of domain names (as opposed to the use of such domain names, but including where such policies take into account use of the domain names), namely, the UDRP, URS, PDDRP, RRDRP, and the TDRP	LINK
7	Enabling validation to confirm that Registered Name Holder meets gTLD registration policy eligibility criteria voluntarily adopted by Registry Operator and that are described or referenced in the Registry Agreement for that gTLD.	LINK

In a previous version of this document, the term “ICANN Purpose” was used in the title of the Purpose Statement for each workbook to describe purposes for processing registration data, including personal data, that should be governed by ICANN via a Consensus Policy. “ICANN” has since been removed, but the principle still applies. Note there are additional purposes for processing personal data, which the contracted parties may pursue, such as billing customers, but these are outside of what ICANN and its community should develop policy on or contractually enforce. It does not necessarily mean that such purpose is solely pursued by ICANN Org.

Primary Processing Activity Definitions:*Preamble*

Definitions have been supplied with the primary types of Processing Activities of Collection, Transmission, Disclosure, and Retention. It is hoped that these definitions will provide clarity to documenting the Processing Activities and avoid confusion of their use in policy versus what may actually occur technically.

Collection

The processing action whereby the Controller or Processor gains (or gains access to) the data.

Transmission/Transfer

The processing action whereby data is disclosed by a Controller or Processor to another party when that other party is involved in the processing of those data.

Disclosure⁷²

The processing action whereby the Controller accepts responsibility for release of personal information to third parties upon request.

Publication

The processing action whereby data is disclosed to third parties, by being made publicly available for a public interest purpose.

Retention

When the primary purpose of data processing has been achieved, and/or the data is no longer required for that purpose, such data may be retained by a Controller (or Processor), where the Controller (or Processor) has established additional specific and stated purposes, and where such retention is:

- A. Not incompatible with the primary/original purpose for the processing of the data; or*
- B. Reasonably necessary to demonstrate the fulfilment of the original purpose. (e.g. the retention of data to demonstrate completion, by the Controller/Processor, of a contractual obligation in contemplation of defending against claims of breach of contract etc.); and*
- C. Processing of retained data is limited to only those purpose(s) for which such data are retained.*

Other Definitions:

⁷² Not ALL data are necessarily required to be disclosed. The data elements represented in the workbooks are an aggregate of which data may be disclosed, but specific elements are yet to be determined depending on the situation.

- Optional: - In the Initial Report, those data elements marked as “(optional, (O))”, were used in a generic sense and ultimately caused confusion in how they traversed the processing activities.
 - Refined legend: O-RNH, O-Rr, O-CP
 - Optional for Registrant to fill in, but if supplied it must be processed
 - Optional for Registrar to provide, but if supplied it must be processed
 - Optional for contracted party subject to terms and conditions
- Generated: The data elements tables contain a list of in-scope fields of registration data as derived from existing policy, technical specifications, or contract specifications. Fields marked with an “*” are fields that are either collected from the data subject, or automatically “generated” by the registrar or registry.

Lawful Basis:

The workbooks each contain a section that documents the processing activities as well as a space to document the lawful basis. The EPDP has received legal advice regarding the application of Art. 6(1)(b), necessary for performance of a contract, as a lawful basis. To date, outside legal counsel has noted, “A registrar could rely on Article 6(1)(b) as the lawful basis for processing other than simply registering and activating a domain if it can show that such processing is for one of the fundamental objectives of the contract. It would be difficult to argue that that processing to prevent DNS abuse is “necessary for the performance of a contract to which the data subject is party”. Based on this application, we have tentatively marked the processing activities of registrar collection and transfer under as lawful under 6(1)(b), while we have marked all other processing under the other purposes as 6(1)(f), noting this is a placeholder pending further legal analysis. Any designations suggested in the workbooks below is based on the EPDP Team’s best current thinking but that in the end the determination is a result of law not opinion.

Data Flow Diagrams and Data Elements Tables:

- The diagrams are simple representations arrangements (colored data flow lines) between ICANN, Contracted Parties, Service Providers, and the Data Subject (Registrant). They are not an accurate depiction of the exact agreements that may already exist or future ones. Further, the data flows (black lined data flow) are also not representative of what how the data may actually flow technically. More detailed analysis and documentation will be required to accurately reflect the data flow.
- The data elements tables are also limited in how they properly reflect how data traverses the processing activities identified for each purpose. They act more as a policy tool to manage an inventory of data elements used in existing publicly accessible Whois directory today. Further, the roles played are also more complex than what is represented here. For example, the processing activity of a transfer means that one party performs the “transfer”, while the receiving party is “collecting” the data.

1A

PURPOSE:

In accordance with the relevant Registry Agreements and Registrar Accreditation Agreements, activate a registered name and allocate it to the Registered Name Holder.

Purpose Rationale:

1) If the purpose is based on an ICANN contract, cite the relevant section of the ICANN contracts that corresponds to the above purpose, if any.

- RAA - <https://www.icann.org/resources/pages/approved-with-specs-2013-09-17-en>

Yes, this purpose is lawful based on ICANN’s mission to coordinate the allocation and assignment of names in the root zone of the Domain Name System. Specifically, Section 3.2 of the RAA “Submission of Registered Name Holder Data to Registry” refers to what data elements must be placed in the Registry Database as a part of the domain registration (<https://www.icann.org/resources/pages/approved-with-specs-2013-09-17-en>) & <https://www.icann.org/resources/pages/registries/registries-agreements-en>).

2) Is the purpose in violation with ICANN's bylaws?

No, it is not in violation of ICANN’s Bylaws. Specifically, Article 1, Section 1.1 Mission (a)(i) Coordinates the allocation and assignment of names in the root zone of the Domain Name System (“DNS”) and coordinates the development and implementation of policies concerning the registration of second-level domain names in generic top-level domains (“gTLDs”). In this role, ICANN’s scope is to coordinate the development and implementation of policies <https://www.icann.org/resources/pages/governance/bylaws-en/#article1>.

Further, Articles G-1 and G-2 stipulate, “issues for which uniform or coordinated resolution is reasonably necessary to facilitate interoperability, security and/or stability of the Internet, registrar services, registry services, or the DNS;” and “Examples of the above include, without limitation: principles for allocation of registered names in a TLD (e.g., first-come/first-served, timely renewal, holding period after expiration);”

3) Are there any “picket fence” considerations related to this purpose?

This purpose is related to WHOIS, which is within the Picket Fence. Specifically, Specification 1 of the Registry Agreement (Section 3.1(b) (iv) and (v) of legacy RA) and Specification 4 of the Registrar Accreditation Agreement both refer to categories of issues and principles of allocation of registered names in a TLD.

Lawfulness of Processing Test:

Processing Activity:	Responsible Party: <small>(Charter Questions 3k, 3l, 3m)</small>	Lawful Basis: (Is the processing necessary to achieve the purpose?)
1A-PA1: Collection of registration data to allocate and activate	ICANN Registrars Registries	6(1)(b) for Registrars

<p>the domain name string to Registered Name Holder (Charter Question 2b)</p>	<p>RNH</p>	<p>This is a 6(1)(b) purpose for Registrars because it is necessary to collect registrant data to allocate a string to a registrant. Without collecting minimal registrant data, the contracted party has no way of tracing the string back to registrant and is not able to deliver its side of the contract.</p> <p>6(1)(f) for Registries and ICANN</p> <p>This is a 6(1)(f) purpose for Registries receiving such data from Registrars to allocate the domain name at the Registry level, this collection is based on 6(1)(f) purpose.</p> <p>(NOTE: that registries collection of the data occurs only when the data is disclosed to them by the registrar as per 1A-PA2)</p>
<p>1A-PA2: Transmission of registration data from Registrar to Registry (Charter Questions 2c, 2d, 2e, 2i)</p>	<p>ICANN Registrars Registries</p>	<p>Certain data elements (Domain Name and NameServers) would be required to be transferred from the Registrar to Registry. The lawful basis would be 6(1)(b) (vis á vis the processing of the Registrar), should personal data be involved.</p> <p>(NOTE: the Registry's receipt of this data is the collection, as per 1A-PA1)</p>
<p>1A-PA3: Publication of registration data to the DNS (Charter Questions 2f (gating questions), 2j)</p>	<p>ICANN Registrars Registries</p>	<p>Activation of the domain name registration in the DNS requires the publication of certain data elements, namely Domain Name and NameServers. The lawful basis would be 6(1)(f), should personal data be involved.</p> <p>Due to the minimal discretion in the requirements of 1A this is a direction from ICANN on what and how to achieve the result. Registries and Registrars retain minimal discretion and thus are acting as processors in 1A.</p>
<p>1A-PA4: Retention of registration data by Registrar, Registry (Charter Questions 2g) Note, this PA is not represented on the data elements table, because data processed above represents what data elements will be retained</p>	<p>ICANN Registrars Registries</p>	<p>6(1)(f) for Registrars</p> <p>This is a 6(1)(f) purpose because although there is likely a legitimate interest in providing mechanisms for safeguarding Registered Name Holders' Registration Data in the event of a dispute over ownership or an improper transfer, it is not necessary from a technical perspective to retain the data in order to allocate a string to a registered name holder, and therefore is not necessary to perform the registration contract.</p> <p>The EPDP Team agreed to a period of one year following the life of the registration a registration as the retention period in</p>

order to conform with the Transfer Dispute Resolution Policy requirements. Refer to the details around retention in Recommendation #11

6(1)(f) for Registries

Registries need only retain data for the duration of the life of the domain.

Data Flow Map:

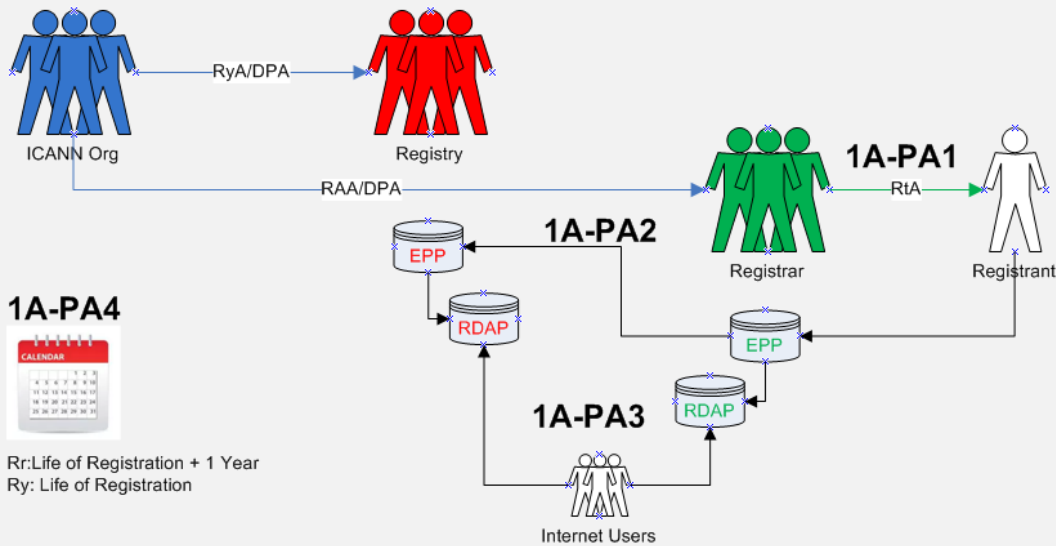

PURPOSE:

In accordance with the relevant Registry Agreements and Registrar Accreditation Agreements, activate a registered name and allocate it to the Registered Name Holder.

Data Elements Matrix:

R = required
 O-RNH, O-Rr, O-CP = optional
 N/A=not applicable

Data Elements (Collected & Generated*)	Collection 1A-PA1	Transmission 1A-PA2	Publication 1A-PA3			
Domain Name	R	R	R			
Registry Domain ID*						
Registrar Whois Server* ⁷³						
Registrar URL*						
Updated Date*						
Creation Date*						
Registry Expiry Date*						
Registrar Registration Expiration Date*						
Registrar*						
Registrar IANA ID*						
Registrar Abuse Contact Email*						
Registrar Abuse Contact Phone*						
Reseller*						
Domain Status(es)* ⁷⁴						
Registry Registrant ID*						
Registrant Fields						
<input type="checkbox"/> Name						
<input type="checkbox"/> Organization (opt.)						
<input type="checkbox"/> Street						
<input type="checkbox"/> City						
<input type="checkbox"/> State/province						
<input type="checkbox"/> Postal code						
<input type="checkbox"/> Country						
<input type="checkbox"/> Phone						
<input type="checkbox"/> Phone ext (opt.)						
<input type="checkbox"/> Fax (opt.)						
<input type="checkbox"/> Fax ext (opt.)						
<input type="checkbox"/> Email						
2nd E-Mail address						
Admin ID*						
Admin Fields						
<input type="checkbox"/> Name						
<input type="checkbox"/> Organization (opt.)						

⁷³ “Registrar Whois Server”, “Registrar URL”, “Registrar Abuse Contact Email” and “Registrar Abuse Contact Phone” are not transmitted to the registry with each registration in EPP; they are provided to the registry once by each registrar and used for each registration a registrar has. I’m not sure if you want to flag this or not.

⁷⁴ “Domain Status” (which is a field that can appear multiple times) may or may not be set by the registrar; some status are set by the registrar, some are set by the registry.

Data Elements (Collected & Generated*)	Collection 1A-PA1	Transmission 1A-PA2	Publication 1A-PA3			
<input type="checkbox"/> Street						
<input type="checkbox"/> City						
<input type="checkbox"/> State/province						
<input type="checkbox"/> Postal code						
<input type="checkbox"/> Country						
<input type="checkbox"/> Phone						
<input type="checkbox"/> Phone ext (opt.)						
<input type="checkbox"/> Fax (opt.)						
<input type="checkbox"/> Fax ext (opt.)						
<input type="checkbox"/> Email						
Tech ID*						
Tech Fields						
<input type="checkbox"/> Name						
<input type="checkbox"/> Organization (opt.)						
<input type="checkbox"/> Street						
<input type="checkbox"/> City						
<input type="checkbox"/> State/province						
<input type="checkbox"/> Postal code						
<input type="checkbox"/> Country						
<input type="checkbox"/> Phone						
<input type="checkbox"/> Phone ext (opt.)						
<input type="checkbox"/> Fax (opt.)						
<input type="checkbox"/> Fax ext (opt.)						
<input type="checkbox"/> Email						
NameServer(s)	O-RNH	O-RNH	O-RNH			
DNSSEC	O-RNH	O-RNH	O-RNH			
Name Server IP Address	O-RNH	O-RNH	O-RNH			
Last Update of Whois Database*						

1B

PURPOSE:

As subject to registry and registrar terms, conditions and policies, and ICANN consensus policies:

- (i) establish the rights of a Registered Name Holder in a registered name, and
- (ii) ensure that a Registered Name Holder may exercise its rights in the use, maintenance and disposition of the Registered Name.

Purpose Rationale:

1) If the purpose is based on an ICANN contract, cite the relevant section of the ICANN contracts that corresponds to the above purpose, if any.

- RAA - <https://www.icann.org/resources/pages/approved-with-specs-2013-09-17-en>

Yes, this purpose is lawful based on ICANN’s mission to coordinate the allocation and assignment of names in the root zone of the Domain Name System. Specifically, Section 3.2 of the RAA “Submission of Registered Name Holder Data to Registry” , Spec. 4, section 1.5 and Spec. 2 of the RA, all refers to what data elements must be placed in the Registry Database as a part of the domain registration (<https://www.icann.org/resources/pages/approved-with-specs-2013-09-17-en> & <https://www.icann.org/resources/pages/registries/registries-agreements-en>).

2) Is the purpose in violation with ICANN's bylaws?

No, it is not in violation of ICANN’s Bylaws. Specifically, Article 1, Section 1.1 Mission (a)(i) Coordinates the allocation and assignment of names in the root zone of the Domain Name System (“DNS”) and coordinates the development and implementation of policies concerning the registration of second-level domain names in generic top-level domains (“gTLDs”). In this role, ICANN's scope is to coordinate the development and implementation of policies <https://www.icann.org/resources/pages/governance/bylaws-en/#article1>.

Further, Articles G-1 and G-2 stipulate, “issues for which uniform or coordinated resolution is reasonably necessary to facilitate interoperability, security and/or stability of the Internet, registrar services, registry services, or the DNS;” and “Examples of the above include, without limitation: principles for allocation of registered names in a TLD (e.g., first-come/first-served, timely renewal, holding period after expiration);”

3) Are there any “picket fence” considerations related to this purpose?

This purpose is related to WHOIS, which is within the Picket Fence. Specifically, Specification 1 of the Registry Agreement (Section 3.1(b)(iv) and (v) and Specification 4 of the Registrar Accreditation Agreement both refer to categories of issues and principles of allocation of registered names in a TLD.

Lawfulness of Processing Test:

Processing Activity:	Responsible Party: <small>(Charter Questions 3k, 3l, 3m)</small>	Lawful Basis: (Is the processing necessary to achieve the purpose?)
<p>1B-PA1: Collection of registration data to establish registrant’s rights in a domain name string (Charter Question 2b)</p>	<p>ICANN Registrars Registries</p>	<p>6(1)(b) for Registrars This is a 6(1)(b) purpose for Registrars because it is necessary to collect registrant data to allocate a string to a registrant. Without collecting minimal registrant data, the contracted party has no way of tracing the string back to registrant and is not able to deliver its side of the contract. 6(1)(f) for Registries and ICANN This is a 6(1)(f) purpose for Registries that require the collection of data to fulfill their terms, conditions and policies, this is a 6(1)(f) purpose. (NOTE: that registries collection of the data occurs only when the data is disclosed to them by the registrar as per 1B-PA2)</p>
<p>1B-PA2: Transmission of registration data from Registrar to Registry (Charter Questions 2c, 2d, 2e, 2i)</p>	<p>ICANN Registrars Registries</p>	<p>Registries may direct a Registrar to provide a limited data set, (i.e. data set that differs from the from the Minimum Data Set as required as per the relevant consensus policy), where such a Registry Operator , due to varying business model and legal interpretations of obligations, require an alternate data set to fulfill, in their subjective evaluation, their specific policies, terms and conditions (for example, for the purpose of administering the application of a Registry Acceptable Use Policy (AUP)) in cases where such policies exist. The disclosure of the data by the registrar to the registry is justified under 6(1)(b) (vis á vis the registrar’s processing) for the valid purpose of enabling the registry to then, where necessary, directly enforce the registration terms or acceptable use policy of the registry, where such a registry chooses to do so. Note: Joint controllership results in a required element of the RA (Spec 11) vs. the interpretation of the Registry, where in some instances this is not considered to be required as this is a RA pass on. It is also accepted that some registry operators have the ability to ‘choose’ how to interpret their obligations under Spec 11, and therefore this additional exercising of</p>

		<p>control would tend to suggest that registries retain a relationship closer to a Joint Controller in the realization of purpose 1B.</p> <p>(NOTE: the Registry's receipt of this data is the collection, as per 1B-PA1)</p>
<p>1B-PA3: Disclosure of registration data for lawful purposes</p> <p>(Charter Questions 2f (gating questions), 2j)</p>	<p>ICANN Registrars Registries</p>	<p>Establishing the rights of a RNH, and ensuring, subject to Terms & Conditions, that a RNH may exercise such benefits, may require disclosure of certain data elements, namely registrant details, IP addresses, domain names and name servers. The lawful basis would be 6(1)(f), should personal data be involved.</p>
<p>1B-PA4: Retention of registration data by Registrar, Registry</p> <p>(Charter Questions 2g)</p> <p>Note, this PA is not represented on the data elements table, because data processed above represents what data elements will be retained</p>	<p>ICANN Registrars Registries</p>	<p>This is a 6(1)(f) purpose because although there is likely a legitimate interest in providing mechanisms for safeguarding Registered Name Holders' Registration Data in the event of a dispute over ownership or an improper transfer, it is likely necessary for the registrar to retain the data to enforce their terms and conditions, however after the expiration of a domain, this retention is as per the register's own controllership.</p> <p>-----</p> <p>6(1)(f) for Registrars</p> <p>This is a 6(1)(f) purpose because although there is likely a legitimate interest in providing mechanisms for safeguarding Registered Name Holders' Registration Data in the event of a dispute over ownership or an improper transfer, it is not necessary from a technical perspective to retain the data in order to allocate a string to a registered name holder, and therefore is not necessary to perform the registration contract.</p> <p>The EPDP Team agreed to a period of one year following the life of the registration a registration as the retention period in order to conform with the Transfer Dispute Resolution Policy requirements. Refer to the details around retention in Recommendation #11</p> <p>6(1)(f) for Registries</p> <p>Registries need only retain data for the duration of the life of the domain.</p>

Data Flow Map:

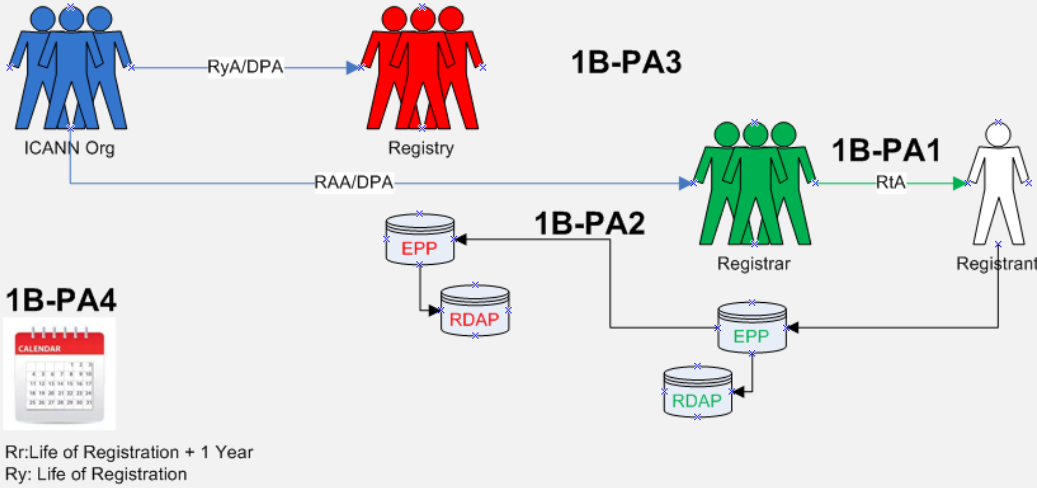

PURPOSE:

As subject to registry and registrar terms, conditions and policies, and ICANN consensus policies:

- (i) establish the rights of a Registered Name Holder in a registered name, and
- (ii) ensure that a Registered Name Holder may exercise its rights in the use, maintenance and disposition of the registered name.

Data Elements Matrix:

R = required
 O-RNH, O-Rr, O-CP = optional
 N/A=not applicable

Data Elements (Collected & Generated*)	Collection 1B-PA1	Transmission 1B-PA2	Disclosure 1B-PA3			
Domain Name	R	R	R			
Registry Domain ID*						
Registrar Whois Server* ⁷⁵	R	O-CP	O-CP			
Registrar URL*	R	O-CP	O-CP			
Updated Date*	R	O-CP	O-CP			

⁷⁵ "Registrar Whois Server", "Registrar URL", "Registrar Abuse Contact Email" and "Registrar Abuse Contact Phone" are not transmitted to the registry with each registration in EPP; they are provided to the registry once by each registrar and used for each registration a registrar has. I'm not sure if you want to flag this or not.

Data Elements (Collected & Generated*)	Collection 1B-PA1	Transmission 1B-PA2	Disclosure 1B-PA3			
Creation Date*						
Registry Expiry Date*						
Registrar Registration Expiration Date*	O-Rr	O-CP	O-CP			
Registrar*	R	R	R			
Registrar IANA ID*	R	R	R			
Registrar Abuse Contact Email*	R	O-CP	O-CP			
Registrar Abuse Contact Phone*	R	O-CP	O-CP			
Reseller*	O-Rr	O-CP	O-CP			
Domain Status(es)* ⁷⁶	R	O-CP	O-CP			
Registry Registrant ID*						
Registrant Fields						
<input type="checkbox"/> Name	R	O-CP	O-CP			
<input type="checkbox"/> Organization (opt.)	O-RNH	O-CP	O-CP			
<input type="checkbox"/> Street	R	O-CP	O-CP			
<input type="checkbox"/> City	R	O-CP	O-CP			
<input type="checkbox"/> State/province	R	O-CP	O-CP			
<input type="checkbox"/> Postal code	R	O-CP	O-CP			
<input type="checkbox"/> Country	R	O-CP	O-CP			
<input type="checkbox"/> Phone	R	O-CP	O-CP			
<input type="checkbox"/> Phone ext (opt.)						
<input type="checkbox"/> Fax (opt.)						
<input type="checkbox"/> Fax ext (opt.)						
<input type="checkbox"/> Email	R	O-CP	O-CP			
2nd E-Mail address						
Admin ID*						
Admin Fields						
<input type="checkbox"/> Name						
<input type="checkbox"/> Organization (opt.)						
<input type="checkbox"/> Street						
<input type="checkbox"/> City						
<input type="checkbox"/> State/province						
<input type="checkbox"/> Postal code						
<input type="checkbox"/> Country						
<input type="checkbox"/> Phone						
<input type="checkbox"/> Phone ext (opt.)						
<input type="checkbox"/> Fax (opt.)						

⁷⁶ "Domain Status" (which is a field that can appear multiple times) may or may not be set by the registrar; some status are set by the registrar, some are set by the registry.

Data Elements (Collected & Generated*)	Collection 1B-PA1	Transmission 1B-PA2	Disclosure 1B-PA3			
<input type="checkbox"/> Fax ext (opt.)						
<input type="checkbox"/> Email						
Tech ID*						
Tech Fields						
<input type="checkbox"/> Name						
<input type="checkbox"/> Organization (opt.)						
<input type="checkbox"/> Street						
<input type="checkbox"/> City						
<input type="checkbox"/> State/province						
<input type="checkbox"/> Postal code						
<input type="checkbox"/> Country						
<input type="checkbox"/> Phone						
<input type="checkbox"/> Phone ext (opt.)						
<input type="checkbox"/> Fax (opt.)						
<input type="checkbox"/> Fax ext (opt.)						
<input type="checkbox"/> Email						
NameServer(s)						
DNSSEC						
Name Server IP Address						
Last Update of Whois Database*						

2

PURPOSE:

Contributing to the maintenance of the security, stability, and resiliency of the Domain Name System in accordance with ICANN’s mission through enabling responses to lawful data disclosure requests.

Purpose Rationale:

1) If the purpose is based on an ICANN contract, cite the relevant section of the ICANN contracts that corresponds to the above purpose, if any.

- RAA - <https://www.icann.org/resources/pages/approved-with-specs-2013-09-17-en>

Yes, this purpose is lawful based on ICANN’s mission to coordinate the allocation and assignment of names in the root zone of the Domain Name System. Specifically, ICANN contracts reference the requirement for the maintenance of and access to accurate and up-to-date information concerning domain name registrations.

2) Is the purpose in violation with ICANN's bylaws?

No, it is not in violation of ICANN’s Bylaws, see ICANN Bylaws - Section 1.1(d)(ii), Section 1.2(a), Section 4.6(e)(i), Annex G1 and G2.

3) Are there any “picket fence” considerations related to this purpose?

This is within the Picket Fence, as the purpose specially refers to data already collected.

The WHOIS system, including 3rd party access, is within the Picket Fence, note specifically the Consensus Policies and Temporary Policies specification in the Registrar Accreditation Agreement (RAA) 1.3.4. maintenance of and access to accurate and up-to-date information concerning Registered Names and name servers; Registry Agreement (RA) - maintenance of and access to accurate and up-to-date information concerning domain name registrations.

Lawfulness of Processing Test:

Processing Activity:	Responsible Party: <small>(Charter Questions 3k, 3l, 3m)</small>	Lawful Basis: (Is the processing necessary to achieve the purpose?)
<p>2-PA1: Collection of registration data by Registrar</p> <p>(Charter Question 2b)</p>	<p>ICANN Registrars Registries</p>	<p>The lawful basis for this processing activity is Art.6(1)(f) of the GDPR because although there may be a legitimate interest in disclosing non-public RDDS/WHOIS to third parties (such as law enforcement, IP interests, etc.), this disclosure is not technically necessary to perform the registration contract between the registrant and registrar.</p>

		(NOTE: that registries collection of the data occurs only when the data is disclosed to them by the registrar as per 2-PA2)
<p>2-PA2: Transmission of registration data from Registrar to Registry</p> <p>(Charter Questions 2c, 2d, 2e, 2i)</p>	<p>ICANN Registrars Registries</p>	<p>This would be a 6(1)(f) processing activity because while there may be a legitimate interest in third parties contacting the registrant (for example, to inform the registrant or designee of a technical issue with the domain name), this is not necessary for the performance of the contract from a registry perspective.</p> <p>(NOTE: the Registry's receipt of this data is the collection, as per 2-PA1)</p>
<p>2-PA3: Disclosure of non-public, already collected, registration data to third parties</p> <p>(Charter Questions 2f (gating questions), 2j)</p>	<p>ICANN Registrars Registries Third Parties</p>	<p>This is a 6(1)(f) processing activity because although there may be a legitimate interest in disclosing non-public RDDS/WHOIS to third parties (such as law enforcement, IP interests, etc.), this disclosure is not technically necessary to perform the registration contract between the registrant and registrar.</p> <p>(Note: the requisite balancing test must be performed for each third-party type of disclosure and not for all registration data all the time.)</p>
<p>2-PA4: Retention of registration data by registrar</p> <p>Note, this PA is not represented on the data elements table, because data processed above represents what data elements will be retained</p> <p>(Charter Questions 2g)</p>	<p>ICANN Registrars Registries</p>	<p>This processing activity is not required for the Purpose of providing lawful disclosures and further relies on retention as documented in Purpose 1A & 1B.</p>

Data Flow Map:

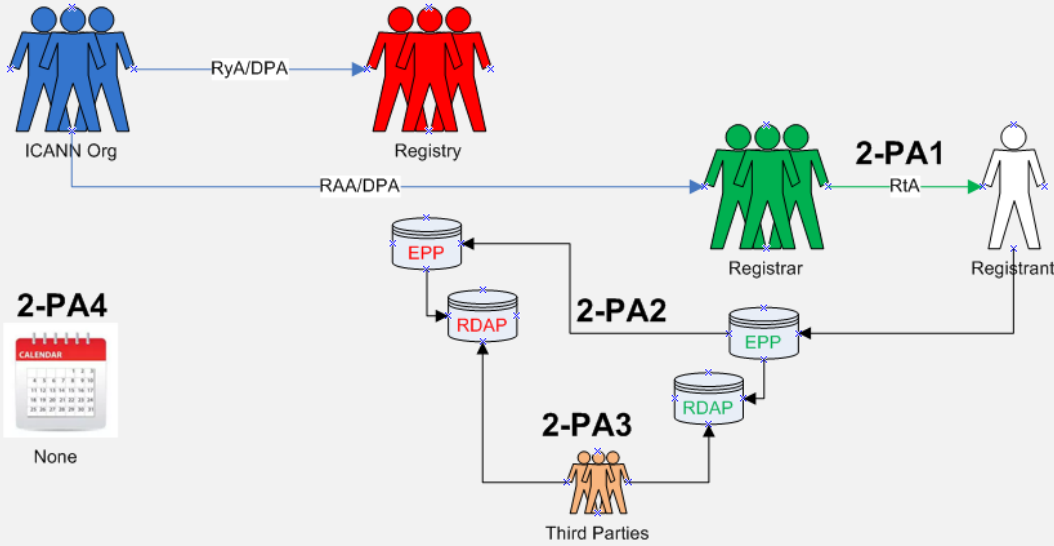

PURPOSE:

Contributing to the maintenance of the security, stability, and resiliency of the Domain Name System in accordance with ICANN's mission through enabling responses to lawful data disclosure requests.

Data Elements Matrix:

R = required
 O-RNH, O-Rr, O-CP = optional
 N/A=not applicable

Data Element (Collected & Generated*)	Collection 2-PA1	Transmission 2-PA2	Disclosure 2-PA3			
Domain Name	R	R	R			
Registry Domain ID*		R	R			
Registrar Whois Server*	R	R	R			
Registrar URL*	R	R	R			
Updated Date*	R	R	R			
Creation Date*		R	R			
Registry Expiry Date*		R	R			
Registrar Registration Expiration Date*	O-Rr	O-CP	O-CP			
Registrar*	R	R	R			
Registrar IANA ID*	R	R	R			

Data Element (Collected & Generated*)	Collection 2-PA1	Transmission 2-PA2	Disclosure 2-PA3			
Registrar Abuse Contact Email*	R	R	R			
Registrar Abuse Contact Phone*	R	R	R			
Reseller*	O-Rr	O-CP	O-CP			
Domain Status(es)*	R	R	R			
Registry Registrant ID*		R	R			
Registrant Fields						
<input type="checkbox"/> Name	R	R	R			
<input type="checkbox"/> Organization (opt.)	O-RNH	O-CP	O-CP			
<input type="checkbox"/> Street	R	R	R			
<input type="checkbox"/> City	R	R	R			
<input type="checkbox"/> State/province	R	R	R			
<input type="checkbox"/> Postal code	R	R	R			
<input type="checkbox"/> Country	R	R	R			
<input type="checkbox"/> Phone	R	R	R			
<input type="checkbox"/> Phone ext (opt.)						
<input type="checkbox"/> Fax (opt.)						
<input type="checkbox"/> Fax ext (opt.)						
<input type="checkbox"/> Email??	R	R	R			
2nd E-Mail address						
Admin ID*						
Admin Fields						
<input type="checkbox"/> Name						
<input type="checkbox"/> Organization (opt.)						
<input type="checkbox"/> Street						
<input type="checkbox"/> City						
<input type="checkbox"/> State/province						
<input type="checkbox"/> Postal code						
<input type="checkbox"/> Country						
<input type="checkbox"/> Phone						
<input type="checkbox"/> Phone ext (opt.)						
<input type="checkbox"/> Fax (opt.)						
<input type="checkbox"/> Fax ext (opt.)						
<input type="checkbox"/> Email						
Tech ID*		O-CP	O-CP			
Tech Fields						
<input type="checkbox"/> Name	O-RNH	O-CP	O-CP			

⁷⁷ Per the current temp spec requirement: 2.5.1. Registrar MUST provide an email address or a web form to facilitate email communication with the relevant contact, but MUST NOT identify the contact email address or the contact itself.

Data Element (Collected & Generated*)	Collection 2-PA1	Transmission 2-PA2	Disclosure 2-PA3			
<input type="checkbox"/> Organization (opt.)						
<input type="checkbox"/> Street						
<input type="checkbox"/> City						
<input type="checkbox"/> State/province						
<input type="checkbox"/> Postal code						
<input type="checkbox"/> Country						
<input type="checkbox"/> Phone	O-RNH	O-CP	O-CP			
<input type="checkbox"/> Phone ext (opt.)						
<input type="checkbox"/> Fax (opt.)						
<input type="checkbox"/> Fax ext (opt.)						
<input type="checkbox"/> Email	O-RNH	O-CP	O-CP			
NameServer(s)	O-RNH	O-RNH	O-RNH			
DNSSEC		O-RNH	O-RNH			
Name Server IP Address	O-RNH	O-RNH	O-RNH			
Last Update of Whois Database*		R	R			

3

PURPOSE:

Enable communication with the Registered Name Holder on matters relating to the Registered Name.

Purpose Rationale:

1) If the purpose is based on an ICANN contract, cite the relevant section of the ICANN contracts that corresponds to the above purpose, if any.

Yes, this purpose is lawful based on ICANN’s mission to coordinate the allocation and assignment of names in the root zone of the Domain Name System. Specifically, section 3.7.7.3 of the RAA refers to providing and updating contact information to facilitate timely resolution of any problems that arise in connection with the Registered Name.

2) Is the purpose in violation with ICANN's bylaws?

No, it is not in violation of ICANN’s Bylaws. Specifically, Article 1, Section 1.1 Mission (a)(i) Coordinates the allocation and assignment of names in the root zone of the Domain Name System ("DNS") and coordinates the development and implementation of policies concerning the registration of second-level domain names in generic top-level domains ("gTLDs"). In this role, ICANN's scope is to coordinate the development and implementation of policies <https://www.icann.org/resources/pages/governance/bylaws-en/#article1>.

Further, Articles G-1 and G-2 stipulate, “issues for which uniform or coordinated resolution is reasonably necessary to facilitate interoperability, security and/or stability of the Internet, registrar services, registry services, or the DNS;” and “Examples of the above include, without limitation: principles for allocation of registered names in a TLD (e.g., first-come/first-served, timely renewal, holding period after expiration);”.

3) Are there any “picket fence” considerations related to this purpose?

This purpose is related to WHOIS, which is within the Picket Fence. Specifically, Specification 1 of the Registry Agreement and Specification 4 of the Registrar Accreditation Agreement both refer to categories of issues and principles of allocation of registered names in a TLD.

Lawfulness of Processing Test:

Processing Activity:	Responsible Party: (Charter Questions 3k, 3l, 3m)	Lawful Basis: (Is the processing necessary to achieve the purpose?)
<p>3-PA1: Collection of registration data by Registrars</p> <p>(Charter Question 2b)</p>	<p>ICANN Registrars Registries</p>	<p>For Registrars 6(1)(b) - For registrars: This is a 6(1)(b) purpose because it is necessary to collect registrant data so that the registrar can contact the registrant in the event a communication is necessary to maintain the domain operation.</p> <p>For Registries 6(1)(f) - For third parties who would like to report technical issues to a technical contact: This would be a 6(1)(f) purpose because while there may be a legitimate interest in third parties contacting the registrant (for example, to inform the registrant or designee of a technical issue with the domain name), this is not necessary for the performance of the contract.</p>
<p>3-PA2: Transmission of registration data from Registrar to Registry</p> <p>(Charter Questions 2c, 2d, 2e, 2i)</p>	<p>N/A</p>	<p>This processing activity is not applicable. The transfer of data from the Registrar to the Registry is not necessary to still enable Registry communication with the Registered Name Holder.</p> <p>Note that while a “transfer” of registration data as documented here is not required, the Registry will have still received non-public data as part of the registration process in EPP.</p>
<p>3-PA3: Disclosure of registration data to enable communication with RNH</p> <p>(Charter Questions 2f (gating questions), 2j)</p>	<p>ICANN Registrars Registries RNH</p>	<p>In compliance with GDPR, non-public information must not be improperly disclosed and when it is, it is only for a lawful and specific purpose.</p> <p>Occurs, for example, when responding to court orders.</p> <p>This processing activity occurs via publication as noted in 3-PA4 by Registrars and Registries. This will not be reflected as a column in the data elements table below.</p>
<p>3-PA4: Publication of public, already collected, registration data to Internet Users</p>	<p>ICANN Registrars Registries Internet Users</p>	<p>A minimum public data set of registration data will be made available for query of gTLD second level domains in a freely accessible directory. Where a data element has been designated as non-public, it will be redacted, see 3-PA6.⁷⁸</p>

⁷⁸ Refer to recommendation #8 in regards to redaction and more information pertaining to a minimum public data set.

(Charter Questions 2f (gating questions), 2j)		In the data elements table below, take note of two columns, one for Registrars and one for Registries.
3-PA5: Redaction of registration data to Internet Users	ICANN Registrars Registries Internet Users	In compliance with GDPR, non-public information must not be improperly disclosed and when it is, it is only for a lawful and specific purpose. ⁷⁹
3-PA6: Retention of registration data Note, this PA is not represented on the data elements table, because data processed above represents what data elements will be retained	ICANN Registrars Registries	N/A – A retention period of registration data is not required to meet the intent of this purpose.
(Charter Questions 2g)		

Data Flow Map:

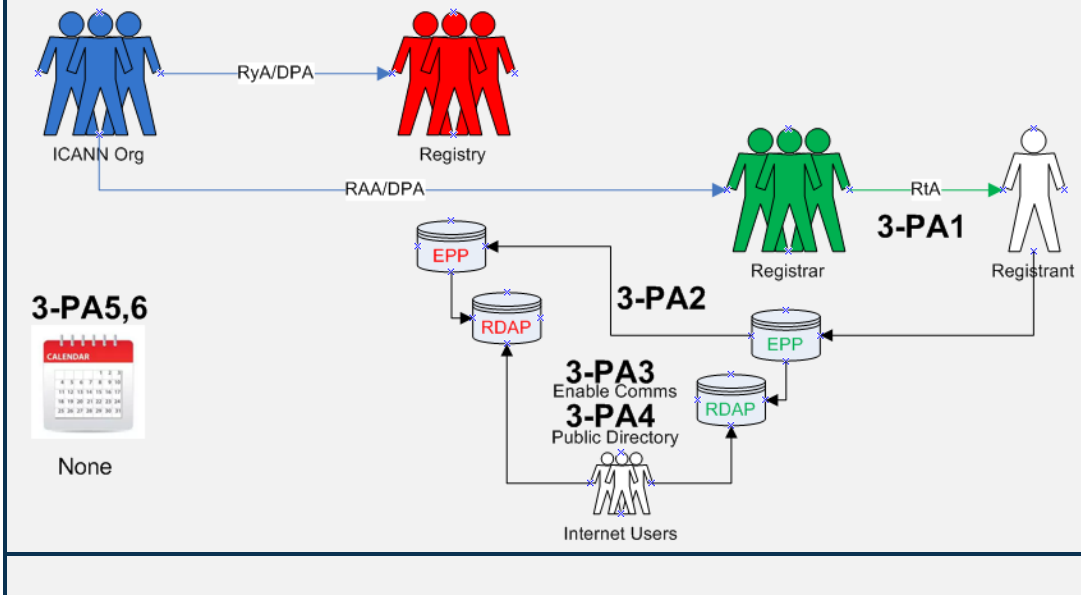

⁷⁹ idem

PURPOSE:

Enable communication with the Registered Name Holder on matters relating to the Registered Name.

Data Elements Matrix:

R = required
 O-RNH, O-Rr, O-CP = optional
 N/A=not applicable

Data Element (Collected & Generated*)	Collection 3-PA1	Transmission 3-PA2	Publication (registry) 3-PA4	Publication (registrar) 3-PA4	Redaction 3-PA5
Domain Name	R	R	R	R	No
Registry Domain ID*		R	R	R	Yes
Registrar Whois Server*	R	R	R	R	No
Registrar URL*	R	R	R	R	No
Updated Date*	R	R	R	R	No
Creation Date*		R	R	R	No
Registry Expiry Date*		R	R	R	No
Registrar Registration Expiration Date*	O-Rr	O-CP	O-CP	O-CP	No
Registrar*	R	R	R	R	No
Registrar IANA ID*	R	R	R	R	No
Registrar Abuse Contact Email*	R	R	R	R	No
Registrar Abuse Contact Phone*	R	R	R	R	No
Reseller*	O-Rr	O-CP	O-CP	O-CP	No
Domain Status(es)*	R	R	R	R	No
Registry Registrant ID*		R	R	R	Yes
Registrant Fields					
<input type="checkbox"/> Name	R	O-CP	O-CP	R	Yes
<input type="checkbox"/> Organization (opt.)	O-RNH	O-CP	O-CP	O-RNH	Yes ⁸⁰
<input type="checkbox"/> Street	R	O-CP	O-CP	R	Yes
<input type="checkbox"/> City	R	O-CP	O-CP	R	Yes ⁸¹
<input type="checkbox"/> State/province	R	O-CP	O-CP	R	No
<input type="checkbox"/> Postal code	R	O-CP	O-CP	R	Yes
<input type="checkbox"/> Country	R	O-CP	O-CP	R	No
<input type="checkbox"/> Phone	R	O-CP	O-CP	R	Yes

⁸⁰ Refer to Recommendation #13 about publication and redaction of the Organization field

⁸¹ Refer to Recommendation #12 about the redaction of the city field.

Data Element (Collected & Generated*)	Collection 3-PA1	Transmission 3-PA2	Publication (registry) 3-PA4	Publication (registrar) 3-PA4	Redaction 3-PA5
<input type="checkbox"/> Phone ext (opt.)					
<input type="checkbox"/> Fax (opt.)					
<input type="checkbox"/> Fax ext (opt.)					
<input type="checkbox"/> Email	R	O-CP	O-CP	R	Yes ⁸²
2nd E-Mail address					
Admin ID*					
Admin Fields					
<input type="checkbox"/> Name					
<input type="checkbox"/> Organization (opt.)					
<input type="checkbox"/> Street					
<input type="checkbox"/> City					
<input type="checkbox"/> State/province					
<input type="checkbox"/> Postal code					
<input type="checkbox"/> Country					
<input type="checkbox"/> Phone					
<input type="checkbox"/> Phone ext (opt.)					
<input type="checkbox"/> Fax (opt.)					
<input type="checkbox"/> Fax ext (opt.)					
<input type="checkbox"/> Email					
Tech ID*		O-CP	O-CP	R	Yes
Tech Fields					
<input type="checkbox"/> Name	O-RNH	O-CP	O-CP	R	Yes
<input type="checkbox"/> Organization (opt.)					
<input type="checkbox"/> Street					
<input type="checkbox"/> City					
<input type="checkbox"/> State/province					
<input type="checkbox"/> Postal code					
<input type="checkbox"/> Country					
<input type="checkbox"/> Phone	O-RNH	O-CP	O-CP	R	Yes
<input type="checkbox"/> Phone ext (opt.)					
<input type="checkbox"/> Fax (opt.)					
<input type="checkbox"/> Fax ext (opt.)					
<input type="checkbox"/> Email	O-RNH	O-CP	O-CP	R	Yes ⁸³
NameServer(s)	O-RNH	O-RNH	O-RNH	O-RNH	No
DNSSEC	O-RNH	O-RNH	O-RNH	O-RNH	No

⁸² Refer to recommendation #14 about how web forms and email addresses are used here for publication and communication.

⁸³ Refer to recommendation #14 about how web forms and email addresses are used here for publication and communication.

Deleted: 9 February 2019

Data Element (Collected & Generated*)	Collection 3-PA1	Transmission 3-PA2	Publication (registry) 3-PA4	Publication (registrar) 3-PA4	Redaction 3-PA5
Name Server IP Address	O-RNH	O-RNH	O-RNH	O-RNH	No
Last Update of Whois Database*	R	R	R	R	No

4A

PURPOSE:

--For Registrars Only--

Provide mechanisms for safeguarding Registered Name Holders' Registration Data in the event of a business or technical failure of a Registrar or Registry Operator, or unavailability of a Registrar or Registry Operator, as described in the RAA and RA, respectively.

Purpose Rationale:

1) If the purpose is based on an ICANN contract, cite the relevant section of the ICANN contracts that corresponds to the above purpose, if any.

- Registrar Data Escrow Program: <https://www.icann.org/resources/pages/registrar-data-escrow-2015-12-01-en>
- Data Fields Source: <https://www.icann.org/en/system/files/files/rde-specs-09nov07-en.pdf>

Escrowing the data is supported by ICANN's mandate to provide for security and stability in the DNS and this purpose is primarily protecting the registrant's rights. Escrow exists because Registrants have a reasonable expectation of business continuity.

It is reasonable to expect that a DPA would consider the escrow of customer data critical to the delivery of the service being provided to be common business practice and legal under GDPR provided appropriate contractual relationships are in place with the escrow agent to ensure that the data, once transferred to the escrow agent is afforded appropriate protection.

While technical and business resiliency could be achieved via other mechanisms, the escrow of data necessary to deliver the service is a generally accepted practice that is likely to be considered necessary to achieve the purpose of "...safeguarding registered name holder's registration data in the event of a business or technical failure, or other unavailability..."

While all contracted parties that have to be compliant with GDPR need to make sure there are protections against data loss and mechanisms to enable swift data recovery, ICANN is operating at the global level where customers can register domain names with registrars globally and the registry operators are based in numerous jurisdictions, it is important to have interoperability of escrow agents. Requiring all contracted parties to use the same policies for both escrowing data and applying the same standards to escrow agents for making data available, is necessary for contingency planning at the global level.

2) Is the purpose in violation with ICANN's bylaws?

No, providing a safety net for registrants in the event of registry technical or business failure seems within ICANN's remit.

1.1(a)(i) Coordinates the allocation and assignment of names in the root zone of the Domain Name System ("DNS") and coordinates the development and implementation of policies concerning the registration of second-level

domain names in generic top-level domains ("gTLDs"). In this role, ICANN's scope is to coordinate the development and implementation of policies:

- For which uniform or coordinated resolution is reasonably necessary to facilitate the openness, interoperability, resilience, security and/or stability of the DNS including, with respect to gTLD registrars and registries, policies in the areas described in Annex G-1 and Annex G-2; and
- That are developed through a bottom-up consensus-based multistakeholder process and designed to ensure the stable and secure operation of the Internet's unique names systems.

The issues, policies, procedures, and principles addressed in Annex G-1 and Annex G-2 with respect to gTLD registrars and registries shall be deemed to be within ICANN's Mission.

3) Are there any "picket fence" considerations related to this purpose?

Only with respect to the data model(s) defined within RDDS/Whois consensus policies. Agreements between ICANN and escrow providers are not within scope of the picket fence.

Lawfulness of Processing Test:

Processing Activity:	Responsible Party: <small>(Charter Questions 3k, 3l, 3m)</small>	Lawful Basis: <small>(Is the processing necessary to achieve the purpose?)</small>
<p>4A-PA1: Collection of registration data by Registrar</p> <p><small>(Charter Question 2b)</small></p>	<p>ICANN Registrars</p>	<p>6(1)(f)</p> <p>This Processing Activity of Collection is not required to be documented within the Purpose for Registrar Escrow because the processing activity for transmission of registration data to the Data Escrow Agent (as noted below) has already been collected or generated from other ICANN Purposes that also contain processing activities for the collection of registration data.</p> <p>However, the transparency of collection to the Registrant/Data Subject for the purpose of escrow is required. Refer to the Purpose for establishing the rights of the Registered Name Holder.</p>
<p>4A-PA2: Transmission of registration data to Data Escrow Agent</p> <p><small>(Charter Questions 2c, 2d, 2e, 2i)</small></p>	<p>ICANN Registrars Data Escrow Agent</p>	<p>This is a 6(1)(f) lawful basis because although there is likely a legitimate interest in providing mechanisms for safeguarding Registered Name Holders' Registration Data in the event of a business or technical failure, or other unavailability of a Registrar or Registry Operator, it is not technically necessary to transmit data to an escrow agent in order to allocate a string to a registered name holder, and is therefore not necessary to perform the registration contract.</p>

<p>4A-PA3: Disclosure of registration data to Gaining Registrar</p> <p>(Charter Questions 2f (gating questions), 2j)</p>	<p>ICANN Data Escrow Agent Gaining Registrar</p>	<p>This is a 6(1)(f) lawful basis because although there is likely a legitimate interest in providing mechanisms for safeguarding Registered Name Holders' Registration Data in the event of a business or technical failure, or other unavailability of a Registrar or Registry Operator, it is not technically necessary to transmit data to an escrow agent in order to allocate a string to a registered name holder, and is therefore not necessary to perform the registration contract.</p> <p>Data is not made public for escrow purposes, but a transfer to the escrow agent and - in case of contingencies - the transfer to a Gaining Registrar is required to ensure that operations are not impaired.</p> <p>How and who ICANN chooses as the Gaining Registrar may have additional implications to the lawfulness should the Gaining Registrar not reside within the EU when the Losing Registrar did reside within the EU.</p>
<p>4A-PA4: Retention of registration data by Data Escrow Agent</p> <p>Note, this PA is not represented on the data elements table, because data processed above represents what data elements will be retained</p> <p>(Charter Questions 2g)</p>	<p>ICANN Data Escrow Agent</p>	<p>This is a 6(1)(f) lawful basis due to the connection of Retention with Transmission of registration data to the Data Escrow Agent from the Registry.</p> <p>From the Escrow Specification (3.3.1.6), deposits to Third-Party Escrow Agents two copies are held for one year.</p> <p>Questions about the validity of the one year for TPP, noting that no retention is listed for ICANN approved vendors, given that once a new deposit occurs and is verified, it renders prior deposits useless.</p> <p>The EPDP also discussed that perhaps some minimal retention could be necessary from an overall continuity perspective.⁸⁴</p>

⁸⁴ Refer to the preliminary recommendation on Retention of Purpose E-Ry. A retention change should be validated to ensure technical requirements are not jeopardized by lowering the retention duration.

Data Flow Map:

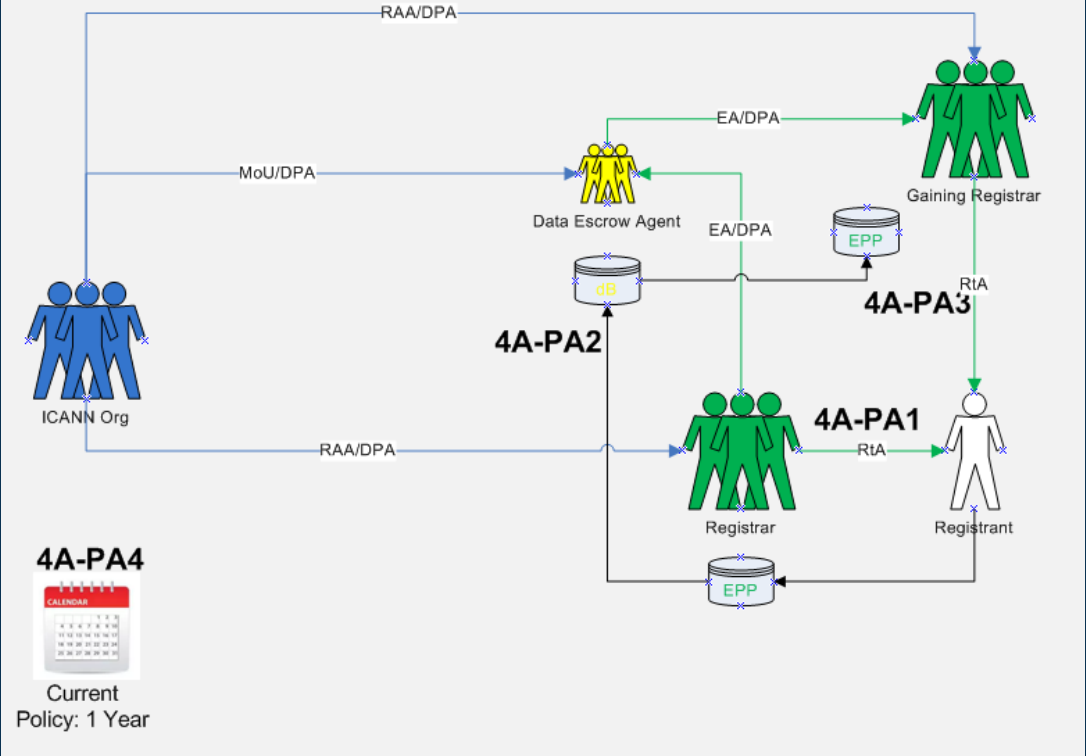

PURPOSE:

--For Registrars Only--

Provide mechanisms for safeguarding Registered Name Holders' Registration Data in the event of a business or technical failure of a Registrar or Registry Operator, or unavailability of a Registrar or Registry Operator, as described in the RAA and RA, respectively.

Data Elements Matrix:

R = required
 O-RNH, O-Rr, O-CP = optional
 N/A=not applicable

Data Element (Collected & Generated*)	Collection 4A-PA1	Transmission 4A-PA2	Disclosure 4A-PA3			
Domain Name	R	R ⁸⁵	R			
Registry Domain ID*						
Registrar Whois Server*						
Registrar URL*						
Updated Date*						
Creation Date*						
Registry Expiry Date*						
Registrar Registration Expiration Date*	O-Rr	R	R			
Registrar*	R	R	R			
Registrar IANA ID*						
Registrar Abuse Contact Email*						
Registrar Abuse Contact Phone*						
Reseller*	O-Rr	R	R			
Domain Status(es)*						
Registry Registrant ID*						
Registrant Fields						
<input type="checkbox"/> Name	R	R	R			
<input type="checkbox"/> Organization (opt.)						
<input type="checkbox"/> Street	R	R	R			
<input type="checkbox"/> City	R	R	R			
<input type="checkbox"/> State/province	R	R	R			
<input type="checkbox"/> Postal code	R	R	R			
<input type="checkbox"/> Country	R	R	R			
<input type="checkbox"/> Phone	R	R	R			
<input type="checkbox"/> Phone ext (opt.)						
<input type="checkbox"/> Fax (opt.)						
<input type="checkbox"/> Fax ext (opt.)						
<input type="checkbox"/> Email	R	R	R			
2nd E-Mail address						
Admin ID*						
Admin Fields						
<input type="checkbox"/> Name						
<input type="checkbox"/> Organization (opt.)						
<input type="checkbox"/> Street						
<input type="checkbox"/> City						
<input type="checkbox"/> State/province						

⁸⁵ Note, the fields identified here came from what is listed in the 2013 RAA, RDE Specification for Escrow. While a Registrar may process other data elements, only this minimal data set is required to recover registration data that is made ready for a Gaining Registrar to operate.

Data Element (Collected & Generated*)	Collection 4A-PA1	Transmission 4A-PA2	Disclosure 4A-PA3			
<input type="checkbox"/> Postal code						
<input type="checkbox"/> Country						
<input type="checkbox"/> Phone						
<input type="checkbox"/> Phone ext (opt.)						
<input type="checkbox"/> Fax (opt.)						
<input type="checkbox"/> Fax ext (opt.)						
<input type="checkbox"/> Email						
Tech ID*						
Tech Fields						
<input type="checkbox"/> Name						
<input type="checkbox"/> Organization (opt.)						
<input type="checkbox"/> Street						
<input type="checkbox"/> City						
<input type="checkbox"/> State/province						
<input type="checkbox"/> Postal code						
<input type="checkbox"/> Country						
<input type="checkbox"/> Phone						
<input type="checkbox"/> Phone ext (opt.)						
<input type="checkbox"/> Fax (opt.)						
<input type="checkbox"/> Fax ext (opt.)						
<input type="checkbox"/> Email						
NameServer(s)						
DNSSEC						
Name Server IP Address						
Last Update of Whois Database*						

4B

PURPOSE:**--For Registries Only--**

Provide mechanisms for safeguarding Registered Name Holders' Registration Data in the event of a business or technical failure of a Registrar or Registry Operator, or unavailability of a Registrar or Registry Operator, as described in the RAA and RA, respectively.

Purpose Rationale:

1) If the purpose is based on an ICANN contract, cite the relevant section of the ICANN contracts that corresponds to the above purpose, if any.

- Registry EBERO Program - <https://www.icann.org/resources/pages/ebero-2013-04-02-en>
- Registry Data Escrow Specification: <https://newgtlds.icann.org/sites/default/files/agreements/agreement-approved-31jul17-en.html#specification2>
- Data Fields Sources:
 - <http://tools.ietf.org/html/draft-arias-noguchi-registry-data-escrow>
 - <https://tools.ietf.org/html/draft-arias-noguchi-dnrd-objects-mapping-09>

Escrowing the data is supported by ICANN's mandate to provide for security and stability in the DNS and this purpose is primarily protecting the registrant's rights. Escrow exists because Registrants have a reasonable expectation of business continuity.

It is reasonable to expect that a DPA would consider the escrow of customer data critical to the delivery of the service being provided to be common business practice and legal under GDPR provided appropriate contractual relationships are in place with the escrow agent to ensure that the data, once transferred to the escrow agent is afforded appropriate protection.

While technical and business resiliency could be achieved via other mechanisms, the escrow of data necessary to deliver the service is a generally accepted practice that is likely to be considered necessary to achieve the purpose of "...safeguarding registered name holder's registration data in the event of a business or technical failure, or other unavailability..."

While all contracted parties that have to be compliant with GDPR need to make sure there are protections against data loss and mechanisms to enable swift data recovery, ICANN is operating at the global level where customers can register domain names with registrars globally and the registry operators are based in numerous jurisdictions, it is important to have interoperability of escrow agents. Requiring all contracted parties to use the same policies for both escrowing data and applying the same standards to escrow agents for making data available, is necessary for contingency planning at the global level.⁸⁶

⁸⁶ Draft Recommendation: Data processing agreements are necessary to ensure GDPR compliance. Recognizing that different escrow agreements exist depending on the TLD, the working group recommends that ICANN and/or the registry review the applicable escrow agreement and where necessary negotiate new GDPR compliant escrow agreements.

Within the Temporary Specification, EBERO is mentioned as Processing Activity under Appendix C. The Charter Question, Part 2i, tasks the EPDP to consider if this Processing Activity should be eliminated or adjusted. Based on initial research of the EBERO process, Registry Escrow is invoked as a component of the overall process with no indication that registration data other than what is identified here is transferred within any of the other EBERO components. The EPDP concluded that documentation of EBERO can be satisfied within the processing activities defined for this purpose of Registry Escrow.

2) Is the purpose in violation with ICANN's bylaws?

No, providing a safety net for registrants in the event of registry technical or business failure seems within ICANN's remit.

1.1(a)(i) Coordinates the allocation and assignment of names in the root zone of the Domain Name System ("DNS") and coordinates the development and implementation of policies concerning the registration of second-level domain names in generic top-level domains ("gTLDs"). In this role, ICANN's scope is to coordinate the development and implementation of policies:

- For which uniform or coordinated resolution is reasonably necessary to facilitate the openness, interoperability, resilience, security and/or stability of the DNS including, with respect to gTLD registrars and registries, policies in the areas described in Annex G-1 and Annex G-2; and
- That are developed through a bottom-up consensus-based multistakeholder process and designed to ensure the stable and secure operation of the Internet's unique names systems.

The issues, policies, procedures, and principles addressed in Annex G-1 and Annex G-2 with respect to gTLD registrars and registries shall be deemed to be within ICANN's Mission.

3) Are there any "picket fence" considerations related to this purpose?

Only with respect to the data model(s) defined within RDDS/Whois consensus policies. Agreements between ICANN and Data Escrow Providers are not within scope of the picket fence.

Lawfulness of Processing Test:

Processing Activity:	Responsible Party: <small>(Charter Questions 3k, 3l, 3m)</small>	Lawful Basis: <small>(Is the processing necessary to achieve the purpose?)</small>
4B-PA1: Collection of registration data by Registry <small>(Charter Question 2b)</small>	ICANN Registries	6(1)(f) This Processing Activity of Collection is not required to be documented within the Purpose for Registry Escrow because the processing activity for transmission of registration data to the Data Escrow Agent (as noted below) has already been collected or generated from other ICANN Purposes that also contain Processing Activities for the transfer of registration data from the Registrar to the Registry.

		However, the transparency of collection to the Registrant/Data Subject for the purpose of escrow is required. Refer to the Purpose for establishing the rights of the Registered Name Holder.
4B-PA2: Transmission of registration data to Data Escrow Agent (Charter Questions 2c, 2d, 2e, 2i)	ICANN Registries Data Escrow Agent	This is a 6(1)(f) lawful basis because although there is likely a legitimate interest in providing mechanisms for safeguarding Registered Name Holders' Registration Data in the event of a business or technical failure, or other unavailability of a Registrar or Registry Operator, it is not technically necessary to transmit data to an escrow agent in order to allocate a string to a registered name holder, and is therefore not necessary to perform the registration contract.
4B-PA3: Disclosure of registration data to EBERO Provider (Charter Questions 2f (gating questions), 2j)	ICANN Data Escrow Agent EBERO Provider	This is a 6(1)(f) lawful basis because although there is likely a legitimate interest in providing mechanisms for safeguarding Registered Name Holders' Registration Data in the event of a business or technical failure, or other unavailability of a Registrar or Registry Operator, it is not technically necessary to transmit data to an escrow agent in order to allocate a string to a registered name holder, and is therefore not necessary to perform the registration contract. Specification 2, Part B "Legal Requirements", #6 under "Integrity and Confidentiality" stipulates how the release of a deposit is made. How and who ICANN chooses as the EBERO Provider may have additional implications to the lawfulness should the EBERO Provider not reside within the EU when the Losing Registry did reside within the EU.
4B-PA4: Disclosure of registration data to Gaining Registry (Charter Questions 2f (gating questions), 2j)	ICANN EBERO Provider Gaining Registry	This is a 6(1)(f) lawful basis because although there is likely a legitimate interest in providing mechanisms for safeguarding Registered Name Holders' Registration Data in the event of a business or technical failure, or other unavailability of a Registrar or Registry Operator, it is not technically necessary to transmit data to an escrow agent in order to allocate a string to a registered name holder, and is therefore not necessary to perform the registration contract. Specification 2, Part B "Legal Requirements", #6 under "Integrity and Confidentiality" stipulates how the release of a deposit is made.

<p>4B-PA5: Retention of registration data by Data Escrow Agent</p> <p>Note, this PA is not represented on the data elements table, because data processed above represents what data elements will be retained</p> <p>(Charter Questions 2g)</p>	<p>ICANN Data Escrow Agent</p>	<p>This is a 6(1)(f) lawful basis due to the connection between the Retention processing activity with that of the Transmission of registration data to the Data Escrow Agent from the Registry.</p> <p>Specification 2, Part B “Legal Requirements”, #4 under “Integrity and Confidentiality” stipulates “(iii) keep and safeguard each Deposit for one (1) year.”</p> <p>Once a full escrow deposit has been successfully received and validated by the escrow agent, any previous deposits are obsolete and of no value. In the event of differential deposits, a 1-week retention would be required. The working group recommends that a 1 month minimum retention period by the escrow agent be established to provide an additional buffer against technical failure by the escrow agent.⁸⁷</p>
<p>4B-PA6: Retention of registration data by EBERO Provider</p> <p>Note, this PA is not represented on the data elements table, because data processed above represents what data elements will be retained</p> <p>(Charter Questions 2g)</p>	<p>ICANN EBERO Provider</p>	<p>This processing activity needs to be investigated further. Refer to language listed under 4B-PA5.</p> <p>Current policy is one year.</p>

⁸⁷ This preliminary recommendation should be validated to ensure technical requirements are not jeopardized by lowering the retention duration.

Data Flow Map:

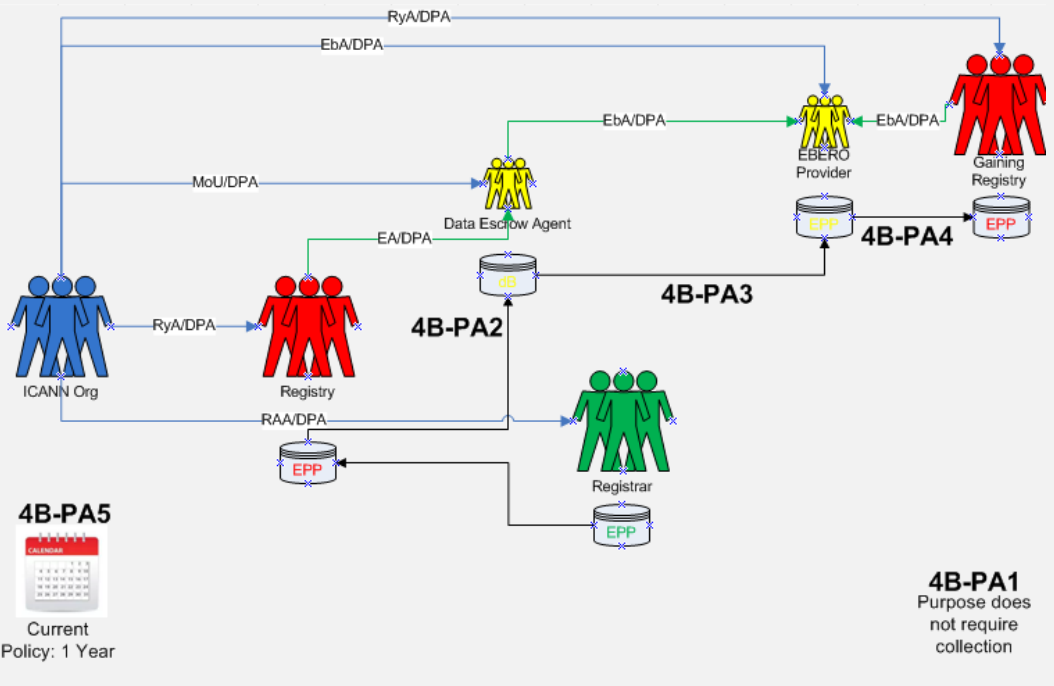

PURPOSE:

--For Registries Only--

Provide mechanisms for safeguarding Registered Name Holders' Registration Data in the event of a business or technical failure of a Registrar or Registry Operator, or unavailability of a Registrar or Registry Operator, as described in the RAA and RA, respectively.

Data Elements Matrix:

R = required
 O-RNH, O-Rr, O-CP = optional
 N/A=not applicable

Data Element (Collected & Generated*)	Collection 4B-PA1	Transmission 4B-PA2	Disclosure 4B-PA3	Disclosure 4B-PA4		
Domain Name	R ⁸⁸	R	R	R		
Registry Domain ID*	R	R	R	R		
Registrar Whois Server*	R	R	R	R		
Registrar URL*	R	R	R	R		
Updated Date*	R	R	R	R		
Creation Date*	R	R	R	R		
Registry Expiry Date*	R	R	R	R		
Registrar Registration Expiration Date*	O-CP	O-CP	O-CP	O-CP		
Registrar*	R	R	R	R		
Registrar IANA ID*	R	R	R	R		
Registrar Abuse Contact Email*	R	R	R	R		
Registrar Abuse Contact Phone*	R	R	R	R		
Reseller*	O-CP	O-CP	O-CP	O-CP		
Domain Status(es)*	R	R	R	R		
Registry Registrant ID*	R	R	R	R		
Registrant Fields						
<input type="checkbox"/> Name	O-CP	O-CP	O-CP	O-CP		
<input type="checkbox"/> Organization (opt.)	O-CP	O-CP	O-CP	O-CP		
<input type="checkbox"/> Street	O-CP	O-CP	O-CP	O-CP		
<input type="checkbox"/> City	O-CP	O-CP	O-CP	O-CP		
<input type="checkbox"/> State/province	O-CP	O-CP	O-CP	O-CP		
<input type="checkbox"/> Postal code	O-CP	O-CP	O-CP	O-CP		
<input type="checkbox"/> Country	O-CP	O-CP	O-CP	O-CP		
<input type="checkbox"/> Phone	O-CP	O-CP	O-CP	O-CP		
<input type="checkbox"/> Phone ext (opt.)	O-CP	O-CP	O-CP	O-CP		
<input type="checkbox"/> Fax (opt.)	O-CP	O-CP	O-CP	O-CP		
<input type="checkbox"/> Fax ext (opt.)	O-CP	O-CP	O-CP	O-CP		
<input type="checkbox"/> Email	O-CP	O-CP	O-CP	O-CP		
2nd E-Mail address						
Admin ID*						
Admin Fields						
<input type="checkbox"/> Name						
<input type="checkbox"/> Organization (opt.)						
<input type="checkbox"/> Street						
<input type="checkbox"/> City						

⁸⁸ Purpose E-Ry, Escrow for Registries depends on the collection of all registration data across all purposes. The 4B-PA1 column is populated based on the total compilation of data collected across the six other purposes by Registries. Transparency of collection to the Registrant (Data Subject) is a requirement for purpose of escrow.

Data Element (Collected & Generated*)	Collection 4B-PA1	Transmission 4B-PA2	Disclosure 4B-PA3	Disclosure 4B-PA4		
<input type="checkbox"/> State/province						
<input type="checkbox"/> Postal code						
<input type="checkbox"/> Country						
<input type="checkbox"/> Phone						
<input type="checkbox"/> Phone ext (opt.)						
<input type="checkbox"/> Fax (opt.)						
<input type="checkbox"/> Fax ext (opt.)						
<input type="checkbox"/> Email						
Tech ID*	O-CP	O-CP	O-CP	O-CP		
Tech Fields						
<input type="checkbox"/> Name	O-CP	O-CP	O-CP	O-CP		
<input type="checkbox"/> Organization (opt.)						
<input type="checkbox"/> Street						
<input type="checkbox"/> City						
<input type="checkbox"/> State/province						
<input type="checkbox"/> Postal code						
<input type="checkbox"/> Country						
<input type="checkbox"/> Phone	O-CP	O-CP	O-CP	O-CP		
<input type="checkbox"/> Phone ext (opt.)						
<input type="checkbox"/> Fax (opt.)						
<input type="checkbox"/> Fax ext (opt.)						
<input type="checkbox"/> Email	O-CP	O-CP	O-CP	O-CP		
NameServer(s)	O-RNH	O-RNH	O-RNH	O-RNH		
DNSSEC	O-RNH	O-RNH	O-RNH	O-RNH		
Name Server IP Address	O-RNH	O-RNH	O-RNH	O-RNH		
Last Update of Whois Database*						
· Additional data elements as identified by Registry Operator in its registration policy, such as (i) status as Registry Operator Affiliate or Trademark Licensee [.MICROSOFT]; (ii) membership in community [.ECO]; (iii) licensing, registration or appropriate permits [.PHARMACY, .LAW] place of domicile [.NYC]; (iv) business entity or activity [.BANK, .BOT]	O-CP	O-CP	O-CP	O-CP		

5

PURPOSE:

- i) Handle contractual compliance monitoring requests and audit activities consistent with the terms of the Registry agreement and the Registrar accreditation agreements and any applicable data processing agreements, by processing specific data only as necessary;
- i) Handle compliance complaints initiated by ICANN, or third parties consistent with the terms of the Registry agreement and the Registrar accreditation agreements.

Purpose Rationale:

1) If the purpose is based on an ICANN contract, cite the relevant section of the ICANN contracts that corresponds to the above purpose, if any.

RA - <https://newgtlds.icann.org/sites/default/files/agreements/agreement-approved-31jul17-en.html>

Registry:

- 2.2 Compliance with Consensus Policies and Temporary Policies
- 2.11 Contractual and Operational Compliance Audits
- Specification 4, 3.1 Periodic Access to Thin Registration Data
- Specification 11 Public Interest Commitments

RAA - <https://www.icann.org/resources/pages/approved-with-specs-2013-09-17-en>

Registrar:

- Registrar Obligations - 3.4.3, 3.7.7
- 3.15 Registrar Self-Assessment and Audits
- 4.1 Compliance with Consensus Policies and Temporary Policies
- Data Retention Specification, 2.

If a contractual compliance complaint is filed, the complainant provides certain information regarding the issue, which may contain personal data. Depending on the nature of the issue, ICANN Compliance may ask the Registrar or Registry Operator for the minimum data needed to investigate the complaint. Compliance may also look at the public WHOIS to supplement its review or processing.

For ICANN Contractual Compliance audits, ICANN sends audit questionnaires to Registry Operators and Registrars. In responding to the questionnaire, the Registry Operator and Registrar could include personal data in its responses. Further, to allow ICANN to carry out accuracy audits of registration contact data, ICANN may request from Registry Operators and Registrars the minimum data for randomly selected registrations.

Also, as part of Registry Operator audits, ICANN Contractual Compliance requests escrowed data to cross-reference information between data escrow and zone file and bulk registration data access for a sample of 25 domain names to ensure consistency.

2) Is the purpose in violation with ICANN's bylaws?

No. Per ICANN's Mission, Section 1.1(a)(i):

“...In this role, ICANN’s scope is to coordinate the development and implementation of policies: ...That are developed through a bottom-up consensus-based multistakeholder process and designed to ensure the stable and secure operation of the Internet’s unique names systems. ..The issues, policies, procedures, and principles addressed in Annex G-1 and Annex G-2 with respect to gTLD registrars and registries shall be deemed to be within ICANN’s Mission.”

3) Are there any “picket fence” considerations related to this purpose?

No. Registration Directory Services is within the “picket fence” as noted in ICANN Mission and Bylaws and contracts with ICANN to Registries and Registrars.

Lawfulness of Processing Test:

Processing Activity:	Responsible Party: <small>(Charter Questions 3k, 3l, 3m)</small>	Lawful Basis: <small>(Is the processing necessary to achieve the purpose?)</small>
<p>5-PA1: Collection of registration data for compliance with ICANN contracts</p> <p>(Charter Question 2b)</p>	<p>ICANN Registrars Registries</p>	<p>This is a 6(1)(f) purpose because although there may be a legitimate interest in collecting registration data for ICANN org compliance to confirm compliance with the RAA/RA, this collection is not technically necessary to perform the registration contract.</p> <p>The BC and IPC disagree that Purpose 5 is a 6(1)(f) purpose. The Team tentatively agreed to the following: (a) 6(1)(f) is an appropriate legal basis for the compliance purpose; (b) Some (BC and IPC) believe Purpose F may be a 6(1)(b); (c) There are concerns that 6(1)(f) may cause issues where the controller determines that the privacy rights outweigh the legitimate interest and therefore data cannot be provided.</p>
<p>5-PA2: Transmission of registration data from Registrar to Registry</p> <p>(Charter Questions 2c, 2d, 2e, 2i)</p>	<p>N/A</p>	<p>This is a 6(1)(f) purpose because although there may be a legitimate interest in collecting registration data for ICANN org compliance to confirm compliance with the RAA/RA, this transmission is not technically necessary to perform the registration contract.</p>
<p>5-PA3: Transmission of registration data to ICANN org</p> <p>(Charter Questions 2c, 2d, 2e, 2i)</p>	<p>N/A</p>	<p>This is a 6(1)(f) purpose because although there may be a legitimate interest in transmitting registration data to ICANN org compliance to confirm compliance with the RAA/RA, this transmission is not technically necessary to perform the registration contract.</p> <p>(Note: the requisite balancing test must be performed for each third-party type of disclosure and not for all registration data all the time.)</p>

<p>5-PA4: Disclosure of registration data to ICANN org</p> <p>(Charter Questions 2f (gating questions), 2j)</p>	<p>N/A</p>	<p>This is a 6(1)(f) purpose because although there may be a legitimate interest in transmitting registration data to ICANN org compliance to confirm compliance with the RAA/RA, this disclosure is not technically necessary to perform the registration contract.</p> <p>(Note: the requisite balancing test must be performed for each third-party type of disclosure and not for all registration data all the time.)</p>
<p>5-PA5: Retention of registration data by ICANN org</p> <p>Note, this PA is not represented on the data elements table, because data processed above represents what data elements will be retained</p> <p>(Charter Questions 2g)</p>	<p>ICANN</p>	<p>May go beyond the life of registration in order to complete accuracy audit and compliance processing, not to exceed one year.</p>

Data Flow Map:

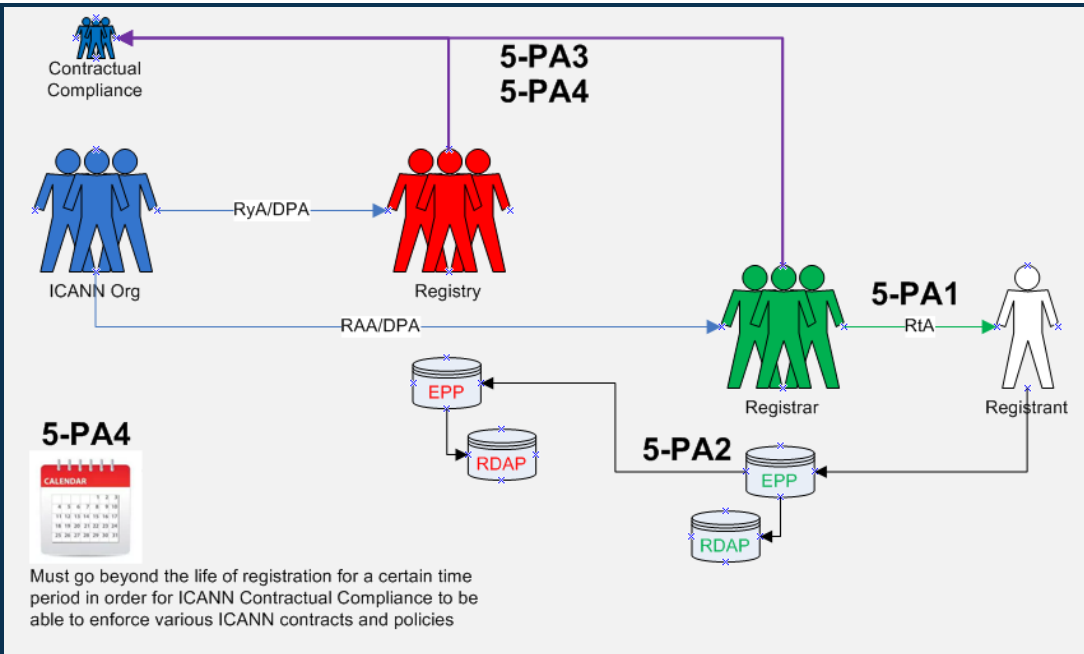

PURPOSE:

- i) Handle contractual compliance monitoring requests and audit activities consistent with the terms of the Registry agreement and the Registrar accreditation agreements and any applicable data processing agreements, by processing specific data only as necessary;
- ii) Handle compliance complaints initiated by ICANN, or third parties consistent with the terms of the Registry agreement and the Registrar accreditation agreements.

Data Elements Matrix:

R = required
 O-RNH, O-Rr, O-CP = optional
 N/A=not applicable

The data element designations below are not “automatic” transmission and disclosure activities as documented in Purposes 1, 3 and 4, that occur every time with every domain registration. Rather, these activities are processed as needed in accordance with the contracts.

Data Element (Collected & Generated*)	Collection 5-PA1	Transmission 5-PA2	Transmission (to ICANN) 5-PA3	Disclosure (to ICANN) 5-PA4		
Domain Name	R	R	R	R		
Registry Domain ID*		R	R	R		

Data Element (Collected & Generated*)	Collection 5-PA1	Transmission 5-PA2	Transmission (to ICANN) 5-PA3	Disclosure (to ICANN) 5-PA4		
Registrar Whois Server*	R	R	R	R		
Registrar URL*	R	R	R	R		
Updated Date*	R	R	R	R		
Creation Date*		R	R	R		
Registry Expiry Date*		R	R	R		
Registrar Registration Expiration Date*	O-Rr	O-CP	O-CP	O-CP		
Registrar*	R	R	R	R		
Registrar IANA ID*	R	R	R	R		
Registrar Abuse Contact Email*	R	R	R	R		
Registrar Abuse Contact Phone*	R	R	R	R		
Reseller*	O-Rr	O-CP	O-CP	O-CP		
Domain Status(es)*	R	R	R	R		
Registry Registrant ID*		R	R	R		
Registrant Fields						
<input type="checkbox"/> Name	R	R	R	R		
<input type="checkbox"/> Organization (opt.)	O-RNH	O-CP	O-CP	O-CP		
<input type="checkbox"/> Street	R	R	R	R		
<input type="checkbox"/> City	R	R	R	R		
<input type="checkbox"/> State/province	R	R	R	R		
<input type="checkbox"/> Postal code	R	R	R	R		
<input type="checkbox"/> Country	R	R	R	R		
<input type="checkbox"/> Phone	R	R	R	R		
<input type="checkbox"/> Phone ext (opt.)	O-RNH	O-CP	O-CP	O-CP		
<input type="checkbox"/> Fax (opt.)	O-RNH	O-CP	O-CP	O-CP		
<input type="checkbox"/> Fax ext (opt.)	O-RNH	O-CP	O-CP	O-CP		
<input type="checkbox"/> Email	R	R	R	R		
2nd E-Mail address						
Admin ID*						
Admin Fields						
<input type="checkbox"/> Name						
<input type="checkbox"/> Organization (opt.)						
<input type="checkbox"/> Street						
<input type="checkbox"/> City						
<input type="checkbox"/> State/province						
<input type="checkbox"/> Postal code						
<input type="checkbox"/> Country						
<input type="checkbox"/> Phone						
<input type="checkbox"/> Phone ext (opt.)						

Data Element (Collected & Generated*)	Collection 5-PA1	Transmission 5-PA2	Transmission (to ICANN) 5-PA3	Disclosure (to ICANN) 5-PA4		
<input type="checkbox"/> Fax (opt.)						
<input type="checkbox"/> Fax ext (opt.)						
<input type="checkbox"/> Email						
Tech ID*		O-CP	O-CP	OP-CP		
Tech Fields						
<input type="checkbox"/> Name	O-RNH	O-CP	O-CP	O-CP		
<input type="checkbox"/> Organization (opt.)						
<input type="checkbox"/> Street						
<input type="checkbox"/> City						
<input type="checkbox"/> State/province						
<input type="checkbox"/> Postal code						
<input type="checkbox"/> Country						
<input type="checkbox"/> Phone	O-RNH	O-CP	O-CP	O-CP		
<input type="checkbox"/> Phone ext (opt.)						
<input type="checkbox"/> Fax (opt.)						
<input type="checkbox"/> Fax ext (opt.)						
<input type="checkbox"/> Email	O-RNH	O-CP	O-CP	O-CP		
NameServer(s)	O-RNH	O-RNH	O-RNH	O-RNH		
DNSSEC	O-RNH	O-RNH	O-RNH	O-RNH		
Name Server IP Address	O-RNH	O-RNH	O-RNH	O-RNH		
Last Update of Whois Database*	R	R	R	R		

6

PURPOSE:

Operationalize policies for the resolution of disputes regarding or relating to the registration of domain names (as opposed to the use of such domain names, but including where such policies take into account use of the domain names), namely the UDRP, URS, PDDRP, RRD RP⁸⁹, and the TDRP.

Purpose Rationale:

1) If the purpose is based on an ICANN contract, cite the relevant section of the ICANN contracts that corresponds to the above purpose, if any.

- RAA - <https://www.icann.org/resources/pages/approved-with-specs-2013-09-17-en>
 - Section 3.8
- RyA - <https://newgtlds.icann.org/sites/default/files/agreements/agreement-approved-31jul17-en.html>
 - Specification 7

ICANN Org to provide EPDP Team with copy of agreements with UDRP/URS providers in relation to data protection / transfer of data as well as the relevant data protection policies that dispute resolution providers have in place.

Rights Protection Mechanisms (RPMs) provisions exist within both the Registry and Registrar agreements as connected to ICANN Bylaws. This purpose is connected to Rights Protection Mechanisms of Uniform Dispute Resolution Mechanism (UDRP) and Uniform Rapid Suspension (URS), but it does not preclude RPMs that could be created or modified in the future.

RRDRP and PDDRP RPMs were also considered whether they should be connected to this purpose. Because these DRPs have not been tested, their inclusion here is to act as a marker for future consideration if/when they are used.

2) Is the purpose in violation with ICANN's bylaws?

No.

ICANN bylaws, Section 1.1(a)(i), as a part of "Mission" refer to Annexes G1 and G2. Annex G-1 contains a provision for Registrars, "resolution of disputes regarding the registration of domain names (as opposed to the use of such domain names, but including where such policies take into account use of the domain names)" Annex G-2 also contains, "resolution of disputes regarding the registration of domain names (as opposed to the use of such domain names)".

3) Are there any "picket fence" considerations related to this purpose?

⁸⁹ The PDDRP and RRD RP have yet to be invoked as a dispute procedure. As such, it's not clear exactly which data elements are required to process a complaint. The processing activities and data elements tables are completed with UDRP, URS and TDRP in mind.

Resolution of disputes regarding or relating to the registration of domain names (as opposed to the use of such domain names) are considered within the picket fence for the development of consensus policies. The purpose and the processing hereunder, as specified by the collection, transmission and disclosure of the data elements identified, are considered within the picket fence based upon the coordination, operationalization and facilitation of the dispute resolution mechanisms listed. The Temp Spec (Appendix D & E) now makes reference to who an RPM provider must contact based on Thick or Thin RDS to obtain registration data for the complaint.

Lawfulness of Processing Test:

Processing Activity:	Responsible Party: <small>(Charter Questions 3k, 3l, 3m)</small>	Lawful Basis: (Is the processing necessary to achieve the purpose?)
6-PA1: Collection of registration data to implement the UDRP, URS and TDRP (Charter Question 2b)	ICANN Registrars	This is a 6(1)(b) purpose because it is necessary to collect registration data in order to implement a UDRP or URS decision. For example, in the case of a UDRP/URS proceeding, the Registrant must agree to be bound by the UDRP/URS in order to register a domain name, so the collection of data for this purpose is necessary to fulfill the registration agreement.
	ICANN Registries	This is a 6(1)(f) purpose because ICANN and Registries do not have a direct contract with the registrant. The Registry must process data to fulfill its obligations regarding the RPMs, compliance with which are incorporated into the Registry Agreement. Under Article 6(1)(f) with regard to the URS and UDRP for registries and ICANN, because the processing is necessary for the purposes of pursued legitimate interests that are not overridden by the interests or fundamental rights and freedoms of the data subject. ⁹⁰ With regard to this balancing test, we note that the contacts are important to ensure due process for the registrant so that they have notice of the proceedings and can avoid losing their domain name through a default. Note Registries collect this data as required per existing URS Rules and Procedures.
6-PA1Z: Collection of registration data to implement the RDDR and PDDR	ICANN Registries Registrars	This is a 6(1)(f) with regard to the RDDR and PDDR for registrars, registries, and ICANN, because the processing is necessary for the purposes of pursued legitimate interests that are not overridden by the interests or fundamental rights and freedoms of the data subject.

⁹⁰ Certain registrant contact information may be needed (e.g., in the UDRP context) for due process purposes in the registrant's benefit.

<p>Note: these two DRPs are not represented on the data elements table below.</p> <p>(Charter Question 2b)</p>		
<p>6-PA2: Transmission of registration data from Registrar to Registry</p> <p>(Charter Questions 2c, 2d, 2e, 2i)</p>	<p>ICANN Registrars</p>	<p>This is a 6(1)(b) purpose because transmission of (at least minimal) registration data from the Registrar to the Registry is necessary to identify the Registrant for purposes of dispute resolution.</p>
	<p>ICANN Registries</p>	<p>This is a 6(1)(f) purpose because although there is a legitimate interest in transmitting registration data to the Registry, this transmission is not technically necessary to perform the registration contract. The Registry must process data to fulfill its obligations regarding the RPMs and DRPs, compliance with which are incorporated into the Registry Agreement.</p>
<p>6-PA3: Transmission of registration data to Dispute Resolution Provider to administer the UDRP, URS, & TDRP</p> <p>(Charter Questions 2c, 2d, 2e, 2i)</p>	<p>ICANN Registrars Registries Dispute Resolution Provider</p>	<p>6(1)(b) for Registrars 6(1)(f) for Registries and ICANN</p> <p>This is a 6(1)(f) purpose because although there may be a legitimate interest in transmitting registration data to Dispute Resolution Providers, this transmission is not technically necessary to perform the registration contract.</p>
<p>6-PA3Z: Transmission of registration data to Dispute Resolution Provider to administer the RDDRP and PDDRP</p> <p>Note: these two DRPs are not represented on the data elements table below.</p> <p>(Charter Questions 2c, 2d, 2e, 2i)</p>	<p>ICANN Registrars Registries Dispute Resolution Provider</p>	<p>6(1)(b) for Registrars 6(1)(f) for Registries and ICANN</p> <p>This is a 6(1)(f) purpose because although there may be a legitimate interest in transmitting registration data to Dispute Resolution Providers, this transmission is not technically necessary to perform the registration contract.</p>
<p>6-PA4: Disclosure of registration data used for complaints to Complainant</p> <p>(Charter Questions 2f (gating questions), 2j)</p>	<p>ICANN Dispute Resolution Provider Complainant</p>	<p>6(1)(f). This activity allows for the filing of John Doe complaints and the ability to amend the complaint as needed with the proper Registrant data so that the proceeding can go forward. The provision of this data to the complainant is important to help ensure due process for the registrant: it allows the complainant to withdraw a URS/UDRP claim where it becomes clear from the identity of the registrant that they have a right or legitimate interest to use the name, or that they have not registered the name in bad faith. It also enables, in some</p>

		<p>circumstances, requests to consolidate related claims, which has cost-saving benefits for all parties. In addition, the provision of this information to complainants supports case settlement (roughly 20% of cases) saving all parties time and expense.</p>
<p>6-PA5: Publication of registration data used for complaints on Dispute Resolution Provider websites to Internet Users</p> <p>(Charter Questions 2f (gating questions), 2j)</p>	<p>ICANN Dispute Resolution Provider Internet Users</p>	<p>6(1)(f)</p> <p>WIPO’s GDPR FAQ: Paragraph 4(j) of the UDRP mandates that “[a]ll (successful and unsuccessful) decisions under this Policy will be published in full over the Internet, except when an Administrative Panel determines in an exceptional case to redact portions of its decision.” In this respect, through their acceptance of the applicable registration terms and conditions, domain name registrants subject to a UDRP proceeding are bound by this provision as well as the other UDRP terms. Publication of party names in UDRP decisions is essential to the overall functioning of the UDRP in that it helps to explain the panel’s findings, supports jurisprudential consistency, facilitates the conduct of other cases as appropriate, and furthermore can provide a deterrent effect. Against the background of the above-mentioned purposes, any request to redact a party’s name from a decision should normally be submitted for the panel’s consideration during the UDRP proceeding. Also in light of the above-mentioned reasons for full decision publication, any such request should be appropriately motivated.</p>
<p>6-PA6: Retention of registration data used for complaints by Dispute Resolution Providers</p> <p>Note, this PA is not represented on the data elements table, because data processed above represents what data elements will be retained</p> <p>(Charter Questions 2g)</p>	<p>ICANN Dispute Resolution Provider</p>	<p>6(1)(f)</p> <p>The EPDP Team is not aware of any current data retention requirements by dispute resolution providers.</p> <p>Retention⁹¹ of full registration data (See 6-PA3) by the Provider after the complaint has closed: Retention Period: TBD based on DRP data protection policies and transfer agreements in place between DRPs and ICANN.</p> <p>Retention of Complainant and Respondent data (See 6-PA5) such as Domain Name, Registrar, Name, Organization, City,</p>

⁹¹ It is difficult to know what the appropriate retention period should be, but on occasion a query from a losing registrant is sent claiming they were not aware of the complaint, and in those situations it is useful to be able to provide copies of correspondence which includes contact information and email address.

		<p>State Country, on the Provider Site displaying closed complaints: Retention Period: TBD based on DRP data protection policies and transfer agreements in place between DRPs and ICANN.</p>
<p>6-PA7: Retention of registration data used for complaints by Complainants</p> <p>Note, this PA is not represented on the data elements table, because data processed above represents what data elements will be retained</p> <p>(Charter Questions 2g)</p>	<p>ICANN Dispute Resolution Provider</p>	<p>This processing activity is listed because the role of the Complainant is defined in the Processing Activity 6-PA4.</p> <p>The IPC believes this Processing Activity is out of scope and should be deleted. This has yet to be explored in detail by the EPDP Plenary.</p>

Data Flow Map:

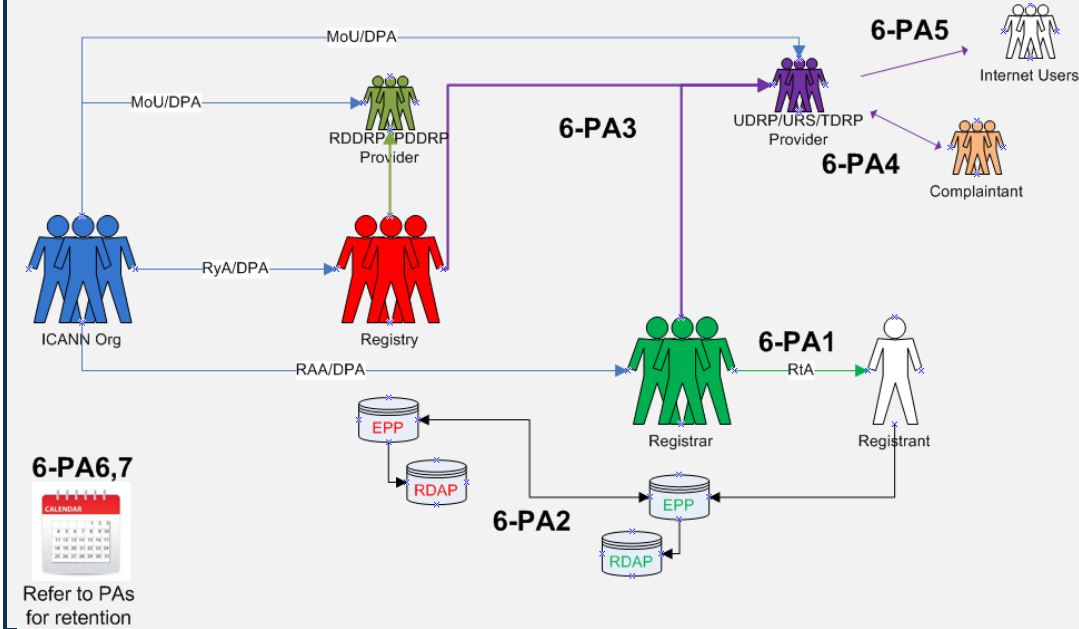

PURPOSE:

Operationalize policies for the resolution of disputes regarding or relating to the registration of domain names (as opposed to the use of such domain names, but including where such policies take into account use of the domain names), namely the UDRP, URS, PDDRP, RRDRP, and the TDRP.

Data Elements Matrix:

R = required
 O-RNH, O-Rr, O-CP = optional
 N/A=not applicable

Data Element (Collected & Generated*)	Collection 6-PA1	Transmission 6-PA2	Transmission 6-PA3	Disclosure 6-PA4	Publication 6-PA5	
Domain Name	R	R	R	R	R	
Registry Domain ID*						
Registrar Whois Server*	R	R	R	R		
Registrar URL*	R	R	R	R		
Updated Date*	R	R	R	R		
Creation Date*		R	R	R		
Registry Expiry Date*		R	R	R		
Registrar Registration Expiration Date*	O-Rr	O-CP	O-CP	R		
Registrar*	R	R	R	R	R	
Registrar IANA ID*	R	R	R	R		
Registrar Abuse Contact Email*	R	R	R	R		
Registrar Abuse Contact Phone*	R	R	R	R		
Reseller*	O-Rr	O-CP	O-CP	R		
Domain Status(es)*	R	R	R	R		
Registry Registrant ID*						
Registrant Fields						
☑ Name	R	R	R	R	R	
☑ Organization (opt.)	O-RNH	O-CP	O-CP	R	R	
☑ Street	R	R	R	R		
☑ City	R	R	R	R	R	
☑ State/province	R	R	R	R	R	
☑ Postal code	R	R	R	R		
☑ Country	R	R	R	R	R	
☑ Phone	R	R	R	R		
☑ Phone ext (opt.)	O-RNH	O-CP	O-CP	R		
☑ Fax (opt.)	O-RNH	O-CP	O-CP	R		
☑ Fax ext (opt.)	O-RNH	O-CP	O-CP	R		
☑ Email	R	R	R	R		
2nd E-Mail address						

Data Element (Collected & Generated*)	Collection 6-PA1	Transmission 6-PA2	Transmission 6-PA3	Disclosure 6-PA4	Publication 6-PA5	
Admin ID*						
Admin Fields						
<input type="checkbox"/> Name						
<input type="checkbox"/> Organization (opt.)						
<input type="checkbox"/> Street						
<input type="checkbox"/> City						
<input type="checkbox"/> State/province						
<input type="checkbox"/> Postal code						
<input type="checkbox"/> Country						
<input type="checkbox"/> Phone						
<input type="checkbox"/> Phone ext (opt.)						
<input type="checkbox"/> Fax (opt.)						
<input type="checkbox"/> Fax ext (opt.)						
<input type="checkbox"/> Email						
Tech ID*						
Tech Fields						
<input type="checkbox"/> Name						
<input type="checkbox"/> Organization (opt.)						
<input type="checkbox"/> Street						
<input type="checkbox"/> City						
<input type="checkbox"/> State/province						
<input type="checkbox"/> Postal code						
<input type="checkbox"/> Country						
<input type="checkbox"/> Phone						
<input type="checkbox"/> Phone ext (opt.)						
<input type="checkbox"/> Fax (opt.)						
<input type="checkbox"/> Fax ext (opt.)						
<input type="checkbox"/> Email						
NameServer(s)	O-RNH	O-RNH	O-RNH	R		
DNSSEC						
Name Server IP Address						
Last Update of Whois Database*	R	R	R	R		

7

PURPOSE:

Enabling validation to confirm that Registered Name Holder meets gTLD registration policy eligibility criteria voluntarily adopted by Registry Operator and that are described or referenced in the Registry Agreement for that gTLD.⁹²

Purpose Rationale:

1) If the purpose is based on an ICANN contract, is this lawful as tested against GDPR and other laws?

Yes. Registry Agreement allows Registry Operators to establish, publish, and adhere to clear registration policies (e.g., Spec. 11, 3(d); Spec. 12; Spec. 13). See also ICANN Bylaws (Art. 1.1(a)(i) and Annex G-2). Enabling validation to confirm that Registered Name Holder meets registration policy eligibility criteria introduces innovation and differentiation in the gTLD space.

2) Is the purpose in violation with ICANN's bylaws?

No. This purpose is consistent with ICANN's Mission of coordinating the development and implementation of policies concerning the registration of second-level domain names in gTLDs (Introduction of New gTLDs and Applicant Guidebook), and principles for allocation of registered names in a TLD (Annex G-2)

3) Are there any "picket fence" considerations related to this purpose?

This purpose is related to WHOIS, which is within the Picket Fence. Specifically, Specification 1 of the Registry Agreement (Section 3.1(b)(iv) and (v) and Specification 4 of the Registrar Accreditation Agreement both refer to categories of issues and principles of allocation of registered names in a TLD.

Lawfulness of Processing Test:

Processing Activity:	Responsible Party: <small>(Charter Questions 3k, 3l, 3m)</small>	Lawful Basis: (Is the processing necessary to achieve the purpose?)
<p>7-PA1: Collecting specific data for Registry Agreement-mandated eligibility requirements</p> <p>(Charter Question 2b)</p>	<p>Registries</p>	<p>6(1)(b) (for ICANN, registrars- or Registry-mandated eligibility requirements) because it is necessary to collect specific Registrant data to confirm the registrant meets the specific requirements of the registration agreement, i.e., registrar needs to verify the registrant is a licensed attorney to register a .abogado domain name.</p> <p>6(1)(f) for Registries, which are not parties to the registration agreement, but process the data in accordance with the</p>

⁹² The EPDP Team's approval of Purpose 7 does not prevent and should not be interpreted as preventing Registry Operators from voluntarily adopting gTLD registration policy eligibility criteria that are not described or referenced in their respective Registry Agreements.

		obligations under the Registry-Registrar Agreement to allocate and activate domain names for registered name holders that meet the registration policy eligibility requirements
7-PA2: Collecting specific data for Registry Operator-adopted eligibility requirements (Charter Question 2b)	Registries	6(1)(b) for Registrars because it is necessary to collect specific registrant data to confirm the registrant meets the specific requirements of the registration agreement, i.e., registrar needs to verify the registrant is a licensed attorney to register a .abogado domain name 6(1)(f) for Registries, which are not parties to the registration agreement, but process the data in accordance with the obligations under the Registry-Registrar Agreement to allocate and activate domain names for Registered Name Holders that meet the registration policy eligibility requirements
7-PA3: Transfer of registration data from registrar to registry (Charter Questions 2c, 2d, 2e, 2i)	RA-mandated eligibility requirements Registries	6(1)(b) for Registrars because transfer from Registrar to Registry of registration data elements that demonstrate satisfaction of registration policy eligibility criteria is necessary so that the registry may validate satisfaction of eligibility criteria, and comply with ICANN audit requests. 6(1)(f) for Registries. The transfer is necessary so that the Registry may validate satisfaction of eligibility criteria and comply with ICANN audit requests.
7-PA4: Transfer of registration data from registrar to registry (Charter Questions 2c, 2d, 2e, 2i)	Registry-adopted eligibility requirements Registries	6(1)(b) for registrars because transfer from registrar to registry of registration data elements that demonstrate satisfaction of registration policy eligibility criteria is necessary so that the registry may validate satisfaction of eligibility criteria. 6(1)(f) for registries. The transfer is necessary so that the registry may validate satisfaction of eligibility criteria and comply with ICANN audit requests.
7-PA5: Disclosure of registration data to Internet Users (Charter Questions 2f (gating questions), 2j)	Registries	A lawful basis needs to be further investigated and can vary depending on the eligibility requirement. Some Registry Operators, as part of their business model, may require the publication as part of their eligibility requirements and perhaps published in the freely available RDDS as noted under Purpose 3.

<p>7-PA6: Retention of registration data</p> <p>Note, this PA is not represented on the data elements table, because data processed above represents what data elements will be retained</p> <p>(Charter Questions 2g)</p>	<p>Registries</p>	<p>6(1)(f)</p> <p>Life of registration.</p>
---	-------------------	---

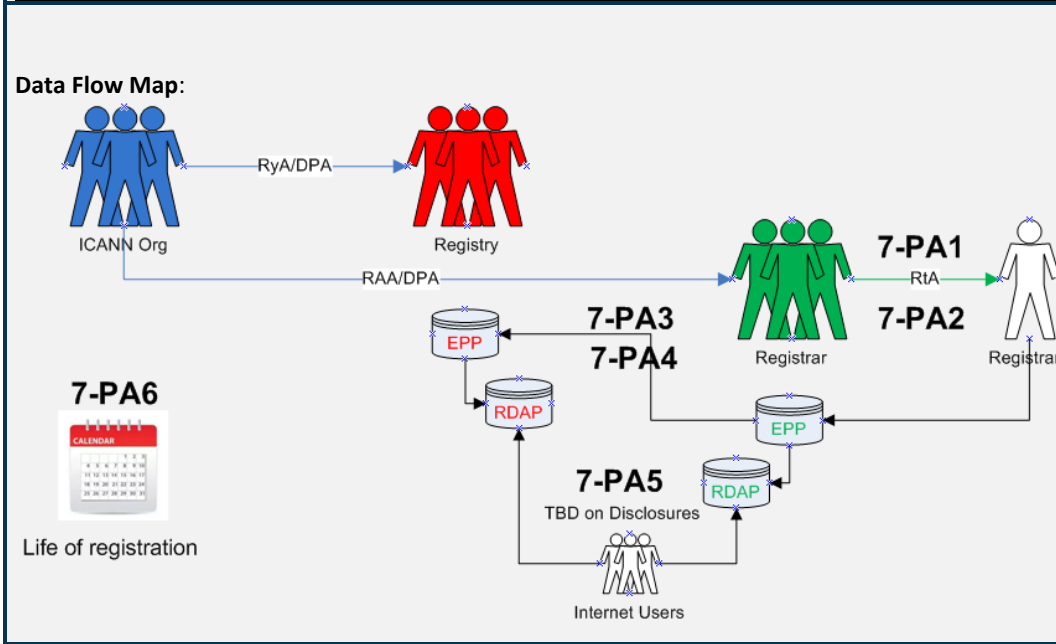

PURPOSE:
 Enabling validation to confirm that Registered Name Holder meets gTLD registration policy eligibility criteria voluntarily adopted by Registry Operator and that are described or referenced in the Registry Agreement for that gTLD.

Data Elements Matrix:
 R = required
 O-RNH, O-Rr, O-CP = optional
 N/A=not applicable

Data Element (Collected & Generated*)	Collection 7-PA1	Collection 7-PA2	Transmission 7-PA3	Transmission 7-PA4	Disclosure 7-PA5	
Domain Name						
Registry Domain ID*						
Registrar Whois Server*						
Registrar URL*						
Updated Date*						
Creation Date*						
Registry Expiry Date*						
Registrar Registration Expiration Date*						
Registrar*						
Registrar IANA ID*						
Registrar Abuse Contact Email*						
Registrar Abuse Contact Phone*						
Reseller*						
Domain Status(es)*						
Registry Registrant ID*						
Registrant Fields						
- Name						
- Organization (opt.)						
- Street						
- City						
- State/province						
- Postal code						
- Country						
- Phone						
- Phone ext (opt.)						
- Fax (opt.)						
- Fax ext (opt.)						
- Email						
2nd E-Mail address						
Admin ID*						
Admin Fields						
- Name						
- Organization (opt.)						
- Street						
- City						
- State/province						
- Postal code						
- Country						
- Phone						

Data Element (Collected & Generated*)	Collection 7-PA1	Collection 7-PA2	Transmission 7-PA3	Transmission 7-PA4	Disclosure 7-PA5	
- Phone ext (opt.)						
- Fax (opt.)						
- Fax ext (opt.)						
- Email						
Tech ID*						
Tech Fields						
- Name						
- Organization (opt.)						
- Street						
- City						
- State/province						
- Postal code						
- Country						
- Phone						
- Phone ext (opt.)						
- Fax (opt.)						
- Fax ext (opt.)						
- Email						
NameServer(s)						
DNSSEC						
Name Server IP Address						
Last Update of Whois Database*						
Other Data:						
- Additional data elements as identified by Registry Operator in its registration policy, such as (i) status as Registry Operator Affiliate or Trademark Licensee [MICROSOFT]; (ii) membership in community [ECO]; (iii) licensing, registration or appropriate permits [PHARMACY, LAW] place of domicile [NYC]; (iv) business entity or activity [BANK, BOT]	O-CP	O-CP	O-CP	O-CP	O-CP	

Annex E - Consensus Call Process and Designations to date (11 February 2019)

Below are the recommendations and the Chair’s designation as to the level of Consensus on each. Each contains the shorthand title and the wording of the recommendation in the final report. It is important to note that the shorthand title does not appear in the final report, just the recommendation itself plus the accompanying explanation that you can read in the currently posted version of the final report.

Also, the GNSO Guidelines for working group decision making are included below the tables.

In a slight contravention to the standard practice, the EPDP Team Chair has used the label, “Full Consensus / Consensus” as a signal to the GNSO Council that the EPDP Team has reached a consensus position on these issues but also as a salute to or indication of the degree of teamwork and compromise that has taken place. Either term has an equivalent on the Council discussion.

For those where no designations has been indicated, the consensus designation process it still ongoing.

<u>Purpose / Recommendation #</u>	<u>Chair Proposed / Team Reviewed Designation</u>
<u>Purpose 1 – Establish the rights of a Registered Name Holder</u>	<u>Full Consensus / Consensus</u>
<u>Purpose 2 – Maintaining SSR through enabling of lawful access</u>	<u>Full Consensus / Consensus</u>
<u>Purpose 3 – Enable communication with RNH</u>	<u>Full Consensus / Consensus</u>
<u>Purpose 4 – Safeguarding RNH's Registration Data</u>	<u>Full Consensus / Consensus</u>
<u>Purpose 5 – Handling Contractual Compliance</u>	<u>Full Consensus / Consensus</u>
<u>Purpose 6 – Resolution of DRPs</u>	<u>Full Consensus / Consensus</u>
<u>Purpose 7 – gTLD registration policy eligibility criteria</u>	<u>Full Consensus / Consensus</u>
<u>Recommendation #3 – Commitment to consider a system for Standardized Access to non-public Registration Data</u>	<u>Full Consensus / Consensus</u>
<u>Recommendation #4 – Requirements related to accuracy</u>	<u>Full Consensus / Consensus</u>
<u>Recommendation #6 – Consent to publish additional contact information</u>	<u>Full consensus / Consensus</u>

<u>Purpose / Recommendation #</u>	<u>Chair Proposed / Team Reviewed Designation</u>
<u>Recommendation #8 – Escrow Providers</u>	<u>Full consensus / Consensus</u>
<u>Recommendation #21 – URS / UDRP</u>	<u>Full Consensus / Consensus</u>
<u>Recommendation #22 – Instructions for RPM PDP WG</u>	<u>Full Consensus / Consensus</u>
<u>Recommendation #23 – Data processing agreements with dispute resolution providers</u>	<u>Full Consensus / Consensus</u>
<u>Recommendation #24 – Transfer Policy</u>	<u>Full Consensus / Consensus</u>
<u>Recommendation #25 – Input to Transfer Policy review</u>	<u>Full Consensus / Consensus</u>
<u>Recommendation #26 – Data processing agreements with non-Contracted Party entities involved in registration data processing</u>	<u>Full Consensus / Consensus</u>

Consensus designations not yet reviewed by the EPDP Team:

<u>Recommendation #</u>	<u>Chair Proposed Designation</u>
<u>Recommendation #2 – Additional Purposes</u>	
<u>Recommendation #5 – Data elements to be collected by Registrars</u>	<u>Full Consensus / Consensus</u>
<u>Recommendation #7 – Data elements to be transferred from Registrars to Registries</u>	<u>Full Consensus / Consensus</u>
<u>Recommendation #9 – Contractual Compliance</u>	<u>Full Consensus / Consensus</u>
<u>Recommendation #10 – Data Redaction</u>	<u>Full Consensus / Consensus</u>
<u>Recommendation #11 – City Field</u>	
<u>Recommendation #12 – Organization field</u>	<u>Full Consensus / Consensus</u>
<u>Recommendation #13 – Email communication</u>	
<u>Recommendation #14 – Privacy/Proxy Registrations</u>	<u>Full Consensus / Consensus</u>
<u>Recommendation #15 – Data retention</u>	
<u>Recommendation #16 – Geographic Basis</u>	<u>Full Consensus / Consensus</u>
<u>Recommendation #17 – Natural vs. legal</u>	<u>Full Consensus / Consensus</u>
<u>Recommendation #18 – Reasonable access</u>	
<u>Recommendation #19 – Controller Agreement</u>	
<u>Recommendation #20 – Responsible parties</u>	
<u>Recommendation #27 – Impact on other policies</u>	<u>Full Consensus / Consensus</u>

Recommendation #	Chair Proposed Designation
<u>Recommendation #28 – Implementation Transition Period</u>	
<u>Recommendation #29 – Admin Contact Transition</u>	<u>Full Consensus / Consensus</u>

For Reference:

GNSO WG Guidelines – SECTION 3.6 Standard Methodology for Making Decisions:

The Chair will be responsible for designating each position as having one of the following designations:⁹³

- **Full consensus** - when no one in the group speaks against the recommendation in its last readings. This is also sometimes referred to as **Unanimous Consensus**.
- **Consensus** - a position where only a small minority disagrees, but most agree.⁹⁴
- **Strong support but significant opposition** - a position where, while most of the group supports a recommendation, there are a significant number of those who do not support it.
- **Divergence** (also referred to as **No Consensus**) - a position where there isn't strong support for any particular position, but many different points of view. Sometimes this is due to irreconcilable differences of opinion and sometimes it is due to the fact that no one has a particularly strong or convincing viewpoint, but the members of the group agree that it is worth listing the issue in the report nonetheless.
- **Minority View** - refers to a proposal where a small number of people support the recommendation. This can happen in response to a **Consensus, Strong support but significant opposition, and No Consensus**; or, it can happen in cases where there is neither support nor opposition to a suggestion made by a small number of individuals.

⁹³ The designations “Full consensus,” “Consensus,” and “Strong support but significant opposition” may also be used to signify levels of “consensus against” a particular recommendation if the consensus position of the Working Group warrants it. If this is the case, any “Minority View” will be in favor of the particular recommendation. It is expected that designations of “consensus against” will be rare and Working Groups are encouraged to draft (and revise) recommendations so that a level of consensus can be expressed “for” rather than “against” a recommendation. However, it is recognized that there can be times when a “consensus against” designation is both appropriate and unavoidable as a practical matter. A “consensus against” position should be distinguished from a position of “Divergence” (or “No Consensus”), which is applied where no consensus has emerged either for or against a recommendation (i.e., the consensus level of the Working Group cannot be described as “Full consensus,” “Consensus” or “Strong support but significant opposition” either for or against a recommendation).

⁹⁴ For those that are unfamiliar with ICANN usage, you may associate the definition of ‘Consensus’ with other definitions and terms of art such as rough consensus or near consensus. It should be noted, however, that in the case of a GNSO PDP originated Working Group, all reports, especially Final Reports, must restrict themselves to the term ‘Consensus’ as this may have legal implications.

In cases of **Consensus**, **Strong support but significant opposition**, and **No Consensus**, an effort should be made to document that variance in viewpoint and to present any **Minority View** recommendations that may have been made. Documentation of **Minority View** recommendations normally depends on text offered by the proponent(s). In all cases of **Divergence**, the WG Chair should encourage the submission of minority viewpoint(s).

Page 12: [1] Deleted	Marika Konings	2/11/19 8:11:00 AM
-----------------------------	-----------------------	---------------------------

Page 46: [2] Deleted	Marika Konings	2/11/19 8:11:00 AM
-----------------------------	-----------------------	---------------------------