



IANA Stewardship Transition and Enhancing ICANN Accountability

Theresa Swinehart | 27 April 2016

The U.S. Government's Announcement

- 14 March 2014:** U.S. Government announces intent to transition its stewardship of the IANA functions to the global multistakeholder community
- ⦿ Asked ICANN to convene global stakeholders to develop a proposal
 - ⦿ The multistakeholder community has set policies implemented by ICANN for more than 15 years

**Why
now?**

The U.S. Government's announcement:

- ⦿ Marks the final phase of the privatization of the DNS
- ⦿ Further supports and enhances the multistakeholder model of Internet policy making and governance

ICANN was asked to serve as a facilitator, based on its role as the IANA functions administrator and global coordinator for the Internet's Domain Name System (DNS)

What are the IANA Functions?

The IANA Functions evolved in support of the Internet Engineering Task Force, and initially funded via research projects supported by the U. S. Department of Defense, Advance Research Projects Agency.

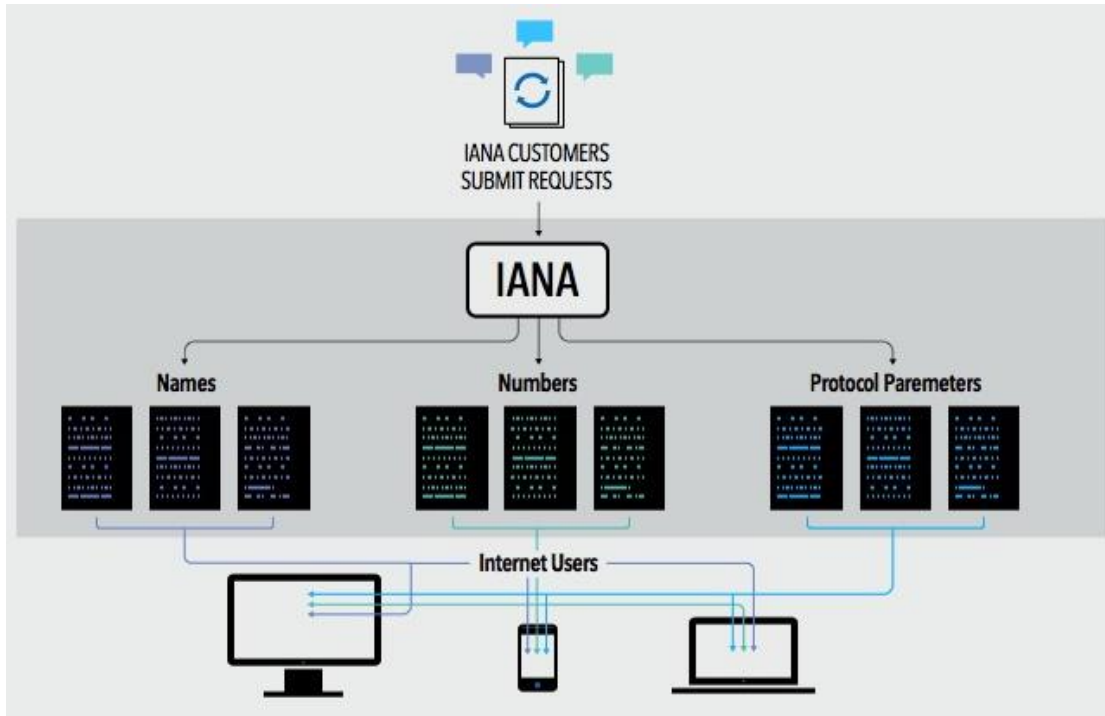

These functions include:

- ⊙ The coordination of the assignment of technical Internet protocol parameters
- ⊙ The administration of certain responsibilities associated with Internet DNS Root zone management
- ⊙ The allocation of Internet IP addresses

ICANN was created to perform the IANA Functions and has done so pursuant to a no-cost contract with the Department of Commerce for over 15 years

ICANN's Global Multistakeholder Community

Today's Community of Communities

In the same way the Internet is a network of networks comprised of computers and devices, the ICANN community is a community of communities comprised of people and organizations

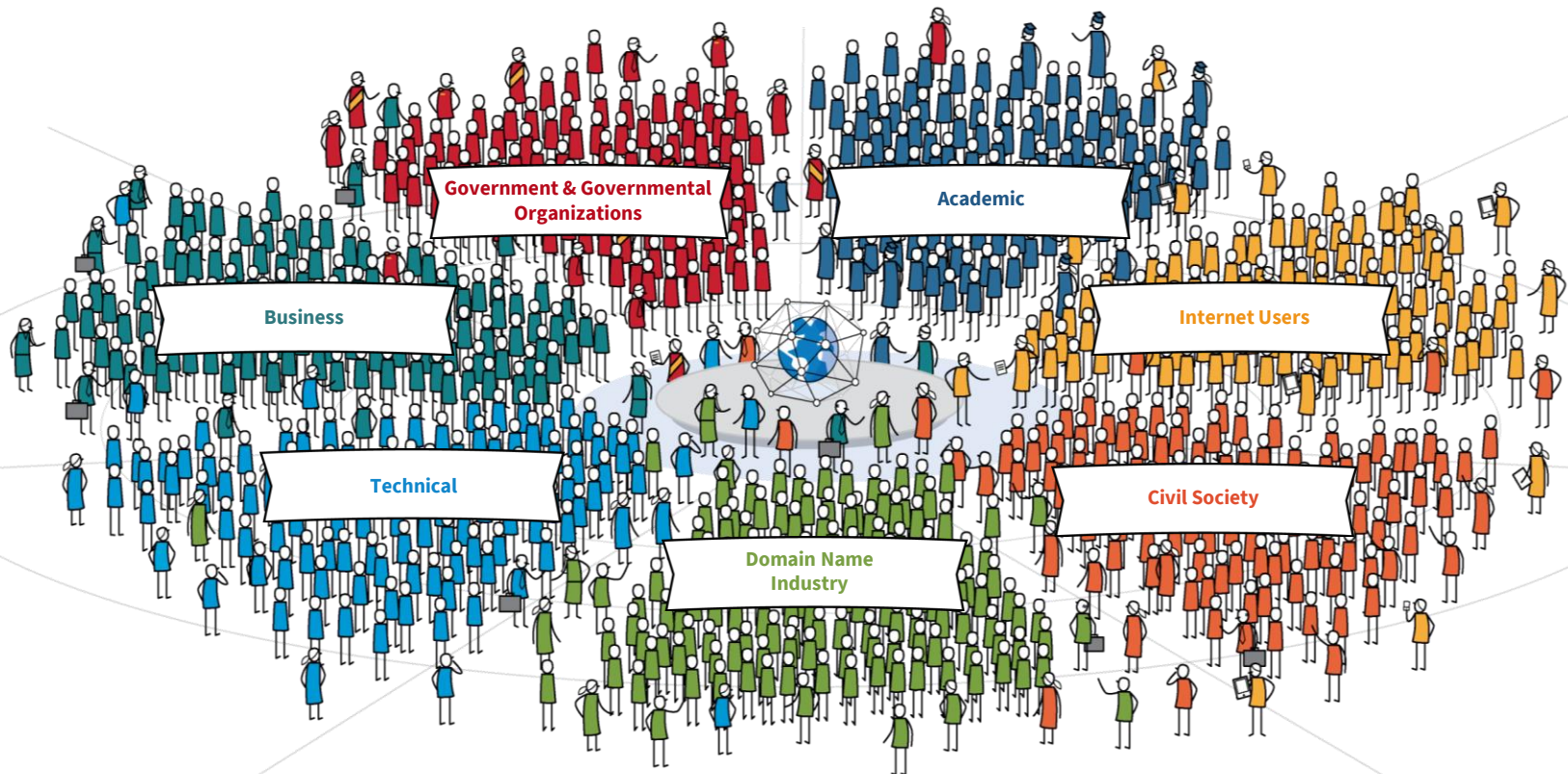

Transition Requirements set by NTIA

NTIA has stated that the transition proposal must have broad community support and address the following four principles:



Support and enhance the multistakeholder model



Maintain the security, stability and resiliency of the Internet DNS



Meet the needs and expectations of the global customers and partners of the IANA services



Maintain the openness of the Internet

NTIA also specified that it will **not** accept a proposal that replaces the NTIA role with a government-led or intergovernmental organization solution.

Two Parallel Processes

The community developed and is following two parallel processes:

IANA Stewardship Transition

Focused on delivering a proposal to transition the stewardship of the IANA functions to the multistakeholder community

Enhancing ICANN Accountability

Focused on ensuring that ICANN remains accountable in the absence of its historical contractual relationship with the U.S. Government

To drive the processes, the community created **multilayered**, **transparent** and **diverse** working groups to foster discussion and within those groups, has developed working methods and systems for determining consensus

Developing Proposals

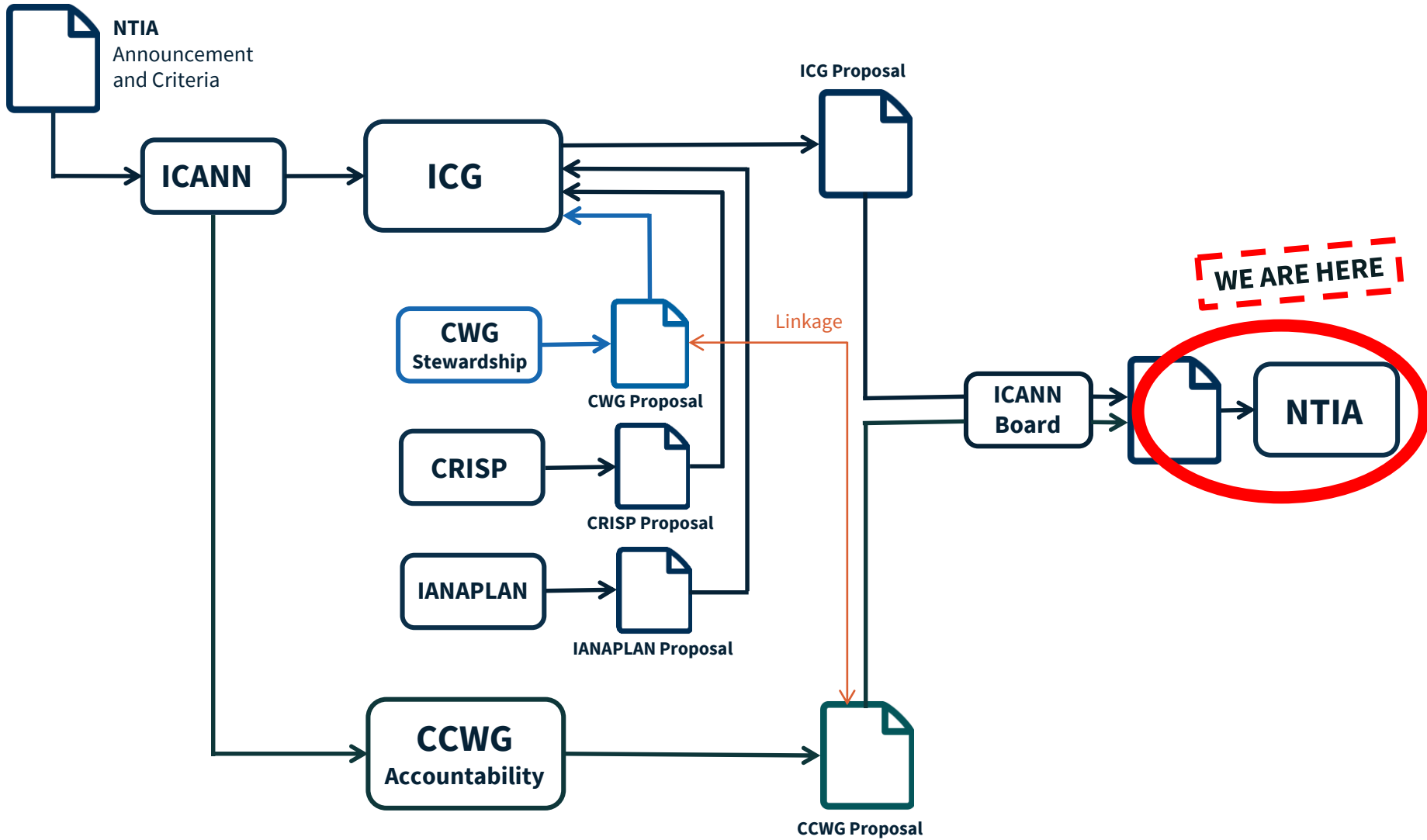

Delivery of IANA Stewardship Transition Package

At ICANN55 in Marrakech, the IANA Stewardship Transition and Enhancing ICANN Accountability proposals were submitted to the ICANN Board



- After launching a short review period, the ICANN Board issued resolutions to transmit both proposals to NTIA at their Board Meeting at the end of the conference
- **The package of proposals was transmitted to NTIA on 10 March 2016**, almost exactly 2 years after the transition was announced

An Unprecedented Multistakeholder Effort

MAJOR WORKING GROUP EFFORTS



800+

Working Hours in Meetings



33,100+

Total Mailing List Exchanges



600+

Total Calls/Meetings

A SUPPORTING GLOBAL DISCUSSION

More than
1,100

* 590+ Webinars

Events around the world where the IANA transition was discussed, debated, organized and planned

Between March 2014 and March 2016

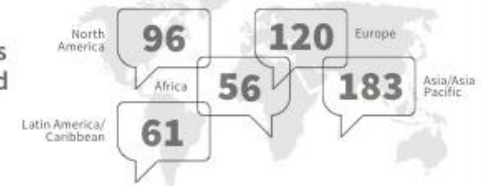

ICG + CCWG ACCOUNTABILITY

ICG

30
Members

Number Resources
CRISP Team

15
Members
= 3 Members x 5 RIRs

Protocol Parameters
IANAPLAN

2,250
Mailing List Exchanges

Domain Names
CWG-Stewardship

153
Members &
Participants

152
Calls and Meetings

CCWG-Accountability

203
Total Participants

28
Members

175
Participants

111
Mailing List Observers

REGIONAL REPRESENTATION



ORGANIZATIONAL STAKEHOLDER REPRESENTATION



THE TWO PARALLEL PROCESSES

IANA Stewardship Transition

Enhancing ICANN Accountability for the Transition

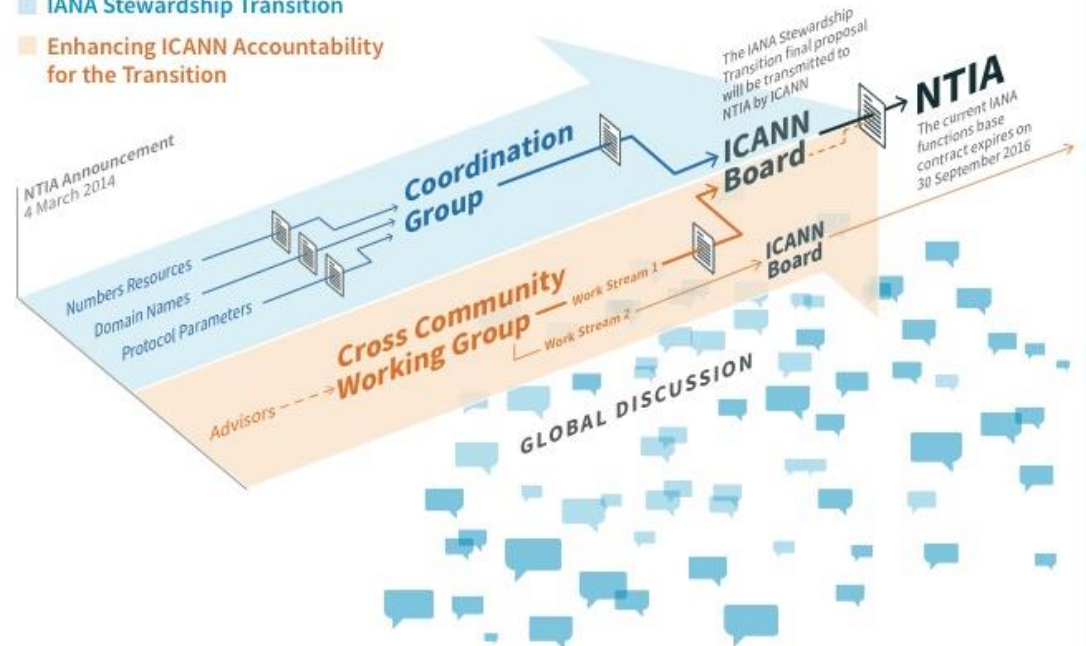

2016 | ICANN | For more information, please visit www.icann.org/stewardship-accountability

Where are we now? What's next?

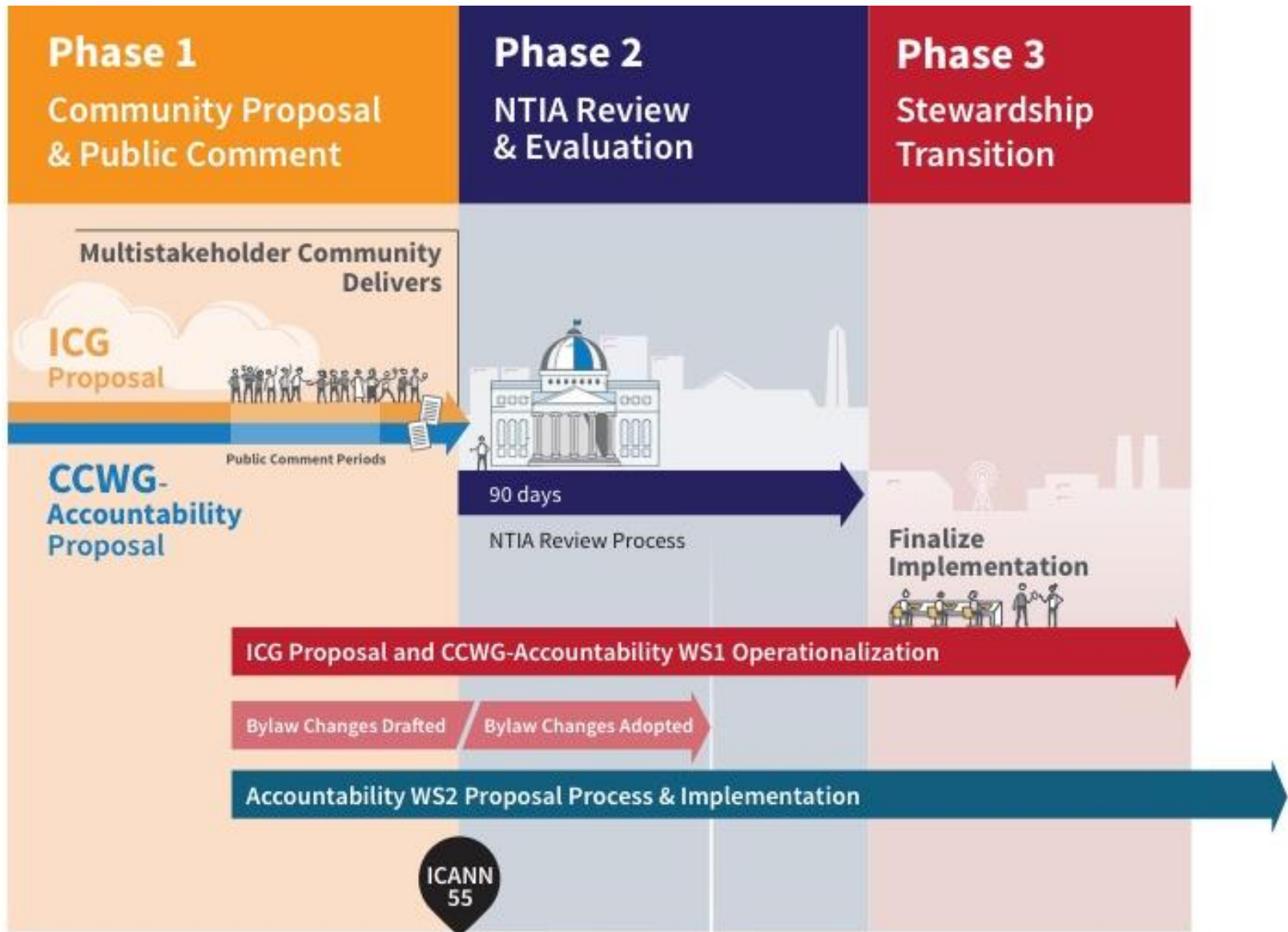

Transition Implementation Reporting



Follow updates on Implementation:
<https://www.icann.org/stewardship-implementation>



GET STARTED

NEWS & MEDIA

POLICY

PUBLIC COMMENT

RESOURCES

COMMUNITY

IANA STEWARDSHIP
& ACCOUNTABILITY

Implementation

IANA Stewardship Transition Implementation

ICANN's objective for implementation of the IANA Stewardship Transition is to be as open and transparent as possible, and to work with the community from the outset of implementation to make sure the transition happens in a timely manner while respecting the IANA contract obligations.

1

Latest Updates & Blog

2

Meetings & Work Sessions

3

Document Archive & Links

Latest Updates & Blog

Be informed of the latest news and blog about the Implementation work

Meetings & Work Sessions

Get access to the future meeting schedule and the past meeting archives

Document Archive & Links

Download any documents related to the implementation work

Root Zone Management System Parallel Testing

90-day Parallel Testing period began on 6 April 2016.

- The Root Zone Administrator (RZA) role currently performed by NTIA will be eliminated upon the successful completion of the IANA Stewardship Transition.
- Used to confirm that the production Root Zone Management System (RZMS) and the parallel test version of the RZMS that has had the NTIA authorization step removed produce identical outputs for every root zone file published.

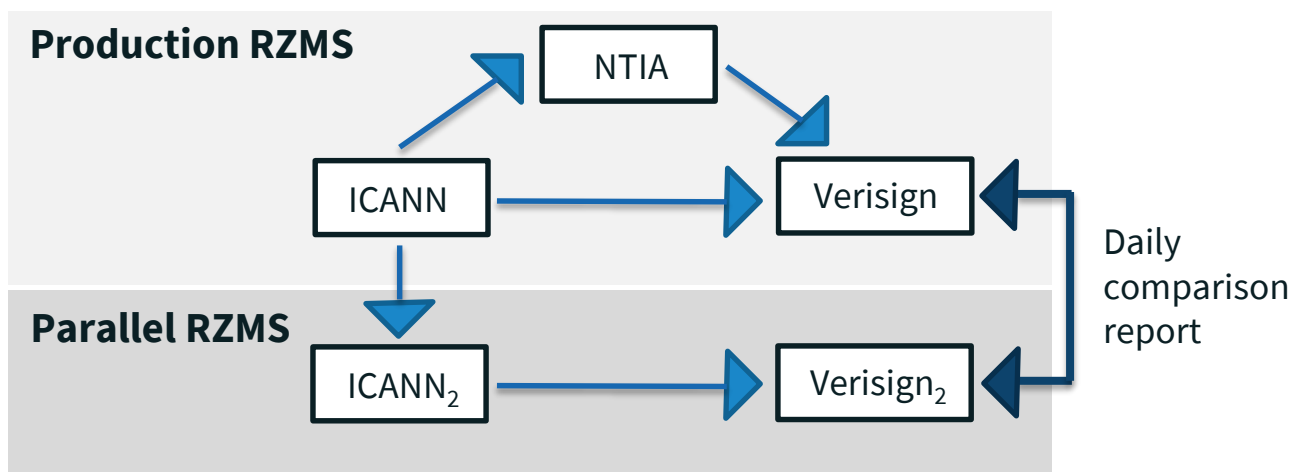

- The authoritative root zone file will continue to be produced by the production RZMS that contains the authorization step performed by NTIA as long as the IANA contract is in place.

Amending ICANN's Bylaws



ICANN's Bylaws are being amended to reflect the recommendations in the ICG and CCWG-Accountability proposals.

- The new Bylaws were drafted by the independent law firms hired to assist the CWG-Stewardship and CCWG-Accountability and ICANN's legal team.
- The lawyers consulted with a Bylaws Coordination Group comprised of both community and ICANN Board members, as well as with the CWG-Stewardship and the CCWG-Accountability.

The new Bylaws are currently posted for a 30-day public comment period from 21 April-21 May 2016.

- This timeline allows for comments to be analyzed and incorporated in time for a tentative 27 May adoption of the Bylaws by the ICANN Board.
- The U.S. Government has stated that prior to their approval of the IANA Stewardship Transition proposals, any new Bylaws must be adopted by the ICANN Board.

Committing to Further Accountability Work in Work Stream 2

The CCWG-Accountability's work consists of two Work Streams:

WORK STREAM 1: Focused on mechanisms enhancing ICANN accountability that must be in place or committed to within the time frame of the IANA Stewardship Transition (**COMPLETED**)

WORK STREAM 2: Focused on addressing accountability topics for which a timeline for developing solutions and full implementation may extend beyond the IANA Stewardship Transition (**IN PROGRESS**)

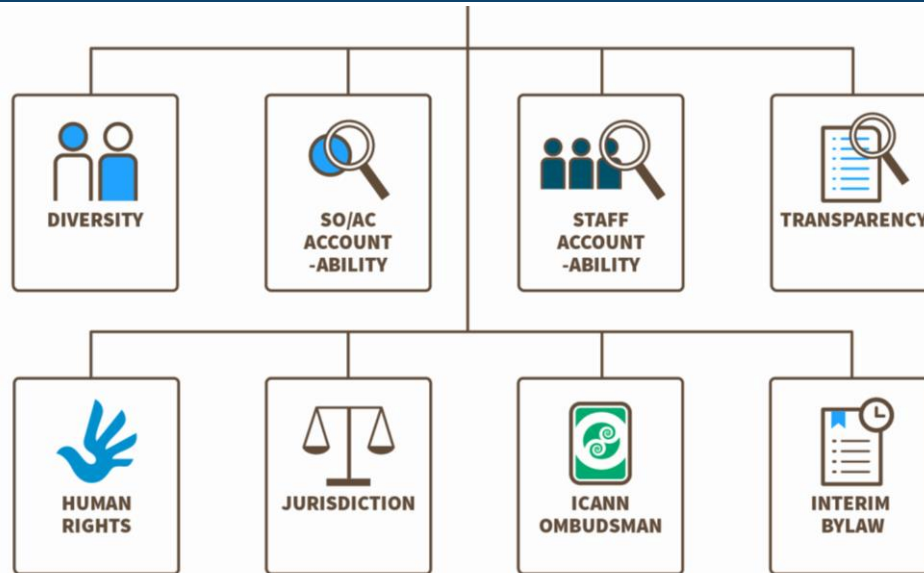



Thank You!